

Informix Product Family
Informix
Version 11.50

IBM Informix Performance Guide



Informix Product Family
Informix
Version 11.50

IBM Informix Performance Guide



Note

Before using this information and the product it supports, read the information in "Notices" on page C-1.

This edition replaces SC27-3618-01.

This document contains proprietary information of IBM. It is provided under a license agreement and is protected by copyright law. The information contained in this publication does not include any product warranties, and any statements provided in this manual should not be interpreted as such.

When you send information to IBM, you grant IBM a nonexclusive right to use or distribute the information in any way it believes appropriate without incurring any obligation to you.

© **Copyright IBM Corporation 1996, 2011.**

US Government Users Restricted Rights – Use, duplication or disclosure restricted by GSA ADP Schedule Contract with IBM Corp.

Contents

Introduction	xi
About this publication	xi
Topics beyond the scope of this publication	xi
Types of users	xii
Software dependencies	xii
Assumptions about your locale.	xii
Demonstration databases	xiii
What's new in performance for Informix, version 11.50	xiii
Example code conventions	xvi
Additional documentation	xvii
Compliance with industry standards	xvii
Chapter 1. Performance basics	1-1
Developing a basic approach to performance measurement and tuning	1-1
Quick start for acceptable performance on a small database	1-2
Performance goals	1-2
Measurements of performance	1-3
Throughput	1-3
Response time	1-5
Cost per transaction	1-7
Resource utilization and performance	1-7
Resource utilization	1-8
CPU utilization	1-9
Memory utilization	1-10
Disk utilization	1-11
Factors that affect resource utilization	1-12
Maintenance of good performance	1-14
Chapter 2. Performance monitoring and the tools you use	2-1
Evaluate the current configuration	2-1
Create a performance history	2-1
The importance of a performance history	2-2
Tools that create a performance history	2-2
Monitor database server resources	2-6
Monitor resources that impact CPU utilization	2-7
Monitor memory utilization.	2-8
Monitor disk I/O utilization	2-10
Monitor transactions.	2-12
Using the onlog utility to monitor transactions	2-12
Using the onstat utility to monitor transactions	2-13
Using ISA to monitor transactions	2-13
Monitor sessions and queries	2-13
Monitoring memory usage for each session	2-14
Using the SET EXPLAIN statement	2-14
Chapter 3. Effect of configuration on CPU utilization.	3-1
UNIX configuration parameters that affect CPU utilization	3-1
UNIX semaphore parameters	3-1
UNIX file-descriptor parameters	3-2
UNIX memory configuration parameters	3-3
Windows configuration parameters that affect CPU utilization	3-3
Configuration parameters and environment variables that affect CPU utilization	3-3
Specifying virtual processor class information.	3-4
Setting the MULTIPROCESSOR configuration parameter when using multiple CPU VPs	3-9
Setting the SINGLE_CPU_VP configuration parameter when using one CPU VP.	3-10

Optimizing access methods	3-10
Limiting PDQ resources in queries	3-11
Limiting the performance impact of CPU-intensive queries	3-12
Limiting the number of PDQ scan threads that can run concurrently	3-12
Configuring poll threads	3-13
Enabling fast polling.	3-16
Network buffer pools	3-16
Network buffers	3-17
Support for private network buffers	3-17
Network buffer size	3-18
Virtual processors and CPU utilization.	3-19
Adding virtual processors	3-19
Monitoring virtual processors.	3-19
CPU virtual processor memory caches.	3-22
Connections and CPU utilization	3-24
Multiplexed connections and CPU utilization	3-24
MaxConnect for multiple connections (UNIX)	3-25

Chapter 4. Effect of configuration on memory utilization 4-1

Shared memory.	4-1
Resident portion of shared memory	4-2
Virtual portion of shared memory	4-2
Message portion of shared memory	4-3
Estimating the size of the resident portion of shared memory	4-3
Estimating the size of the virtual portion of shared memory	4-4
Estimating the size of the message portion of shared memory	4-6
Configuring UNIX shared memory	4-6
Freeing shared memory with onmode -F	4-7
Configuration parameters that affect memory utilization	4-8
Setting the size of the buffer pool, logical-log buffer, and physical-log buffer	4-9
The LOCKS configuration parameter and memory utilization	4-17
The RESIDENT configuration parameter and memory utilization	4-19
The SHMADD and EXTSHMADD configuration parameters and memory utilization	4-19
The SHMTOTAL configuration parameter and memory utilization	4-20
The SHMVIRTSIZE configuration parameter and memory utilization	4-21
The SHMVIRT_ALLOCSEG configuration parameter and memory utilization.	4-21
The STACKSIZE configuration parameter and memory utilization	4-22
Configuration parameters that affect memory caches	4-23
Data-dictionary cache	4-23
Data-distribution cache	4-25
SQL statement cache.	4-29
Prepared statements and the statement cache	4-30
SQL statement cache configuration	4-30
Monitoring and tuning the SQL statement cache	4-32
UDR cache	4-42
Session memory	4-43
Data-replication buffers and memory utilization	4-44
Memory latches	4-44
Monitoring latches with command-line utilities.	4-44
Monitoring latches with ISA	4-45
Monitoring latches with SMI tables.	4-45
Encrypted values	4-45

Chapter 5. Effect of configuration on I/O activity 5-1

Chunk and dbspace configuration	5-1
Associate disk partitions with chunks	5-2
Associate dbspaces with chunks	5-2
Placing system catalog tables with database tables	5-2
I/O for cooked files for dbspace chunks	5-2
Direct I/O (UNIX)	5-3

Direct I/O (Windows)	5-3
Concurrent I/O (AIX only)	5-3
Enabling the direct I/O or concurrent I/O option (UNIX).	5-4
Confirming the use of the direct or concurrent I/O option (UNIX).	5-4
Placement of critical data	5-5
Consider separate disks for critical data components	5-5
Consider mirroring for critical data components	5-5
Configuration parameters that affect critical data	5-8
Configure dbspaces for temporary tables and sort files.	5-8
Creating temporary dbspaces	5-10
Specify temporary tables in the DBSPACETEMP configuration parameter	5-10
Override the DBSPACETEMP parameter for a session	5-11
Estimating temporary space for dbspaces and hash joins.	5-11
PSORT_NPROCS environment variable	5-12
Configure sbspaces for temporary smart large objects.	5-13
Creating temporary sbspaces	5-14
SBSPACETEMP configuration parameter	5-14
Placement of simple large objects	5-14
Advantage of blobspaces over dbspaces	5-15
Blobpage size considerations	5-15
Factors that affect I/O for smart large objects	5-19
Disk layout for sbspaces	5-19
Configuration parameters that affect sbspace I/O	5-20
onspaces options that affect sbspace I/O	5-20
How the Optical Subsystem affects performance	5-24
Environment variables and configuration parameters for the Optical Subsystem	5-24
STAGEBLOB, an Optical Subsystem configuration parameter	5-24
OPCACHEMAX, an Optical Subsystem configuration parameter	5-25
INFORMIXOPCACHE, an Optical Subsystem environment variable	5-25
Table I/O	5-26
Sequential scans	5-26
Light scans	5-26
Unavailable data	5-28
Configuration parameters that affect table I/O	5-28
How RA_PAGES and RA_THRESHOLD affect table I/O	5-28
How DATASKIP affects table I/O	5-29
Background I/O activities	5-29
Configuration parameters that affect checkpoints	5-30
Configuration parameters that affect logging.	5-35
Configuration parameters that affect page cleaning	5-40
Configuration parameters that affect backup and restore.	5-42
Configuration parameters that affect rollback and recovery	5-43
Configuration parameters that affect data replication and auditing	5-44
LRU tuning.	5-46
Chapter 6. Table performance considerations	6-1
Placing tables on disk.	6-1
Isolating high-use tables	6-2
Placing high-use tables on middle partitions of disks	6-2
Using multiple disks	6-3
Backup and restore considerations	6-4
Factors affecting the performance of nonfragmented tables and table fragments	6-5
Estimating table size	6-5
Estimating data pages	6-5
Estimating pages that simple large objects occupy	6-8
Managing the size of first and next extents for the tblspace tblspace	6-10
Managing sbspaces	6-10
Estimating pages that smart large objects occupy	6-10
Improving metadata I/O for smart large objects	6-12
Monitoring sbspaces.	6-13
Changing storage characteristics of smart large objects	6-17

Managing extents.	6-19
Choosing table extent sizes	6-20
Monitoring active tablespaces	6-23
Monitoring the upper limit on extents and extent interleaving	6-23
Reclaiming unused space within an extent	6-27
Managing extent deallocation with the TRUNCATE keyword	6-28
Storing multiple table fragments in a single db space	6-28
Displaying a list of table and index partitions	6-29
Changing tables to improve performance	6-29
Loading and unloading tables	6-29
Dropping indexes for table-update efficiency	6-32
Attaching or detaching fragments	6-32
Altering a table definition	6-32
Denormalize the data model to improve performance	6-39
Shortening rows	6-40
Expelling long strings	6-40
Splitting wide tables.	6-41
Redundant data	6-42
Reduce disk space in tables with variable length rows	6-43
Reduce disk space by compressing tables and fragments.	6-44

Chapter 7. Indexes and index performance considerations 7-1

Types of indexes	7-1
B-tree indexes	7-1
R-tree indexes	7-2
Indexes that DataBlade modules provide	7-2
Estimating index pages	7-3
Index extent sizes	7-3
Estimating conventional index pages.	7-4
Managing indexes	7-6
Space costs of indexes	7-6
Time costs of indexes	7-7
Unclaimed index space	7-7
Indexes on columns	7-8
Nonunique indexes	7-10
Creating and dropping an index in an online environment	7-11
When you cannot create or drop indexes online	7-12
Creating attached indexes in an online environment	7-13
Limiting memory allocation while creating indexes online	7-13
Improving performance for index builds	7-13
Estimating memory needed for sorting	7-14
Estimating temporary space for index builds	7-14
Storing multiple index fragments in a single db space.	7-15
Improving performance for index checks	7-15
Indexes on user-defined data types	7-16
Defining indexes for user-defined data types	7-16
Using an index that a DataBlade module provides.	7-22
Choosing operator classes for indexes	7-22

Chapter 8. Locking 8-1

Locks	8-1
Locking granularity	8-1
Row and key locks	8-1
Page locks	8-2
Table locks	8-3
Database locks	8-3
Configuring the lock mode	8-4
Setting the lock mode to wait	8-5
Locks with the SELECT statement	8-5
Isolation level	8-5

Locking nonlogging tables	8-8
Update cursors	8-8
Locks placed with INSERT, UPDATE, and DELETE statements	8-10
The internal lock table	8-10
Monitoring locks	8-11
Configuring and managing lock usage.	8-12
Monitoring lock waits and lock errors	8-13
Monitoring the number of free locks	8-14
Monitoring deadlocks	8-14
Monitoring isolation levels that sessions use	8-15
Locks for smart large objects	8-16
Byte-range locking	8-16
Lock promotion	8-19
Dirty Read isolation level and smart large objects	8-19
Chapter 9. Fragmentation guidelines	9-1
Planning a fragmentation strategy	9-1
Fragmentation goals	9-2
Examining your data and queries.	9-4
Considering physical fragmentation factors	9-5
Distribution schemes	9-6
Choosing a distribution scheme	9-6
Designing an expression-based distribution scheme.	9-7
Suggestions for improving fragmentation	9-8
Strategy for fragmenting indexes	9-9
Attached indexes	9-10
Detached indexes.	9-11
Restrictions on indexes for fragmented tables	9-12
Strategy for fragmenting temporary tables	9-12
Distribution schemes that eliminate fragments	9-13
Fragmentation expressions for fragment elimination	9-13
Query expressions for fragment elimination	9-14
Effectiveness of fragment elimination	9-15
Improve the performance of operations that attach and detach fragments	9-18
Improving ALTER FRAGMENT ATTACH performance	9-19
Improving ALTER FRAGMENT DETACH performance	9-25
Forcing out transactions when altering table fragments	9-26
Monitoring fragment use	9-27
Monitoring fragmentation with the onstat -g ppf command.	9-27
Monitoring fragmentation with SET EXPLAIN output	9-28
Chapter 10. Queries and the query optimizer	10-1
The query plan	10-1
The access plan	10-1
The join plan	10-2
Example of query-plan execution	10-4
Query plans that include an index self-join path	10-7
Query plan evaluation	10-9
Report that shows the query plan chosen by the optimizer	10-9
Sample query plan reports	10-11
XML query plans in IBM Data Studio	10-18
Factors that affect the query plan	10-18
Statistics held for the table and index.	10-18
Filters in the query	10-19
Indexes for evaluating a filter	10-20
Effect of PDQ on the query plan	10-21
Effect of OPTCOMPIND on the query plan.	10-21
Effect of available memory on the query plan	10-22
Time costs of a query	10-22
Memory-activity costs	10-22

Sort-time costs	10-22
Row-reading costs	10-24
Sequential access costs.	10-24
Nonsequential access costs	10-25
Index lookup costs	10-25
In-place ALTER TABLE costs	10-26
View costs	10-26
Small-table costs.	10-27
Data-mismatch costs	10-27
Encrypted-value costs	10-28
GLS functionality costs	10-28
Network-access costs	10-28
Optimization when SQL is within an SPL routine.	10-29
SQL optimization	10-29
Execution of an SPL routine	10-32
SPL routine executable format stored in UDR cache	10-32
Trigger execution	10-33
Performance implications for triggers.	10-34
Chapter 11. Optimizer directives	11-1
What optimizer directives are.	11-1
Optimizer directives that are embedded in queries.	11-1
External optimizer directives	11-1
Reasons to use optimizer directives.	11-2
Preparation for using directives	11-3
Guidelines for using directives	11-3
Types of directives that are included in SQL statements	11-3
Access-method directives	11-4
Join-order directives	11-5
Join-plan directives	11-6
Optimization-goal directives	11-7
Example of directives that can alter a query plan	11-7
EXPLAIN directives	11-10
Configuration parameters and environment variables for optimizer directives	11-11
Optimizer directives and SPL routines	11-11
Forcing reoptimization to avoid an index and previously prepared statement problem	11-12
External optimizer directives.	11-13
Creating and saving external directives	11-14
Enabling external directives	11-14
Deleting external directives	11-15
Chapter 12. Parallel database query (PDQ)	12-1
What PDQ is	12-1
Structure of a PDQ query	12-1
Database server operations that use PDQ.	12-2
Parallel delete operations	12-2
Parallel insert operations	12-2
Parallel index builds.	12-3
Parallel user-defined routines.	12-4
Hold cursors that use PDQ	12-4
SQL operations that do not use PDQ	12-4
Update statistics operations affected by PDQ	12-4
SPL routines and triggers and PDQ.	12-5
Correlated and uncorrelated subqueries	12-5
OUTER index joins and PDQ.	12-5
Remote tables used with PDQ	12-5
The Memory Grant Manager	12-6
The allocation of resources for parallel database queries	12-7
Limiting the priority of decision-support queries	12-7
Adjusting the amount of memory for DSS and PDQ queries	12-10

Limiting the number of concurrent scans	12-11
Limiting the maximum number of PDQ queries	12-12
Managing PDQ queries	12-12
Analyzing query plans with SET EXPLAIN output	12-12
Influencing the choice of a query plan	12-12
Setting the PDQ priority dynamically.	12-13
User control of PDQ resources	12-13
DBA control of resources for PDQ and DSS queries	12-13
Monitoring resources used for PDQ and DSS queries	12-14
Monitoring PDQ resources by using the onstat Utility	12-14
Identifying parallel scans in SET EXPLAIN output	12-19

Chapter 13. Improving individual query performance 13-1

Test queries using a dedicated test system	13-1
Display the query plan	13-1
Improve filter selectivity	13-2
Filters with user-defined routines	13-2
Avoid some filters	13-2
Use join filters and post-join filters	13-3
Automatic statistics updating	13-6
How AUS works	13-7
AUS expiration policies.	13-8
Viewing AUS statements	13-10
Rescheduling AUS	13-10
Disabling AUS	13-11
Update statistics when they are not generated automatically	13-11
Updating the number of rows	13-12
Dropping data distributions	13-13
Creating data distributions	13-13
Updating statistics for join columns	13-15
Updating statistics for columns with user-defined data types.	13-16
Updating statistics on very large databases	13-17
Displaying data distributions	13-17
Improving the performance of UPDATE STATISTICS	13-19
Improve performance by adding or removing indexes	13-19
Replace autoindexes with permanent indexes	13-19
Use composite indexes	13-19
Indexes for data warehouse applications.	13-20
Configure B-tree scanner information to improve transaction processing	13-21
Determine the amount of free space in an index page	13-28
Optimizer estimates of distributed queries	13-28
Buffer data transfers for a distributed query	13-29
The query plan of a distributed query	13-29
Improve sequential scans	13-30
Enable view folding to improve query performance	13-30
Reduce the join and sort operations	13-31
Avoid or simplify sort operations	13-31
Use parallel sorts	13-31
Use temporary tables to reduce sorting scope	13-32
More memory for queries with hash joins, aggregates, and other memory-intensive elements	13-33
Optimize user-response time for queries.	13-34
Optimization level	13-34
Optimization goals	13-34
Optimize queries for user-defined data types	13-37
Parallel UDRs	13-37
Selectivity and cost functions	13-38
User-defined statistics for UDTs	13-39
Negator functions	13-39
SQL statement cache	13-39
When to use the SQL statement cache	13-40
Using the SQL statement cache	13-41

Monitoring memory usage for each session	13-42
Monitoring usage of the SQL statement cache	13-45
Monitor sessions and threads	13-46
Monitor sessions and threads with onstat commands	13-47
Monitor sessions and threads with ON-Monitor (UNIX)	13-51
Monitor sessions and threads with ISA	13-52
Monitor sessions and threads with SMI tables	13-52
Monitor transactions	13-53
Display information about transactions	13-53
Display information about transaction locks	13-54
Display statistics on user sessions	13-55
Display statistics on sessions executing SQL statements.	13-56

Chapter 14. The onperf utility on UNIX 14-1

Overview of the onperf utility	14-1
Basic onperf utility functions	14-1
onperf utility tools	14-3
Requirements for running the onperf utility	14-3
Starting the onperf utility and exiting from it	14-4
The onperf user interface	14-5
Graph tool	14-5
Query-tree tool	14-11
Status tool	14-11
Activity tools	14-12
Why you might want to use onperf	14-12
Routine monitoring with onperf	14-13
Diagnosing sudden performance loss	14-13
Diagnosing performance degradation	14-13
onperf utility metrics	14-13
Database server metrics	14-13
Disk-chunk metrics	14-15
Disk-spindle metrics	14-15
Physical-processor metrics	14-15
Virtual-processor metrics	14-16
Session metrics	14-16
Tbospace metrics	14-17
Fragment metrics	14-18

Appendix A. Case studies and examples A-1

Case study of a situation in which disks are overloaded	A-1
---	-----

Appendix B. Accessibility B-1

Accessibility features for IBM Informix products.	B-1
Accessibility features	B-1
Keyboard navigation	B-1
Related accessibility information	B-1
IBM and accessibility	B-1
Dotted decimal syntax diagrams	B-1

Notices C-1

Trademarks	C-3
----------------------	-----

Index X-1

Introduction

This introduction provides an overview of the information in this publication and describes the conventions it uses.

About this publication

This publication provides information about how to configure and operate IBM® Informix® to improve overall system throughput and to improve the performance of SQL queries. This publication also includes information about performance tuning issues and methods, fragmentation guidelines, and a complete description of the **onperf** utility

Information in this publication can help you perform the following tasks:

- Monitor system resources that are critical to performance
- Identify database activities that affect these critical resources
- Identify and monitor queries that are critical to performance
- Use the database server utilities (especially **onperf**, **ISA** and **onstat**) for performance monitoring and tuning
- Eliminate performance bottlenecks by:
 - Balancing the load on system resources
 - Adjusting the configuration parameters or environment variables of your database server
 - Adjusting the arrangement of your data
 - Allocating resources for decision-support queries
 - Creating indexes to speed up retrieval of your data

Performance measurement and tuning encompass a broad area of research and practice and can involve information beyond the scope of this publication.

Performance issues related to dimensional databases and data warehouse queries are described in the *IBM Informix Data Warehouse Guide*.

Related concepts

 Performance tuning dimensional databases (Data Warehouse Guide)

Topics beyond the scope of this publication

Attempts to balance the workload often produce a succession of moderate performance improvements. Sometimes the improvements are dramatic. However, in some situations a load-balancing approach is not enough. The following types of situations might require measures beyond the scope of this publication:

- Application programs that require modification to make better use of database server or operating-system resources
- Applications that interact in ways that impair performance
- A host computer that might be subject to conflicting uses
- A host computer with capacity that is inadequate for the evolving workload
- Network performance problems that affect client/server or other applications

No amount of database tuning can correct these situations. Nevertheless, they are easier to identify and resolve when the database server is configured properly.

Important: Although broad performance considerations also include reliability and data availability as well as improved response time and efficient use of system resources, this publication discusses only response time and system resource use. For discussions of improved database server reliability and data availability, see information about switchover, mirroring, and high availability in your IBM Informix Administrator's Guide. For information about backup and restore, see the IBM Informix Backup and Restore Guide.

Types of users

This publication is written for the following users:

- Database administrators
- Database server administrators
- Database-application programmers
- Performance engineers

This publication assumes that you have the following background:

- A working knowledge of your computer, your operating system, and the utilities that your operating system provides
- Some experience working with relational databases or exposure to database concepts
- Some experience with computer programming
- Some experience with database server administration, operating-system administration, or network administration

If you have limited experience with relational databases, SQL, or your operating system, see the IBM Informix Getting Started Guide for your database server for a list of supplementary titles.

Software dependencies

This publication assumes that you are using IBM Informix, Version 11.50.

Assumptions about your locale

IBM Informix products can support many languages, cultures, and code sets. All the information related to character set, collation, and representation of numeric data, currency, date, and time is brought together in a single environment, called a Global Language Support (GLS) locale.

This manual assumes that you use the U.S. 8859-1 English locale as the default locale. The default is **en_us.8859-1** (ISO 8859-1) on UNIX platforms or **en_us.1252** (Microsoft 1252) for Windows environments. This locale supports U.S. English format conventions for date, time, and currency, and also supports the ISO 8859-1 or Microsoft 1252 code set, which includes the ASCII code set plus many 8-bit characters such as é, è, and ñ.

If you plan to use nondefault characters in your data or your SQL identifiers, or if you want to conform to the nondefault collation rules of character data, you need to specify the appropriate nondefault locale.

For instructions on how to specify a nondefault locale, additional syntax, and other considerations related to GLS locales, see the IBM Informix GLS User's Guide.

Demonstration databases

The DB-Access utility, which is provided with your IBM Informix database server products, includes one or more of the following demonstration databases:

- The **stores_demo** database illustrates a relational schema with information about a fictitious wholesale sporting-goods distributor. Many examples in IBM Informix manuals are based on the **stores_demo** database.
- The **superstores_demo** database illustrates an object-relational schema. The **superstores_demo** database contains examples of extended data types, type and table inheritance, and user-defined routines.

For information about how to create and populate the demonstration databases, see the IBM Informix DB-Access User's Guide. For descriptions of the databases and their contents, see information in the IBM Informix Guide to SQL: Reference.

The scripts that you use to install the demonstration databases reside in the **\$INFORMIXDIR/bin** directory on UNIX platforms and in the **%INFORMIXDIR%\bin** directory in Windows environments.

What's new in performance for Informix, version 11.50

This publication includes information about new features and changes in existing functionality.

The following changes and enhancements are relevant to this publication. For a comprehensive list of all new features for this release, see the *IBM Informix Getting Started Guide*.

Table 1. What's new in the IBM Informix Performance Guide for Version 11.50xC9

Overview	Reference
<p>Reserving memory for critical activities</p> <p>You can enable the server to reserve a specific amount of memory for use when critical activities (such as rollback activities) are needed and the server has limited free memory. If you enable the new LOW_MEMORY_RESERVE configuration parameter by setting it to a specified value in kilobytes, the critical activities can complete even when you get out-of-memory errors. You can also dynamically adjust the value of the LOW_MEMORY_RESERVE configuration parameter with the onmode -wm or -wf command.</p>	<p>“The LOW_MEMORY_RESERVE configuration parameter and memory utilization” on page 4-17</p> <p>LOW_MEMORY_RESERVE configuration parameter (Administrator's Reference)</p>
<p>Configuring the server response to low memory</p> <p>You can configure the actions that the server takes to continue processing when memory is critically low. You can specify the criteria for terminating sessions based on idle time, memory usage, and other factors so that the targeted application can continue and avoid out-of-memory problems. Configuring the low memory response is useful for embedded applications that have memory limitations.</p>	<p>Configure the server response when memory is critically low (Administrator's Guide)</p> <p>LOW_MEMORY_MGR configuration parameter (Administrator's Reference)</p>

Table 2. What's new in the IBM Informix Performance Guide for Version 11.50xC8

Overview	Reference
<p>New editions and product names</p> <p>IBM Informix Dynamic Server editions were withdrawn and new Informix editions are available. Some products were also renamed. The publications in the Informix library pertain to the following products:</p> <ul style="list-style-type: none"> • IBM Informix database server, formerly known as IBM Informix Dynamic Server (IDS) • IBM OpenAdmin Tool (OAT) for Informix, formerly known as OpenAdmin Tool for Informix Dynamic Server (IDS) • IBM Informix SQL Warehousing Tool, formerly known as Informix Warehouse Feature 	<p>For more information about the Informix product family, go to http://www.ibm.com/software/data/informix/.</p>

Table 3. What's New in the IBM Informix Performance Guide for Version 11.50.xC6

Overview	Reference
<p>Light Scans on Tables</p> <p>You can now enable Informix to perform light scans on compressed tables, tables with rows that are larger than a page, and tables with any data, including VARCHAR, LVARCHAR, and NVARCHAR data. The server does not scan pieces of a row (such as smart large objects) that are stored outside of the row.</p> <p>To enable light scans, set the BATCHEDREAD_TABLE configuration parameter to 1. You can also use the IFX_BATCHEDREAD_TABLE environment option of the SET ENVIRONMENT statement to change the value of the BATCHEDREAD_TABLE configuration parameter for a session.</p>	<p>“Light scans” on page 5-26</p>
<p>An ALTER FRAGMENT Operation Can Now Force Out Transactions to Get Exclusive Access to Tables</p> <p>The ALTER FRAGMENT operation requires exclusive access and exclusive locks on all the tables involved in the operation. Now a DBA can force out other transactions that opened or locked the tables involved in an ALTER FRAGMENT ON TABLE operation. When the FORCE_DDL_EXEC environment option is enabled, the ALTER FRAGMENT ON TABLE operation waits to get exclusive access to the table, as specified by the lock mode wait value. If necessary, the server rolls back the transactions that have access or locks on the tables involved in the operation until the timeout value of the FORCE_DDL_EXEC environment option is reached.</p>	<p>“Forcing out transactions when altering table fragments” on page 9-26</p> <p><i>IBM Informix Guide to SQL: Syntax</i></p>

Table 4. What's New in the IBM Informix Performance Guide for Version 11.50.xC4

Overview	Reference
<p>Enable Concurrent I/O to Improve Performance on AIX® Operating Systems</p> <p>You can now improve the performance of cooked files used for dbspace chunks by setting concurrent I/O, which allows multiple reads and writes to a file at the same time. Concurrent I/O provides performance improvements over direct I/O because it avoids the serialization of noncompeting reads and writes from normal file-system locking. Similar to direct I/O, concurrent IO avoids file system buffering. Concurrent I/O can be especially beneficial when you have a file striped across multiple disks. To enable concurrent I/O on AIX, set the DIRECT_IO configuration parameter to 2.</p>	<p>"I/O for cooked files for dbspace chunks" on page 5-2</p> <p>"Concurrent I/O (AIX only)" on page 5-3</p> <p>DIRECT_IO configuration parameter information in the <i>IBM Informix Administrator's Reference</i></p>

Table 5. What's New in the IBM Informix Performance Guide for Version 11.50.xC3

Overview	Reference
<p>Changing the Size of the First Extent of a Table</p> <p>When you create a table, you specify a first extent size based on the eventual estimated size of the table. If the table becomes larger or smaller than that estimate, you might want to change the size of the first extent to avoid either having too many extents or creating extents that are larger than necessary. You can now change the size of the first extent of a table in a dbspace. When you change the size of the first extent, the database server records the change (in the system catalog and on the partition page), but only makes the actual change when the table is rebuilt or a new partition or fragment is created.</p>	<p>"Extent sizes for tables in a dbspace" on page 6-20</p>

Table 6. What's New in the IBM Informix Performance Guide for Version 11.50.xC2

Overview	Reference
<p>Controlling I/O of B-Tree Indexes with Compression Levels</p> <p>B-tree scanners can now compress indexes by merging two partially used index pages if the data on those pages totals a set level (low, medium, or high). You can specify the index compression level by modifying the value of the compression field of the BTSCANNER configuration parameter option, by running an onmode -C compression value command, or by running an SQL administration API function with the SET INDEX COMPRESSION command.</p>	<p>"B-tree scanner index compression levels and transaction processing performance" on page 13-26</p>

Table 7. What's New in the IBM Informix Performance Guide for Version 11.50.xC1

Overview	Reference
<p>The EXTDIRECTIVES session environment option of the SET ENVIRONMENT statement</p> <p>You can use the EXTDIRECTIVES session environment option to control whether external directives are enabled, disabled, or have default behavior during a session.</p>	<p>"Enabling external directives" on page 11-14</p>

Table 7. What's New in the IBM Informix Performance Guide for Version 11.50.xC1 (continued)

Overview	Reference
<p>The EXPLAIN_SQL routine</p> <p>This routine prepares a query and returns a query plan in XML. The IBM Data Studio Administration Edition can use the EXPLAIN_SQL routine to obtain a query plan in XML format, interpret the XML, and render the plan visually.</p>	<p>“XML query plans in IBM Data Studio” on page 10-18</p>
<p>Updating Table Statistics with AUS Scheduler Tasks</p> <p>The new Auto Update Statistics (AUS) scheduler tasks can improve the performance of the database server by regularly providing the query optimizer with updated table statistics as the basis for efficient query plans.</p> <ol style="list-style-type: none"> 1. Use the Auto Update Statistics Evaluation task to generate a prioritized set of UPDATE STATISTICS statements. Built-in policies specify criteria for identifying the tables whose column distributions should be recalculated, but you can modify these default policies. 2. Use the Auto Update Statistics Refresh task to run the statements during a recurring time interval that you set. 	<p>“Automatic statistics updating” on page 13-6</p>

Example code conventions

Examples of SQL code occur throughout this publication. Except as noted, the code is not specific to any single IBM Informix application development tool.

If only SQL statements are listed in the example, they are not delimited by semicolons. For instance, you might see the code in the following example:

```
CONNECT TO stores_demo
...

DELETE FROM customer
  WHERE customer_num = 121
...

COMMIT WORK
DISCONNECT CURRENT
```

To use this SQL code for a specific product, you must apply the syntax rules for that product. For example, if you are using an SQL API, you must use EXEC SQL at the start of each statement and a semicolon (or other appropriate delimiter) at the end of the statement. If you are using DB–Access, you must delimit multiple statements with semicolons.

Tip: Ellipsis points in a code example indicate that more code would be added in a full application, but it is not necessary to show it to describe the concept being discussed.

For detailed directions on using SQL statements for a particular application development tool or SQL API, see the documentation for your product.

Additional documentation

Documentation about this release of IBM Informix products is available in various formats.

You can access or install the product documentation from the Quick Start CD that is shipped with Informix products. To get the most current information, see the Informix information centers at ibm.com[®]. You can access the information centers and other Informix technical information such as technotes, white papers, and IBM Redbooks[®] publications online at <http://www.ibm.com/software/data/sw-library/>.

Compliance with industry standards

IBM Informix products are compliant with various standards.

IBM Informix SQL-based products are fully compliant with SQL-92 Entry Level (published as ANSI X3.135-1992), which is identical to ISO 9075:1992. In addition, many features of IBM Informix database servers comply with the SQL-92 Intermediate and Full Level and X/Open SQL Common Applications Environment (CAE) standards.

The IBM Informix Geodetic DataBlade[®] Module supports a subset of the data types from the *Spatial Data Transfer Standard (SDTS)—Federal Information Processing Standard 173*, as referenced by the document *Content Standard for Geospatial Metadata*, Federal Geographic Data Committee, June 8, 1994 (FGDC Metadata Standard).

IBM Informix Dynamic Server (IDS) Enterprise Edition, Version 11.50 is certified under the Common Criteria. For more information, see *Common Criteria Certification: Requirements for IBM Informix Dynamic Server*, which is available at <http://www.ibm.com/e-business/linkweb/publications/servlet/pbi.wss?CTY=US&FNC=SRX&PBL=SC23-7690-00>.

Chapter 1. Performance basics

Performance measurement and tuning issues and methods are relevant to daily database server administration and query execution.

Performance measurement and tuning encompass a broad area of research and practice and can involve information beyond the scope of this publication. For more information about the types of information contained in the publication and the topics that are beyond the scope of this publication, see “About this publication” on page xi.

For a description of the database server parallel processing and the applications that use the database server, see the *IBM Informix Getting Started Guide*.

These topics:

- Describe a basic approach for performance measurement and tuning
- Provide guidelines for a quick start to obtain acceptable initial performance on a small database
- Describe roles in maintaining good performance

Developing a basic approach to performance measurement and tuning

To maintain optimum performance for your database applications, develop a plan for measuring system performance, making adjustments to maintain good performance and taking corrective measures when performance degrades. Regular, specific measurements can help you to anticipate and correct performance problems.

By recognizing problems early, you can prevent them from affecting users significantly. Early indications of a performance problem are often vague; users might report that the system seems sluggish. Users might complain that they cannot get all their work done, that transactions take too long to complete, that queries take too long to process, or that the application slows down at certain times during the day.

To determine the nature of the problem, you must measure the actual use of system resources and evaluate the results.

Users typically report performance problems in the following situations:

- Response times for transactions or queries take longer than expected.
- Transaction throughput is insufficient to complete the required workload.
- Transaction throughput decreases.

An iterative approach to optimizing database server performance is recommended. If repeating the steps found in the following list does not produce the desired improvement, insufficient hardware resources or inefficient code in one or more client applications might be causing the problem.

To optimize performance:

1. Establish performance objectives.
2. Take regular measurements of resource utilization and database activity.

3. Identify symptoms of performance problems: disproportionate utilization of CPU, memory, or disks.
4. Tune the operating-system configuration.
5. Tune the database server configuration.
6. Optimize the chunk and dbspace configuration, including placement of logs, sort space, and space for temporary tables and sort files.
7. Optimize the table placement, extent sizing, and fragmentation.
8. Improve the indexes.
9. Optimize background I/O activities, including logging, checkpoints, and page cleaning.
10. Schedule backup and batch operations for off-peak hours.
11. Optimize the implementation of the database application.
12. Repeat steps 2 through 11.

Quick start for acceptable performance on a small database

If you have a small database with each table residing on only one disk and using only one CPU virtual processor, you can take specific measurements to help you anticipate and correct performance problems.

To achieve acceptable initial performance on a small database:

1. Generate statistics of your tables and indexes to provide information to the query optimizer to enable it to choose query plans with the lowest estimated cost.

These statistics are a minimum starting point to obtain good performance for individual queries. For guidelines, see “Update statistics when they are not generated automatically” on page 13-11. To see the query plan that the optimizer chooses for each query, see “Display the query plan” on page 13-1.
2. If you want a query to run in parallel with other queries, you must turn on the Parallel Database Query (PDQ) feature.

Without table fragmentation across multiple disks, parallel scans do not occur. With only one CPU virtual processor, parallel joins or parallel sorts do not occur. However, PDQ priority can obtain more memory to perform the sort. For more information, see Chapter 12, “Parallel database query (PDQ),” on page 12-1.
3. If you want to mix online transaction processing (OLTP) and decision-support system (DSS) query applications, you can control the amount of resources a long-running query can obtain so that your OLTP transactions are not affected.

For information about how to control PDQ resources, see “The allocation of resources for parallel database queries” on page 12-7.
4. Monitor sessions and drill down into various details to improve the performance of individual queries.

For information about the various tools and session details to monitor, see “Monitoring memory usage for each session” on page 13-42 and “Monitor sessions and threads” on page 13-46.

Performance goals

When you plan for measuring and tuning performance, you should consider performance goals and determine which goals are the most important.

Many considerations go into establishing performance goals for the database server and the applications that it supports. Be clear and consistent about articulating performance goals and priorities, so that you can provide realistic and consistent expectations about the performance objectives for your application. Consider the following questions when you establish performance goals:

- Is your top priority to maximize transaction throughput, minimize response time for specific queries, or achieve the best overall mix?
- What sort of mix between simple transactions, extended decision-support queries, and other types of requests does the database server typically handle?
- At what point are you willing to trade transaction-processing speed for availability or the risk of loss for a particular transaction?
- Is this database server instance used in a client/server configuration? If so, what are the networking characteristics that affect its performance?
- What is the maximum number of users that you expect?
- Is your configuration limited by memory, disk space, or CPU resources?

The answers to these questions can help you set realistic performance goals for your resources and your mix of applications.

Measurements of performance

You can use throughput, response time, cost per transaction, and resource utilization measures to evaluate performance.

Throughput, response time, and cost per transaction are described in the topics that follow.

Resource utilization can have one of two meanings, depending on the context. The term can refer to the amount of a resource that a particular operation requires or uses, or it can refer to the current load on a particular system component. The term is used in the former sense to compare approaches for accomplishing a given task. For instance, if a given sort operation requires 10 megabytes of disk space, its resource utilization is greater than another sort operation that requires only 5 megabytes of disk space. The term is used in the latter sense to refer, for instance, to the number of CPU cycles that are devoted to a particular query during a specific time interval.

For a discussion about the performance impact of different load levels on various system components, see “Resource utilization and performance” on page 1-7.

Throughput

Throughput measures the overall performance of the system. For transaction processing systems, throughput is typically measured in *transactions per second* (TPS) or *transactions per minute* (TPM).

Throughput depends on the following factors:

- The specifications of the host computer
- The processing overhead in the software
- The layout of data on disk
- The degree of parallelism that both hardware and software support
- The types of transactions being processed

Ways to measure throughput

The best way to measure throughput for an application is to include code in the application that logs the time stamps of transactions as they commit.

If your application does not provide support for measuring throughput directly, you can obtain an estimate by tracking the number of COMMIT WORK statements that the database server logs during a given time interval. You can use the **onlog** utility to obtain a listing of logical-log records that are written to log files. You can use information from this command to track insert, delete, and update operations as well as committed transactions. However, you cannot obtain information stored in the logical-log buffer until that information is written to a log file.

If you need more immediate feedback, you can use **onstat -p** to gather an estimate. You can use the SET LOG statement to set the logging mode to unbuffered for the databases that contain tables of interest. You can also use the trusted auditing facility in the database server to record successful COMMIT WORK events or other events of interest in an audit log file. Using the auditing facility can increase the overhead involved in processing any audited event, which can reduce overall throughput.

Related information

 [Auditing data security \(Security Guide\)](#)

Standard throughput benchmarks

The Transaction Processing Performance Council (TPC) provides standard benchmarks that allow reasonable throughput comparisons across hardware configurations and database servers. IBM is an active member in good standing of the TPC.

The TPC provides the following standardized benchmarks for measuring throughput:

- TPC-A
This benchmark is used for simple online transaction-processing (OLTP) comparisons. It characterizes the performance of a simple transaction-processing system, emphasizing update-intensive services. TPC-A simulates a workload that consists of multiple user sessions connected over a network with significant disk I/O activity.
- TPC-B
This benchmark is used for stress-testing peak database throughput. It uses the same transaction load as TPC-A but removes any networking and interactive operations to provide a best-case throughput measurement.
- TPC-C
This benchmark is used for complex OLTP applications. It is derived from TPC-A and uses a mix of updates, read-only transactions, batch operations, transaction rollback requests, resource contentions, and other types of operations on a complex database to provide a better representation of typical workloads.
- TPC-D
This benchmark measures query-processing power in terms of completion times for very large queries. TPC-D is a decision-support benchmark built around a set of typical business questions phrased as SQL queries against large databases (in the gigabyte or terabyte range).

Because every database application has its own particular workload, you cannot use TPC benchmarks to predict the throughput for your application. The actual throughput that you achieve depends largely on your application.

Response time

Response time measures the performance of an individual transaction or query. Response time is typically treated as the elapsed time from the moment that a user enters a command or activates a function until the time that the application indicates that the command or function has completed.

The response time for a typical Informix application includes the following sequence of actions. Each action requires a certain amount of time. The response time does not include the time that it takes for the user to think of and enter a query or request:

1. The application forwards a query to the database server.
2. The database server performs query optimization and retrieves any user-defined routines (UDRs). UDRs include both SPL routines and external routines. For more information about UDRs, see the *IBM Informix User-Defined Routines and Data Types Developer's Guide*.
3. The database server retrieves, adds, or updates the appropriate records and performs disk I/O operations directly related to the query.
4. The database server performs any background I/O operations, such as logging and page cleaning, that occur during the period in which the query or transaction is still pending.
5. The database server returns a result to the application.
6. The application displays the information or issues a confirmation and then issues a new prompt to the user.

Figure 1-1 contains a diagram that shows how the actions just described in steps 1 through 6 contribute to the overall response time.

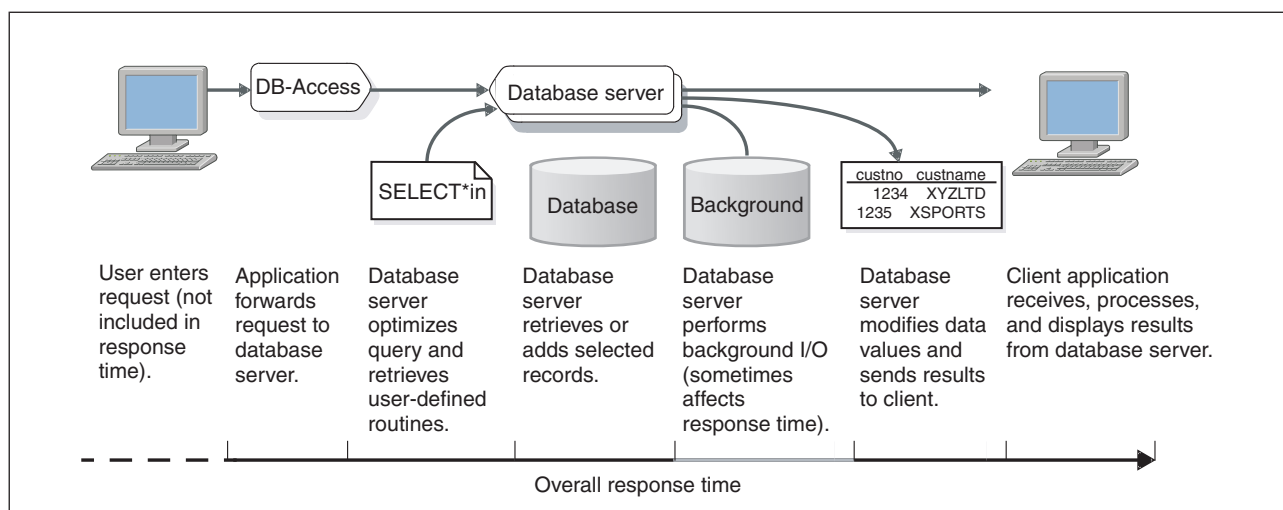

Figure 1-1. Components of the response time for a single transaction

Response time and throughput

Response time and throughput are related. The response time for an average transaction tends to decrease as you increase overall throughput.

However, you can decrease the response time for a specific query, at the expense of overall throughput, by allocating a disproportionate amount of resources to that query. Conversely, you can maintain overall throughput by restricting the resources that the database allocates to a large query.

The trade-off between throughput and response time becomes evident when you try to balance the ongoing need for high transaction throughput with an immediate need to perform a large decision-support query. The more resources that you apply to the query, the fewer you have available to process transactions, and the larger the impact your query can have on transaction throughput. Conversely, the fewer resources you allow the query, the longer the query takes.

Response-time measurement

To measure the response time for a query or application, you can use the timing commands and performance monitoring and timing functions that your operating system provides.

Operating-system timing commands:

Your operating system typically has a utility that you can use to time a command. You can often use this timing utility to measure the response times to SQL statements that a DB-Access command file issues.

UNIX Only

If you have a command file that performs a standard set of SQL statements, you can use the **time** command on many systems to obtain an accurate timing for those commands. For more information about command files, see the IBM Informix DB-Access User's Guide.

The following example shows the output of the UNIX **time** command:

```
time commands.dba
...
4.3 real          1.5 user          1.3 sys
```

The **time** output lists the amount of elapsed time (real), the user CPU time, and the system CPU time. If you use the C shell, the first three columns of output from the C shell **time** command show the user, system, and elapsed times, respectively. In general, an application often performs poorly when the proportion of system CPU time exceeds one-third of the total elapsed time.

The **time** command gathers timing information about your application. You can use this command to invoke an instance of your application, perform a database operation, and then exit to obtain timing figures, as the following example illustrates:

```
time sqlapp
  (enter SQL command through sqlapp, then exit)
10.1 real          6.4 user          3.7 sys
```

You can use a script to run the same test repeatedly, which allows you to obtain comparable results under different conditions. You can also obtain estimates of your average response time by dividing the elapsed time for the script by the number of database operations that the script performs.

Operating-system tools for monitoring performance:

Operating systems usually have a performance monitor that you can use to measure response time for a query or process.

Windows Only

You can often use the Performance Logs and Alerts that the Windows operating system supplies to measure the following times:

- User time
- Processor time
- Elapsed time

Timing functions within your application:

Most programming languages have a library function for the time of day. If you have access to the source code, you can insert pairs of calls to this function to measure the elapsed time between specific actions.

ESQL/C Only

For example, if the application is written in IBM Informix ESQL/C, you can use the **dtcurrent()** function to obtain the current time. To measure response time, you can call **dtcurrent()** to report the time at the start of a transaction and again to report the time when the transaction commits.

Elapsed time, in a multiprogramming system or network environment where resources are shared among multiple processes, does not always correspond to execution time. Most operating systems and C libraries contain functions that return the CPU time of a program.

Cost per transaction

The cost per transaction is a financial measure that is typically used to compare overall operating costs among applications, database servers, or hardware platforms.

To measure the cost per transaction:

1. Calculate all the costs associated with operating an application. These costs can include the installed price of the hardware and software; operating costs, including salaries; and other expenses. These costs can include the installed price of the hardware and software; operating costs, including salaries; and other expenses.
2. Project the total number of transactions and queries for the effective life of an application.
3. Divide the total cost over the total number of transactions.

Although this measure is useful for planning and evaluation, it is seldom relevant to the daily issues of achieving optimum performance.

Resource utilization and performance

A typical transaction-processing application undergoes different demands throughout its various operating cycles. Peak loads during the day, week, month, and year, as well as the loads imposed by decision-support (DSS) queries or backup operations, can significantly impact any system that is running near capacity. You can use direct historical data derived from your particular system to pinpoint this impact.

You must take regular measurements of the workload and performance of your system to predict peak loads and compare performance measurements at different

points in your usage cycle. Regular measurements help you to develop an overall performance profile for your database server applications. This profile is critical in determining how to improve performance reliably.

For the measurement tools that the database server provides, see “Database server tools” on page 2-3. For the tools that your operating system provides for measuring performance impacts on system and hardware resources, see “Operating-system tools” on page 2-2.

Utilization is the percentage of time that a component is actually occupied, as compared with the total time that the component is available for use. For instance, if a CPU processes transactions for a total of 40 seconds during a single minute, its utilization during that interval is 67 percent.

Measure and record utilization of the following system resources regularly:

- CPU
- Memory
- Disk

A resource is said to be *critical* to performance when it becomes overused or when its utilization is disproportionate to that of other components. For instance, you might consider a disk to be critical or overused when it has a utilization of 70 percent and all other disks on the system have 30 percent. Although 70 percent does not indicate that the disk is severely overused, you can improve performance by rearranging data to balance I/O requests across the entire set of disks.

How you measure resource utilization depends on the tools that your operating system provides for reporting system activity and resource utilization. After you identify a resource that seems overused, you can use the performance-monitoring utilities that the database server provides to gather data and make inferences about the database activities that might account for the load on that component. You can adjust your database server configuration or your operating system to reduce those database activities or spread them among other components. In some cases, you might need to provide additional hardware resources to resolve a performance bottleneck.

Resource utilization

Whenever a system resource, such as a CPU or a particular disk, is occupied by a transaction or query, the resource is unavailable for processing other requests. Pending requests must wait for the resources to become available before they can complete.

When a component is too busy to keep up with all its requests, the overused component becomes a bottleneck in the flow of activity. The higher the percentage of time that the resource is occupied, the longer each operation must wait for its turn.

You can use the following formula to estimate the service time for a request based on the overall utilization of the component that services the request. The expected service time includes the time that is spent both waiting for and using the resource in question. Think of service time as that portion of the response time accounted for by a single component within your computer, as the following formula shows:

$$S = P / (1 - U)$$

S is the expected service time.

P is the processing time that the operation requires after it obtains the resource.

U is the utilization for the resource (expressed as a decimal).

As Figure 1-2 shows, the service time for a single component increases dramatically as the utilization increases beyond 70 percent. For instance, if a transaction requires 1 second of processing by a given component, you can expect it to take 2 seconds on a component at 50 percent utilization and 5 seconds on a component at 80 percent utilization. When utilization for the resource reaches 90 percent, you can expect the transaction to take 10 seconds to make its way through that component.

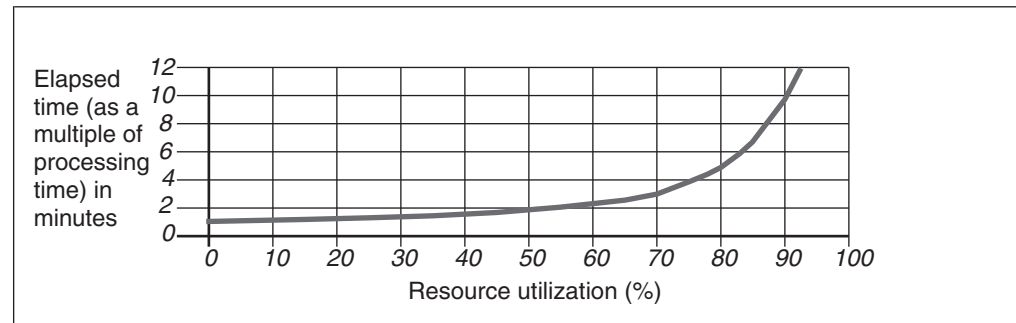

Figure 1-2. Service Time for a Single Component as a Function of Resource Utilization

If the average response time for a typical transaction soars from 2 or 3 seconds to 10 seconds or more, users are certain to notice and complain.

Important: Monitor any system resource that shows a utilization of over 70 percent or any resource that exhibits symptoms of overuse as described in the following sections.

When you consider resource utilization, also consider whether increasing the page size of a standard or temporary dbspace is beneficial in your environment. If you want a longer key length than is available for the default page size of a standard or temporary dbspace, you can increase the page size.

CPU utilization

Estimates of CPU utilization and response time can help you determine if you need to eliminate or reschedule some activities.

You can use the resource-utilization formula in the previous topic (“Resource utilization” on page 1-8) to estimate the response time for a heavily loaded CPU. However, high utilization for the CPU does not always indicate a performance problem. The CPU performs all calculations that are needed to process transactions. The more transaction-related calculations that it performs within a given period, the higher the throughput will be for that period. As long as transaction throughput is high and seems to remain proportional to CPU utilization, a high CPU utilization indicates that the computer is being used to the fullest advantage.

On the other hand, when CPU utilization is high but transaction throughput does not keep pace, the CPU is either processing transactions inefficiently or it is engaged in activity not directly related to transaction processing. CPU cycles are being diverted to internal housekeeping tasks such as memory management.

You can easily eliminate the following activities:

- Large queries that might be better scheduled at an off-peak time
- Unrelated application programs that might be better performed on another computer

If the response time for transactions increases to such an extent that delays become unacceptable, the processor might be swamped; the transaction load might be too high for the computer to manage. Slow response time can also indicate that the CPU is processing transactions inefficiently or that CPU cycles are being diverted.

When CPU utilization is high, a detailed analysis of the activities that the database server performs can reveal any sources of inefficiency that might be present due to improper configuration. For information about analyzing database server activity, see “Database server tools” on page 2-3.

Memory utilization

Memory is not managed as a single component, such as a CPU or disk, but as a collection of small components called *pages*.

The size of a typical page in memory can range from 1 to 8 kilobytes, depending on your operating system. A computer with 64 megabytes of memory and a page size of 2 kilobytes contains approximately 32,000 pages.

When the operating system needs to allocate memory for use by a process, it scavenges any unused pages within memory that it can find. If no free pages exist, the memory-management system has to choose pages that other processes are still using and that seem least likely to be needed in the short run. CPU cycles are required to select those pages. The process of locating such pages is called a *page scan*. CPU utilization increases when a page scan is required.

Memory-management systems typically use a *least recently used* algorithm to select pages that can be copied out to disk and then freed for use by other processes. When the CPU has identified pages that it can appropriate, it *pages out* the old page images by copying the old data from those pages to a dedicated disk. The disk or disk partition that stores the page images is called the *swap disk*, *swap space*, or *swap area*. This paging activity requires CPU cycles as well as I/O operations.

Eventually, page images that have been copied to the swap disk must be brought back in for use by the processes that require them. If there are still too few free pages, more must be paged out to make room. As memory comes under increasing demand and paging activity increases, this activity can reach a point at which the CPU is almost fully occupied with paging activity. A system in this condition is said to be *thrashing*. When a computer is thrashing, all useful work comes to a halt.

To prevent thrashing, some operating systems use a coarser memory-management algorithm after paging activity crosses a certain threshold. This algorithm is called *swapping*. When the memory-management system resorts to swapping, it appropriates all pages that constitute an entire process image at once, rather than a page at a time.

Swapping frees up more memory with each operation. However, as swapping continues, every process that is swapped out must be read in again, dramatically increasing disk I/O to the swap device and the time required to switch between processes. Performance is then limited to the speed at which data can be

transferred from the swap disk back into memory. Swapping is a symptom of a system that is severely overloaded, and throughput is impaired.

Many systems provide information about paging activity that includes the number of page scans performed, the number of pages sent out of memory (*paged out*), and the number of pages brought in from memory (*paged in*):

- Paging out is the critical factor because the operating system pages out only when it cannot find pages that are free already.
- A high rate of page scans provides an early indicator that memory utilization is becoming a bottleneck.
- Pages for terminated processes are freed in place and simply reused, so paging-in activity does not provide an accurate reflection of the load on memory. A high rate of paging in can result from a high rate of process turnover with no significant performance impact.

Although the principle for estimating the service time for memory is the same as that described in “Resource utilization and performance” on page 1-7, you use a different formula to estimate the performance impact of memory utilization than you do for other system components.

You can use the following formula to calculate the expected paging delay for a given CPU utilization level and paging rate:

$$PD = (C / (1 - U)) * R * T$$

PD is the paging delay.

C is the CPU service time for a transaction.

U is the CPU utilization (expressed as a decimal).

R is the paging-out rate.

T is the service time for the swap device.

As paging increases, CPU utilization also increases, and these increases are compounded. If a paging rate of 10 per second accounts for 5 percent of CPU utilization, increasing the paging rate to 20 per second might increase CPU utilization by an additional 5 percent. Further increases in paging lead to even sharper increases in CPU utilization, until the expected service time for CPU requests becomes unacceptable.

Disk utilization

Because transfer rates vary among disks, most operating systems do not report disk utilization directly. Instead, they report the number of data transfers per second (in operating-system memory-page-size units.)

Because each disk acts as a single resource, you can use the following basic formula to estimate the service time, which is described in detail in “Resource utilization” on page 1-8:

$$S = P / (1 - U)$$

To compare the load on disks with similar access times, simply compare the average number of transfers per second.

If you know the access time for a given disk, you can use the number of transfers per second that the operating system reports to calculate utilization for the disk. To do so, multiply the average number of transfers per second by the access time for

the disk as listed by the disk manufacturer. Depending on how your data is laid out on the disk, your access times can vary from the rating of the manufacturer. To account for this variability, you should add 20 percent to the access-time specification of the manufacturer.

The following example shows how to calculate the utilization for a disk with a 30-millisecond access time and an average of 10 transfer requests per second:

$$\begin{aligned} U &= (A * 1.2) * X \\ &= (.03 * 1.2) * 10 \\ &= .36 \end{aligned}$$

U is the resource utilization (this time of a disk).

A is the access time (in seconds) that the manufacturer lists.

X is the number of transfers per second that your operating system reports.

You can use the utilization to estimate the processing time at the disk for a transaction that requires a given number of disk transfers. To calculate the processing time at the disk, multiply the number of disk transfers by the average access time. Include an extra 20 percent to account for access-time variability:

$$P = D (A * 1.2)$$

P is the processing time at the disk.

D is the number of disk transfers.

A is the access time (in seconds) that the manufacturer lists.

For example, you can calculate the processing time for a transaction that requires 20 disk transfers from a 30-millisecond disk as follows:

$$\begin{aligned} P &= 20 (.03 * 1.2) \\ &= 20 * .036 \\ &= .72 \end{aligned}$$

Use the processing time and utilization values that you calculated to estimate the expected service time for I/O at the particular disk, as the following example shows:

$$\begin{aligned} S &= P / (1 - U) \\ &= .72 / (1 - .36) \\ &= .72 / .64 \\ &= 1.13 \end{aligned}$$

Factors that affect resource utilization

The performance of your database server application depends many factors, including hardware and software configuration, your network configuration, and the design of your database.

You must consider these factors when you attempt to identify performance problems or make adjustments to your system:

- Hardware resources

As discussed earlier in this chapter, hardware resources include the CPU, physical memory, and disk I/O subsystems.

- Operating-system configuration

The database server depends on the operating system to provide low-level access to devices, process scheduling, interprocess communication, and other vital services.

The configuration of your operating system has a direct impact on how well the database server performs. The operating-system kernel takes up a significant amount of physical memory that the database server or other applications cannot use. However, you must reserve adequate kernel resources for the database server to use.

- Network configuration and traffic

Applications that depend on a network for communication with the database server, and systems that rely on data replication to maintain high availability, are subject to the performance constraints of that network. Data transfers over a network are typically slower than data transfers from a disk. Network delays can have a significant impact on the performance of the database server and other application programs that run on the host computer.

- Database server configuration

Characteristics of your database server instance, such as the number of CPU virtual processors (VPs), the size of your resident and virtual shared-memory portions, and the number of users, play an important role in determining the capacity and performance of your applications.

- Dbspace, blobspace, and chunk configuration

The following factors can affect the time that it takes the database server to perform disk I/O and process transactions:

- The placement of the root dbspace, physical logs, logical logs, and temporary-table dbspaces
- The presence or absence of mirroring
- The use of devices that are buffered or unbuffered by the operation system

- Database and table placement

The placement of tables and fragments within dbspaces, the isolation of high-use fragments in separate dbspaces, and the spreading of fragments across multiple dbspaces can affect the speed at which the database server can locate data pages and transfer them to memory.

- Tblspace organization and extent sizing

Fragmentation strategy and the size and placement of extents can affect the ability of the database server to scan a table rapidly for data. Avoid interleaved extents and allocate extents that are sufficient to accommodate growth of a table to prevent performance problems.

- Query efficiency

Proper query construction and cursor use can decrease the load that any one application or user imposes. Remind users and application developers that others require access to the database and that each person's activities affect the resources that are available to others.

- Scheduling background I/O activities

Logging, checkpoints, page cleaning, and other operations, such as making backups or running large decision-support queries, can impose constant overhead and large temporary loads on the system. Schedule backup and batch operations for off-peak times whenever possible.

- Remote client/server operations and distributed join operations

These operations have an important impact on performance, especially on a host system that coordinates distributed joins.

- Application-code efficiency

Application programs introduce their own load on the operating system, the network, and the database server. These programs can introduce performance problems if they make poor use of system resources, generate undue network

traffic, or create unnecessary contention in the database server. Application developers must make proper use of cursors and locking levels to ensure good database server performance.

Maintenance of good performance

Performance is affected in some way by all system users: the database server administrator, the database administrator, the application designers, and the client application users.

The database server administrator usually coordinates the activities of all users to ensure that system performance meets overall expectations. For example, the operating-system administrator might need to reconfigure the operating system to increase the amount of shared memory. Bringing down the operating system to install the new configuration requires bringing the database server down. The database server administrator must schedule this downtime and notify all affected users when the system will be unavailable.

The database server administrator should:

- Be aware of all performance-related activities that occur.
- Educate users about the importance of performance, how performance-related activities affect them, and how they can assist in achieving and maintaining optimal performance.

The database administrator should pay attention to:

- How tables and queries affect the overall performance of the database server
- The placement of tables and fragments
- How the distribution of data across disks affects performance

Application developers should:

- Carefully design applications to use the concurrency and sorting facilities that the database server provides, rather than attempt to implement similar facilities in the application.
- Keep the scope and duration of locks to the minimum to avoid contention for database resources.
- Include routines within applications that, when temporarily enabled at runtime, allow the database server administrator to monitor response times and transaction throughput.

Database users should:

- Pay attention to performance and report problems to the database server administrator promptly.
- Be courteous when they schedule large, decision-support queries and request as few resources as possible to get the work done.

Chapter 2. Performance monitoring and the tools you use

You can use performance monitoring tools to create a performance history, to monitor database resources at scheduled times, or to monitor ongoing transaction or query performance.

This chapter also contains cross-references to topics that about how to interpret the results of performance monitoring

The kinds of data that you need to collect depend on the kinds of applications that you run on your system. The causes of performance problems on OLTP (online transaction processing) systems are different from the causes of problems on systems that are used primarily for DSS query applications. Systems with mixed use provide a greater performance-tuning challenge and require a sophisticated analysis of performance-problem causes.

Evaluate the current configuration

Before you begin to adjust the configuration of your database server, evaluate the performance of your current configuration.

To alter certain database server characteristics, you must bring down the database server, which can affect your production system. Some configuration adjustments can unintentionally decrease performance or cause other negative side effects.

If your database applications perform well enough to satisfy user expectations, you should avoid frequent adjustments, even if those adjustments might theoretically improve performance. As long as your users are reasonably satisfied, take a measured approach to reconfiguring the database server. When possible, use a test instance of the database server to evaluate configuration changes before you reconfigure your production system.

To examine your current database server configuration, you can use the utilities described in this chapter.

When performance problems relate to backup operations, you might also examine the number or transfer rates for tape drives. You might need to alter the layout or fragmentation of your tables to reduce the impact of backup operations. For information about disk layout and table fragmentation, see Chapter 6, "Table performance considerations," on page 6-1 and Chapter 7, "Indexes and index performance considerations," on page 7-1.

For client/server configurations, consider network performance and availability. Evaluating network performance is beyond the scope of this publication. For information about monitoring network activity and improving network availability, see your network administrator or see the documentation for your networking package.

Create a performance history

As soon as you set up your database server and begin to run applications on it, you should begin scheduled monitoring of resource use. As you accumulate data, you can analyze performance information.

To accumulate data for performance analysis, use the command-line utilities described in “Database server tools” on page 2-3 and “Operating-system tools” in operating scripts or batch files.

The importance of a performance history

If you have a history of the performance of your system, you can begin to track the cause of problems as soon as users report slow response or inadequate throughput.

If a history is not available, you must start tracking performance after a problem arises, and you might not be able to tell when and how the problem began. Trying to identify problems after the fact significantly delays resolution of a performance problem.

To build a performance history and profile of your system, take regular snapshots of resource-utilization information.

For example, if you chart the CPU utilization, paging-out rate, and the I/O transfer rates for the various disks on your system, you can begin to identify peak-use levels, peak-use intervals, and heavily loaded resources.

If you monitor fragment use, you can determine whether your fragmentation scheme is correctly configured. Monitor other resource use as appropriate for your database server configuration and the applications that run on it.

Choose tools from those described in the following sections, and create jobs that build up a history of disk, memory, I/O, and other database server resource use. To help you decide which tools to use to create a performance history, this chapter briefly describes the output of each tool.

Tools that create a performance history

When you monitor database server performance, you use tools from the host operating system and command-line utilities that you can run at regular intervals from scripts or batch files.

You also use performance monitoring tools with a graphical interface to monitor critical aspects of performance as queries and transactions are performed.

Operating-system tools

The database server relies on the operating system of the host computer to provide access to system resources such as the CPU, memory, and various unbuffered disk I/O interfaces and files. Each operating system has its own set of utilities for reporting how system resources are used.

Different implementations of some operating systems have monitoring utilities with the same name but different options and informational displays.

UNIX Only

The following table lists some UNIX utilities that monitor system resources.

UNIX Utility	Description
<code>vmstat</code>	Displays virtual-memory statistics
<code>iostat</code>	Displays I/O utilization statistics

UNIX Utility	Description
sar	Displays a variety of resource statistics
ps	Displays active process information

For details on how to monitor your operating-system resources, consult the reference manual or your system administration guide.

To capture the status of system resources at regular intervals, use scheduling tools that are available with your host operating system (for example, **cron**) as part of your performance monitoring system.

Windows Only

You can often use the Performance Logs and Alerts that the Windows operating system supplies to monitor resources such as processor, memory, cache, threads, and processes. The Performance Logs and Alerts also provide charts, alerts, reports, and the ability to save information to log files for later analysis.

For more information about how to use the Performance Logs and Alerts, consult your operating-system manuals.

Database server tools

The database server provides tools and utilities that capture snapshot information about your configuration and performance.

You can use these utilities regularly to build a historical profile of database activity, which you can compare with current operating-system resource-utilization data. These comparisons can help you discover which database server activities have the greatest impact on system-resource utilization. You can use this information to identify and manage your high-impact activities or adjust your database server or operating-system configuration.

The database server tools and utilities that you can use for performance monitoring include:

- IBM OpenAdmin Tool (OAT) for Informix
- The **onstat** utility
- The **onlog** utility
- The **oncheck** utility
- The ON-Monitor utility (on UNIX only)
- The **onperf** utility (on UNIX only)
- DB-Access and the system-monitoring interface (SMI), which you can use to monitor performance from within your application
- IBM Informix Server Administrator (ISA)

You can use **onstat**, **onlog**, or **oncheck** commands invoked by the **cron** scheduling facility to capture performance-related information at regular intervals and build a historical performance profile of your database server application. The following sections describe these utilities.

You can use SQL SELECT statements to query the system-monitoring interface (SMI) from within your application.

The SMI tables are a collection of tables and pseudo-tables in the **sysmaster** database that contain dynamically updated information about the operation of the database server. The database server constructs these tables in memory but does not record them on disk. The **onstat** utility options obtain information from these SMI tables.

You can use **cron** and SQL scripts with DB-Access or **onstat** utility options to query SMI tables at regular intervals.

Tip: The SMI tables are different from the system catalog tables. System catalog tables contain permanently stored and updated information about each database and its tables (sometimes referred to as *metadata* or a *data dictionary*).

You can use ON-Monitor to check the current database server configuration.

You can use **onperf** to display database server activity with the Motif window manager.

Related concepts

 DB-Access User's Guide (DB-Access Guide)

 System catalog tables (SQL Reference)

Chapter 14, "The onperf utility on UNIX," on page 14-1

Related reference

 The System-Monitoring Interface Tables (Administrator's Reference)

 Using ON-Monitor (UNIX) (Administrator's Reference)

Performance information that IBM OpenAdmin Tool (OAT) for Informix provides:

The IBM OpenAdmin Tool (OAT) for Informix provides multiple ways to gather, view, and analyze performance data.

With OAT, you can:

- Collect performance statistics.
- Find and eliminate database server performance bottlenecks.
- Identify and monitor queries that are critical to performance.
- Improve checkpoint performance and manage LRU queues.
- Manage compression of data in tables and table-fragment rows
- Monitor critical system resources (CPU, memory, disk, virtual processors).
- Monitor and track locking.
- Optimize the disk layout.
- Tune the buffer cache.
- Use query drill down.
- View the SQL statement cache.
- Use automatic statistics update.
- View historical performance graphs.
- Explore user sessions.

OAT is an open-source program that you can download from this Web site:
[https://www14.software.ibm.com/webapp/iwm/web/preLogin.do?lang=en_US
&source=swg-informixfpd](https://www14.software.ibm.com/webapp/iwm/web/preLogin.do?lang=en_US&source=swg-informixfpd)

Performance information that IBM Informix Server Administrator provides:

IBM Informix Server Administrator (ISA) is a browser-based tool that provides Web-based system administration for the entire range of IBM Informix database servers.

ISA is the first in a new generation of browser-based, cross-platform administrative tools. It provides access to every Informix database server command-line function and presents the output in an easy-to-read format.

The database server CD-ROM distributed with your product includes ISA. For information on how to install ISA, see the following file on the CD-ROM.

Table 2-1. Operating system file

Operating System	File
UNIX	/SVR_ADM/README
Windows	\SVR_ADM\readme.txt

With ISA, you can use a browser to perform these common database server administrative tasks:

- Change configuration parameters temporarily or permanently
- Change the database server mode between online and offline and its intermediate states
- Modify connectivity information in the **sqlhosts** file
- Check dbspaces, sbspaces, logs, and other objects
- Manage logical and physical logs
- Examine memory use and adding and freeing memory segments
- Read the message log
- Back up and restore dbspaces and sbspaces
- Run various **onstat** commands to monitor performance
- Enter simple SQL statements and examine database schemas
- Add and remove chunks, dbspaces, and sbspaces
- Examine and manage user sessions
- Examine and manage virtual processors (VPs)
- Use the High-Performance Loader (HPL), **dbimport**, and **dbexport**
- Manage Enterprise Replication
- Manage an IBM Informix MaxConnect server
- Use the following utilities: **dbaccess**, **dbschema**, **onbar**, **oncheck**, **ondblog**, **oninit**, **onlog**, **onmode**, **onparams**, **onspaces**, and **onstat**

You also can enter any Informix utility, UNIX shell command, or Windows command (for example, **oncheck -cd; ls -l**).

Performance information that the **onstat** utility displays:

The **onstat** utility displays a wide variety of performance-related and status information contained within the SMI tables. You can use the **onstat** utility to check the current status of the database server and monitor the activities of the database server.

For a complete list of all **onstat** options, use the **onstat - -** command. For a complete display of all the information that **onstat** gathers, use the **onstat -a** command.

Tip: Profile information displayed by **onstat** commands, such as **onstat -p**, accumulates from the time the database server was started. To clear performance profile statistics so that you can create a new profile, run the **onstat -z**. If you use **onstat -z** to reset statistics for a performance history or appraisal, ensure that other users do not also enter the command at different intervals.

The following table lists some of the **onstat** commands that display general performance-related information.

Table 2-2. onstat commands that display performance information

onstat command	Description
onstat -p	Displays a performance profile that includes the number of reads and writes, the number of times that a resource was requested but was not available, and other miscellaneous information
onstat -b	Displays information about buffers currently in use
onstat -l	Displays information about the physical and logical logs
onstat -x	Displays information about transactions, including the thread identifier of the user who owns the transaction
onstat -u	Displays a user activity profile that provides information about user threads including the thread owner's session ID and login name
onstat -R	Displays information about buffer pools, including information about buffer pool page size.
onstat -F	Displays page-cleaning statistics that include the number of writes of each type that flushes pages to disk
onstat -g	Requires an additional argument that specifies the information to be displayed For example, onstat -g mem displays memory statistics.

For more information about options that provide performance-related information, see “Monitoring fragmentation with the **onstat -g ppf** command” on page 9-27 and “Monitor database server resources.”

Related reference

 [onstat -g monitoring options \(Administrator's Reference\)](#)

Monitor database server resources

Monitor specific database server resources to identify performance bottlenecks and potential trouble spots and to improve resource use and response time.

One of the most useful commands for monitoring system resources is **onstat -g** and its many options. ISA executes **onstat** options to display information. “Monitoring fragment use” on page 9-27 and “Monitoring and tuning the SQL statement cache” on page 4-32 contain many **onstat -g** examples.

Monitor resources that impact CPU utilization

Threads, network communications, and virtual processors impact CPU utilization. You can use **onstat -g** arguments to monitor threads, network communications, and virtual processors.

Use the following **onstat -g** command options to monitor threads.

onstat -g Option	Description
act	Displays active threads.
ath	Displays all threads. The sqlxec threads represent portions of client sessions; the rstcb value corresponds to the user field of the onstat -u command.
cpu	Displays the last time the thread ran, how much CPU time the thread used, the number of times the thread ran, and other statistics about all the threads running in the server.
rea	Displays ready threads.
sle	Displays all sleeping threads.
sts	Displays maximum and current stack use per thread.
tpf <i>tid</i>	Displays a thread profile for <i>tid</i> . If <i>tid</i> is 0, this argument displays profiles for all threads.
wai	Displays waiting threads, including all threads waiting on mutex or condition, or yielding.

Use the following **onstat -g** command options to monitor the network.

onstat -g Command Option	Description
ntd	Displays network statistics by service.
ntt	Displays network user times.
ntu	Displays network user statistics.
qst	Displays queue statistics.

Use the following **onstat -g** command options to monitor virtual processors.

onstat -g Command Option	Description
glo	Displays global multithreading information, including CPU-use information about virtual processors, the total number of sessions, and other multithreading global counters.

onstat -g Command Option	Description
sch	Displays the number of semaphore operations, spins, and busy waits for each VP.
spi	Displays longspins, which are spin locks acquired by virtual processors after they have spun more than 10,000 times. To reduce longspins, reduce the number of virtual processors, reduce the load on the computer, or, on some platforms, use the <i>no-age</i> or <i>processor affinity</i> features.
wst	Displays wait statistics.

Monitor memory utilization

You can use some specific **onstat -g** command options to monitor memory utilization.

Use the following **onstat -g** options to monitor memory utilization. For overall memory information, omit *table name*, *pool name*, or *session id* from the commands that permit those optional parameters.

Table 2-3. onstat -g Options for monitoring memory utilization

Argument	Description
ffr <i>pool name</i> <i>session id</i>	Displays free fragments for a pool of shared memory or by session
dic <i>table name</i>	Displays one line of information for each table cached in the shared-memory dictionary If you provide a specific table name as a parameter, this argument displays internal SQL information about that table.
dsc	Displays one line of information for each column of distribution statistics cached in the data distribution cache.
mem <i>pool name</i> <i>session id</i>	Displays memory statistics for the pools that are associated with a session If you omit <i>pool_name</i> <i>session id</i> , this argument displays pool information for all sessions.

Table 2-3. **onstat -g** Options for monitoring memory utilization (continued)

Argument	Description
mgm	<p>Displays Memory Grant Manager resource information, including:</p> <ul style="list-style-type: none"> • The values of the PDQ configuration parameters • Memory and scan information • Load information, such as the number of queries that are waiting for memory, the number of queries that are waiting for scans, the number of queries that are waiting for queries with higher PDQ priority to run, and the number of queries that are waiting for a query slot • Active queries and the number of queries at each gate • Statistics on free resources • Statistics on queries • The resource/lock cycle prevention count, which shows the number of times the system immediately activated a query to avoid a potential deadlock
nsc <i>client id</i>	<p>Displays shared-memory status by client ID</p> <p>If you omit <i>client id</i>, this argument displays all client status areas.</p>
nsd	<p>Displays network shared-memory data for poll threads</p>
nss <i>session id</i>	<p>Displays network shared-memory status by session id</p> <p>If you omit <i>session id</i>, this argument displays all session status areas.</p>
osi	<p>Displays information about your operating system resources and parameters, including shared memory and semaphore parameters, the amount of memory currently configured on the computer, and the amount of memory that is unused</p> <p>Use this option when the server is not online.</p>
prc	<p>Displays one line of information for each user-defined routine (SPL routine or external routine written in C or Java programming language) cached in the UDR cache</p>
seg	<p>Displays shared-memory-segment statistics</p> <p>This argument shows the number and size of all attached segments.</p>
ses <i>session id</i>	<p>Displays memory usage for session id</p> <p>If you omit <i>session id</i>, this argument displays memory usage for all sessions.</p>
ssc	<p>Displays one line of information for each query cached in the SQL statement cache</p>

Table 2-3. **onstat -g** Options for monitoring memory utilization (continued)

Argument	Description
stm <i>session id</i>	Displays memory usage of each SQL statement for session id If you omit session id, this argument displays memory usage for all sessions.
ufr <i>pool name</i> <i>session id</i>	Displays allocated pool fragments by user or session

Related reference

 [onstat -g monitoring options \(Administrator's Reference\)](#)

Monitor disk I/O utilization

You can use some specific **onstat -g** arguments, ISA, and the **oncheck** utility to determine if your disk I/O operations are efficient for your applications.

Using onstat -g to monitor I/O utilization

You can use some specific **onstat -g** command arguments to monitor disk IO.

Use the following **onstat -g** command arguments to monitor disk I/O utilization.

onstat -g Argument	Description
iof	Displays asynchronous I/O statistics by chunk or file This argument is similar to the onstat -d , except that information about nonchunk files also appears. This argument displays information about temporary dbspaces and sort files.
iog	Displays asynchronous I/O global information
ioq	Displays asynchronous I/O queuing statistics
iov	Displays asynchronous I/O statistics by virtual processor

For a detailed case study that uses various **onstat** outputs, see Appendix A, “Case studies and examples,” on page A-1.

Using ISA to monitor I/O utilization

You can use ISA to monitor disk I/O utilization.

ISA uses information that the following **onstat** command-line options generate to display session information, as the following table shows.

To monitor	Select on ISA	Displays onstat output
Asynchronous I/O statistics by chunk or file	Performance > AIO > Disk I/O by Queue	onstat -g iof
Asynchronous I/O global information	Performance > AIO > Global Information	onstat -g iog

To monitor	Select on ISA	Displays onstat output
Asynchronous I/O statistics by virtual processor	Performance > AIO > Disk I/O by VP	onstat -g iov
Asynchronous I/O queuing statistics	Performance > AIO > Disk I/O by File	onstat -g ioq

Using the oncheck utility to monitor I/O utilization

Disk I/O operations are usually the longest component of the response time for a query. You can use the **oncheck** Utility to monitor disk I/O operations.

Contiguously allocated disk space improves sequential disk I/O operations, because the database server can read in larger blocks of data and use the read-ahead feature to reduce the number of I/O operations.

The **oncheck** utility displays information about storage structures on a disk, including chunks, dbspaces, blobspaces, extents, data rows, system catalog tables, and other options. You can also use **oncheck** to determine the number of extents that exist within a table and whether or not a table occupies contiguous space.

The **oncheck** utility provides the following options and information that apply to contiguous space and extents. For information about how to use other **oncheck** options, see the *IBM Informix Administrator's Guide*.

Option	Information
-pB	Blobspace simple large object (TEXT or BYTE data) For information about how to use this option to determine the efficiency of blobpage size, see "Determine blobpage fullness with oncheck -pB output" on page 5-17.
-pe	Chunks and extents For information about how to use this option to monitor extents, see "Checking for extent interleaving" on page 6-25 and "Eliminating interleaved extents" on page 6-25.
-pk	Index key values. For information about how to improve the performance of this option, see "Improving performance for index checks" on page 7-15.
-pK	Index keys and row IDs For information about how to improve the performance of this option, see "Improving performance for index checks" on page 7-15.
-pl	Index-leaf key values For information about how to improve the performance of this option, see "Improving performance for index checks" on page 7-15.
-pL	Index-leaf key values and row IDs For information about how to improve the performance of this option, see "Improving performance for index checks" on page 7-15.
-pp	Pages by table or fragment For information about how to use this option to monitor space, see "Considering the upper limit on extents" on page 6-23.

Option	Information
-pP	Pages by chunk For information about how to use this option to monitor extents, see “Considering the upper limit on extents” on page 6-23.
-pr	Root reserved pages For information about how to use this option, see “Estimating tables with fixed-length rows” on page 6-5.
-ps	Space used by smart large objects and metadata in sbspace.
-pS	Space used by smart large objects and metadata in sbspace and storage characteristics For information about how to use this option to monitor space, see “Monitoring sbspaces” on page 6-13.
-pt	Space used by table or fragment For information about how to use this option to monitor space, see “Estimating table size” on page 6-5.
-pT	Space used by table, including indexes For information about how to use this option to monitor space, see “Performance considerations for DDL statements” on page 6-37.

For more information about using **oncheck** to monitor space, see “Estimating table size” on page 6-5. For more information about concurrency during **oncheck** execution, see “Improving performance for index checks” on page 7-15.

Related concepts

 [The oncheck Utility \(Administrator's Reference\)](#)

Monitor transactions

You can use the **onlog** and **onstat** utilities and ISA to monitor transactions.

Using the onlog utility to monitor transactions

The **onlog** utility displays all or selected portions of the logical log. This utility can help you identify a problematic transaction or gauge transaction activity that corresponds to a period of high utilization, as indicated by your periodic snapshots of database activity and system-resource consumption.

This **onlog** utility can take input from selected log files, the entire logical log, or a backup tape of previous log files.

Use **onlog** with caution when you read logical-log files still on disk, because attempting to read unreleased log files stops other database activity. For greatest safety, back up the logical-log files first and then read the contents of the backup files. With proper care, you can use the **onlog -n** option to restrict **onlog** only to logical-log files that have been released.

To check on the status of logical-log files, use **onstat -l**.

Related concepts

 [The onlog Utility \(Administrator's Reference\)](#)

Using the onstat utility to monitor transactions

If the throughput of transactions is not very high, you can use some **onstat** utility commands to identify a transaction that might be a bottleneck.

Use the following **onstat** utility commands to monitor transactions.

onstat command	Description
onstat -x	Displays transaction information such as number of locks held and isolation level.
onstat -u	Displays information about each user thread
onstat -k	Displays locks held by each session
onstat -g sql	Displays last SQL statement this session executed

Related reference

 [The onstat utility \(Administrator's Reference\)](#)

Using ISA to monitor transactions

You can use ISA to monitor transactions, the locks that open transactions hold, and user sessions.

ISA uses information that the following **onstat** command-line options generate to display session information, as the following table shows. Click the **Refresh** button to rerun the **onstat** command and display fresh information.

To monitor	Select on ISA	Displays onstat output	See
Transaction statistics, such as number of locks held and isolation level	Users > Transaction	onstat -x	"Display information about transactions" on page 13-53
User session statistics	Users > Threads	onstat -u	"Display statistics on user sessions" on page 13-55
Lock statistics	Performance > Locks	onstat -k	"Display information about transaction locks" on page 13-54
Sessions running SQL statements	Users > Connections > session-id	onstat -g sql <i>sessid</i>	"Display statistics on sessions executing SQL statements" on page 13-56

Monitor sessions and queries

Monitoring sessions and threads is important for sessions that perform queries as well as sessions that perform inserts, updates, and deletes. Some of the information that you can monitor for sessions and threads allows you to determine if an application is using a disproportionate amount of the resources.

To monitor database server activity, you can view the number of active sessions and the amount of resources that they are using.

Monitoring memory usage for each session

You can use some specific **onstat -g** command arguments to get memory information for each session.

Use the following command arguments to get memory information for each session.

onstat -g command argument	Description
ses	Displays one-line summaries of all active sessions
ses <i>session id</i>	Displays session information by <i>session id</i>
sql <i>session id</i>	Displays SQL information by session If you omit <i>session id</i> , this argument displays summaries of all sessions.
stm <i>session id</i>	Displays amount of memory used by each prepared SQL statement in a session If you omit <i>session id</i> , this argument displays information for all prepared statements.

For examples and discussions of session-monitoring command-line utilities, see “Monitoring memory usage for each session” on page 13-42 and “Monitor sessions and threads” on page 13-46.

Using the SET EXPLAIN statement

You can use the SET EXPLAIN statement or the EXPLAIN directive to display the query plan that the optimizer creates for an individual query.

For more information, see “Display the query plan” on page 13-1.

Chapter 3. Effect of configuration on CPU utilization

The combination of operating-system and Informix configuration parameters can affect CPU utilization. You can change the settings of the Informix configuration parameters that directly affect CPU utilization, and you can adjust the settings for different types of workloads.

Multiple database server instances that run on the same host computer perform poorly when compared with a single database server instance that manages multiple databases. Multiple database server instances cannot balance their loads as effectively as a single database server. Avoid multiple residency for production environments in which performance is critical.

UNIX configuration parameters that affect CPU utilization

Your database server distribution includes a machine notes file that contains recommended values for UNIX configuration parameters. Because the UNIX parameters affect CPU utilization, you should compare the values in the machine notes file with your current operating-system configuration.

For information about where to find this machine notes file, see the Introduction to this guide.

The following UNIX parameters affect CPU utilization:

- Semaphore parameters
- Parameters that set the maximum number of open file descriptors
- Memory configuration parameters

UNIX semaphore parameters

Semaphores are kernel resources with a typical size of 1 byte each. Semaphores for the database server are in addition to any that you allocate for other software packages.

Each instance of the database server requires the following semaphore sets:

- One set for each group of up to 100 virtual processors (VPs) that are started with the database server
- One set for each additional VP that you might add dynamically while the database server is running
- One set for each group of 100 or fewer user sessions connected through the shared-memory communication interface

Tip: For best performance, you should allocate enough semaphores for double the number of `ipcshm` connections that you expect. Use the `NETTYPE` configuration parameter to configure database server poll threads for this doubled number of connections.

Because utilities such as `onmode` use shared-memory connections, you must configure a minimum of two semaphore sets for each instance of the database server: one for the initial set of VPs and one for the shared-memory connections that database server utilities use. The `SEMMNI` operating-system configuration

parameter typically specifies the number of semaphore sets to allocate. For information about how to set semaphore-related parameters, see the configuration instructions for your operating system.

The SEMMSL operating-system configuration parameter typically specifies the maximum number of semaphores per set. Set this parameter to at least 100.

Some operating systems require that you configure a maximum total number of semaphores across all sets, which the SEMMNS operating-system configuration parameter typically specifies. Use the following formula to calculate the total number of semaphores that each instance of the database server requires:

$$\text{SEMMNS} = \text{init_vps} + \text{added_vps} + (2 * \text{shmem_users}) + \text{concurrent_utils}$$

init_vps

is the number of VPs that are started with the database server. This number includes CPU, PIO, LIO, AIO, SHM, TLI, SOC, and ADM VPs. (For a description of these VPs, see your *IBM Informix Administrator's Guide*.) The minimum value is 15.

added_vps

is the number of VPs that you intend to add dynamically.

shmem_users

is the number of shared-memory connections that you allow for this instance of the database server.

concurrent_utils

is the number of concurrent database server utilities that can connect to this instance. It is suggested that you allow for a minimum of six utility connections: two for ON-Archive or ON-Bar and four for other utilities such as ON-Monitor (UNIX only), **onstat**, and **oncheck**.

If you use software packages that require semaphores in addition to those that the database server needs, the SEMMNI configuration parameter must include the total number of semaphore sets that the database server and your other software packages require. You must set the SEMMSL configuration parameter to the largest number of semaphores per set that any of your software packages require. For systems that require the SEMMNS configuration parameter, multiply SEMMNI by the value of SEMMSL to calculate an acceptable value.

Related concepts

“Configuring poll threads” on page 3-13

UNIX file-descriptor parameters

Some operating systems require you to specify a limit on the number of file descriptors that a process can have open at any one time. To specify this limit, use an operating-system configuration parameter, typically NOFILE, NOFILES, NFILE, or NFILES.

The number of open file descriptors that each instance of the database server needs depends on the number of chunks in your database, the number of VPs that you run, and the number of network connections that your database server instance must support.

Use the following formula to calculate the number of file descriptors that your instance of the database server requires:

$$\text{NFILES} = (\text{chunks} * \text{NUMAIOVPS}) + \text{NUMBER_of_CPU_VPS} + \text{net_connections}$$

chunks is the number of chunks to be configured.

net_connections

is the number of network connections that you specify in either of the following places:

- **sqlhosts** file or registry
- NETTYPE configuration entries

Network connections include all but those specified as the **ipcshm** connection type.

Each open file descriptor is about the same length as an integer within the kernel. Allocating extra file descriptors is an inexpensive way to allow for growth in the number of chunks or connections on your system.

UNIX memory configuration parameters

The configuration of memory in the operating system can affect other resources, including CPU and I/O.

Insufficient physical memory for the overall system load can lead to thrashing, as “Memory utilization” on page 1-10 describes. Insufficient memory for the database server can result in excessive buffer-management activity. For more information about configuring memory, see “Configuring UNIX shared memory” on page 4-6.

Windows configuration parameters that affect CPU utilization

The Informix distribution includes a release notes file that contains recommended values for Informix configuration parameters on Windows. Compare the values in this file with your current ONCONFIG configuration file settings.

For the path name of the release notes file, see the Introduction to this guide.

Informix runs in the background. For best performance, give the same priority to foreground and background applications.

On Windows, to change the priorities of foreground and background applications, go to **Start > Settings > Control Panel**, open the **System** icon, and click the **Advanced Tab**. Select the **Performance Options** button and select either the **Applications** or **Background Services** radio button.

The configuration of memory in the operating system can impact other resources, including CPU and I/O. Insufficient physical memory for the overall system load can lead to thrashing, as “Memory utilization” on page 1-10 describes. Insufficient memory for Informix can result in excessive buffer-management activity. When you set the **Virtual Memory** values in the **System** icon on the **Control Panel**, ensure that you have enough paging space for the total amount of physical memory.

Configuration parameters and environment variables that affect CPU utilization

Some configuration parameters and environment variables affect CPU utilization. You might need to adjust the settings of these parameters and variables when you consider methods of improving performance.

The following configuration parameters in the database server configuration file have a significant impact on CPU utilization:

- DS_MAX_QUERIES
- DS_MAX_SCANS
- FASTPOLL
- MAX_PDQPRIORITY
- MULTIPROCESSOR
- NETTYPE
- OPTCOMPIND
- SINGLE_CPU_VP
- VPCLASS
- VP_MEMORY_CACHE_KB

The following environment variables affect CPU utilization:

- **OPTCOMPIND**
- **PDQPRIORITY**
- **PSORT_NPROCS**

The **OPTCOMPIND** environment variable, when set in the environment of a client application, indicates the preferred way to perform join operations. This variable overrides the value that the OPTCOMPIND configuration parameter sets. For details on how to select a preferred join method, see “Optimizing access methods” on page 3-10.

The **PDQPRIORITY** environment variable, when set in the environment of a client application, places a limit on the percentage of CPU VP utilization, shared memory, and other resources that can be allocated to any query that the client starts.

A client can also use the SET PDQPRIORITY statement in SQL to set a value for PDQ priority. The actual percentage allocated to any query is subject to the factor that the MAX_PDQPRIORITY configuration parameter sets. For more information about how to limit resources that can be allocated to a query, see “Limiting PDQ resources in queries” on page 3-11.

PSORT_NPROCS, when set in the environment of a client application, indicates the number of parallel sort threads that the application can use. The database server imposes an upper limit of 10 sort threads per query for any application. For more information about parallel sorts and **PSORT_NPROCS**, see “Configure dbspaces for temporary tables and sort files” on page 5-8.

Related concepts

 Environment variables (SQL Reference)

Related reference

 Configuration Parameters (Administrator's Reference)

Specifying virtual processor class information

Use the VPCLASS configuration parameter to specify a class of virtual processors, the number of virtual processors that the database server should start for a specific class, and the maximum number allowed.

To execute user-defined routines (UDRs), you can define a new class of virtual processors to isolate UDR execution from other transactions that execute on the CPU virtual processors. Typically you write user-defined routines to support user-defined data types.

If you do not want a user-defined routine to affect the normal processing of user queries in the CPU class, you can use the CREATE FUNCTION statement to assign the routine to a user-defined class of virtual processors. The class name that you specify in the VPCLASS configuration parameter must match the name specified in the CLASS modifier of the CREATE FUNCTION statement.

For guidelines, on using the **cpu** and **num** options of the VPCLASS configuration parameter, see “Setting the number of CPU VPs.”

Related reference

- [VPCLASS configuration parameter \(Administrator's Reference\)](#)
- [CREATE FUNCTION statement \(SQL Syntax\)](#)

Setting the number of CPU VPs

You can configure the number of CPU virtual processors (VPs) that the database server uses. Do not allocate more CPU VPs than there are CPU processors available to service them.

Use the following guidelines to set the number of CPU VPs:

- For uniprocessor computers, you should use one CPU VP.
`VPCLASS cpu,num=1`
- For multiprocessor systems with four or more CPUs that are primarily used as database servers, you should set the **num** option of the VPCLASS configuration parameter in the `onconfig` file to one less than the total number of processors. For example, if you have four CPUs, use the following specification:

```
VPCLASS cpu,num=3
```

When you use this setting, one processor is available to run the database server utilities or the client application.

- For multiprocessor systems that you do not use primarily to support database servers, you can start with somewhat fewer CPU VPs to allow for other activities on the system and then gradually add more if necessary.
- For multiprocessor systems that use multicore processors or hardware multithreading to support more logical CPUs than physical processors, you can assign the number of CPU VPs according to the number of logical CPU VPs available for that purpose. When you do this, remember that the amount of processing that an additional logical CPU can provide might be only a fraction of what a dedicated physical processor can support.

On systems, where multicore processors are installed, the optimal configuration of in most cases will not differ from the configuration considered for systems with a number of individual processors equal to the total number of cores. Setting the number of CPU VPs to $N-1$, where N is number of cores should be close to optimal for CPU-intensive workloads.

On machines where the CPU uses multiple threads per core, operating systems will show more logical processors than actual processing cores. To take advantage of additional CPU threads, the database server must be configured with the number of CPU VPs in the range between N and M , where N is number of cores and M is total number of logical CPUs reported by system. The number of CPU VPs where optimal performance is achieved will depend on the workload.

When increasing the number of CPU VPs to use more threads per core, the expected gain in performance will be only a fraction of what dedicated physical processor or core could provide.

If you are migrating Informix from multi-CPU/multicore systems to systems with multiple threads per core, take special care in regard to processor affinity. When binding Informix CPU VPs to the logical processors of the operating system, you must be aware of the architecture for the CPU. If you are not sure, the CPU affinity in the Informix configuration should be disabled to allow the operating system to schedule CPU VPs to logical processors with available resources. Using affinity without understanding the relationship between the logical CPUs and processing cores can result in severe performance degradation.

For example, to bind each of 8 configured CPU VPs to a separate core on an 8-core system with 2 threads per core (16 logical CPUs), use the following syntax:

```
VPCLASS cpu,num=8,aff=(0-14/2)
```

For dual-processor systems, you might improve performance by running with two CPU VPs. To test if performance improves, set the **num** option of the VPCLASS configuration parameter to 1 in the `onconfig` file and then add a CPU VP dynamically at runtime with **onmode -p**.

Related reference

 [VPCLASS configuration parameter \(Administrator's Reference\)](#)

Disabling process priority aging for CPU VPs

Use the **noage** option of the VPCLASS configuration parameter to disable process priority aging for database server CPU VPs on operating systems that support this feature. Priority aging occurs when the operating system lowers the priority of long-running processes as they accumulate processing time. You might want to disable priority aging because it can cause the performance of the database server processes to decline over time.

Your database server distribution includes a machine notes file that contains information about whether your version of the database server supports this feature. For information about where to find this machine notes file, see the Introduction to this guide.

Specify the **noage** option of VPCLASS if your operating system supports this feature.

Related reference

 [VPCLASS configuration parameter \(Administrator's Reference\)](#)

Specifying processor affinity

Use the **aff** option of the VPCLASS parameter to specify the processors to which you want to bind CPU VPs or AIO VPs. When you assign a CPU VP to a specific CPU, the VP runs only on that CPU. However, other processes can also run on that CPU.

The database server supports automatic binding of CPU VPs to processors on multiprocessor host computers that support processor affinity. Your database server distribution includes a machine notes file that contains information about whether your version of the database server supports this feature. For information about where to find the machine notes file, see the Introduction to this guide.

You can use processor affinity for the purposes that the following sections describe.

Related reference

 [VPCLASS configuration parameter \(Administrator's Reference\)](#)

Distributing computation impact:

You can use processor affinity to distribute the computation impact of CPU virtual processors (VPs) and other processes. On computers that are dedicated to the database server, assigning CPU VPs to all but one of the CPUs achieves maximum CPU utilization.

On computers that support both database server and client applications, you can bind applications to certain CPUs through the operating system. By doing so, you effectively reserve the remaining CPUs for use by database server CPU VPs, which you bind to the remaining CPUs with the VPCLASS configuration parameter. Set the **aff** option of the VPCLASS configuration parameter to the numbers of the CPUs on which to bind CPU VPs. For example, the following VPCLASS setting assigns CPU VPs to processors 4 to 7:

```
VPCLASS cpu,num=4,aff=(4-7)
```

When specifying a range of processors, you can also specify an incremental value with the range that indicates which CPUs in the range should be assigned to the virtual processors. For example, you can specify that the virtual processors are assigned to every other CPU in the range 0-6, starting with CPU 0.

```
VPCLASS CPU,num=4,aff=(0-6/2)
```

The virtual processors are assigned to CPUs 0, 2, 4, 6.

If you specify `VPCLASS CPU,num=4,aff=(1-10/3)`, the virtual processors are assigned to every third CPU in the range 1-10, starting with CPU 1. The virtual processors are assigned to CPUs 1, 4, 7, 10.

When you specify more than one value or range, the values and ranges do not have to be incremental or in any particular order. For example you can specify `aff=(8,12,7-9,0-6/2)`.

The database server assigns CPU virtual processors to CPUs in a circular pattern, starting with the first processor number that you specify in the *aff* option. If you specify a larger number of CPU virtual processors than physical CPUs, the database server continues to assign CPU virtual processors starting with the first CPU. For example, suppose you specify the following VPCLASS settings:

```
VPCLASS cpu,num=8,aff=(4-7)
```

The database server makes the following assignments:

- CPU virtual processor number 0 to CPU 4
- CPU virtual processor number 1 to CPU 5
- CPU virtual processor number 2 to CPU 6
- CPU virtual processor number 3 to CPU 7
- CPU virtual processor number 4 to CPU 4
- CPU virtual processor number 5 to CPU 5
- CPU virtual processor number 6 to CPU 6
- CPU virtual processor number 7 to CPU 7

Related reference

 [VPCLASS configuration parameter \(Administrator's Reference\)](#)

Isolating AIO VPs from CPU VPs:

On a system that runs database server and client (or other) applications, you can bind asynchronous I/O (AIO) VPs to the same CPUs to which you bind other application processes through the operating system. In this way, you isolate client applications and database I/O operations from the CPU VPs.

This isolation can be especially helpful when client processes are used for data entry or other operations that require waiting for user input. Because AIO VP activity usually comes in quick bursts followed by idle periods waiting for the disk, you can often interweave client and I/O operations without their unduly impacting each other.

Binding a CPU VP to a processor does not prevent other processes from running on that processor. Application (or other) processes that you do not bind to a CPU are free to run on any available processor. On a computer that is dedicated to the database server, you can leave AIO VPs free to run on any processor, which reduces delays on database operations that are waiting for I/O. Increasing the priority of AIO VPs can further improve performance by ensuring that data is processed quickly once it arrives from disk.

Avoiding a certain CPU:

The database server assigns CPU VPs to CPUs serially, starting with the CPU number you specify in this parameter. You might want to avoid assigning CPU VPs to a certain CPU that has a specialized hardware or operating-system function (such as interrupt handling).

Setting the number of AIO VPs

Use the **aio** and **num** options of the VPCLASS configuration parameter to indicate the number of AIO virtual processors that the database server brings up initially.

If your operating system does not support kernel asynchronous I/O (KAIO), the database server uses AIO virtual processors (VPs) to manage all database I/O requests.

If the VPCLASS configuration parameter does not specify the number of AIO VPs to start in the ONCONFIG file, then the setting of the AUTO_AIOVPS configuration parameter controls the number of AIO VPs:

- If AUTO_AIOVPS is set to 1 (on), the number of AIO VPs initially started is equal to the number of AIO chunks, up to a maximum of 128.
- If AUTO_AIOVPS is set to 0 (off), the number of AIO VPs started is equal to the greater of 6 or twice the number of AIO chunks, up to a maximum of 128.

The recommended number of AIO virtual processors depends on how many disks your configuration supports. If KAIO is *not* implemented on your platform, you should allocate one AIO virtual processor for each disk that contains database tables. You can add an additional AIO virtual processor for each chunk that the database server accesses frequently.

You can use the `AUTO_AIOVPS` configuration parameter to enable the database server to automatically increase the number of AIO virtual processors and page-cleaner threads when the server detects that AIO virtual processors are not keeping up with the I/O workload.

The machine notes file for your version of the database server indicates whether the operating system supports KAIO. If KAIO is supported, the machine notes describe how to enable KAIO on your specific operating system. For information about where to find the machine notes file, see the Introduction to this guide.

If your operating system supports KAIO, the CPU VPs make asynchronous I/O requests to the operating system instead of AIO virtual processors. In this case, configure only one AIO virtual processor, plus two additional AIO virtual processor for every file chunk that does not use KAIO.

If you use cooked files and if you enable direct I/O using the `DIRECT_IO` configuration parameter, you can reduce the number of AIO virtual processors. If the database server implements KAIO and if direct I/O is enabled, the database server will attempt to use KAIO, so you probably do not need more than one AIO virtual processor. Temporary dbspaces do not use direct I/O. If you have temporary dbspaces, you will probably need more than one AIO virtual processors.

Even when direct I/O is enabled with the `DIRECT_IO` configuration parameter, if the file system does not support either direct I/O or KAIO, you still must allocate two additional AIO virtual processors for every active dspace chunk that is not using KAIO.

The goal in allocating AIO virtual processors is to allocate enough of them so that the lengths of the I/O request queues are kept short (that is, the queues have as few I/O requests in them as possible). When the I/O request queues remain consistently short, I/O requests are processed as fast as they occur. Use the `onstat -g ioq` command to monitor the length of the I/O queues for the AIO virtual processors.

Allocate enough AIO VPs to accommodate the peak number of I/O requests. Generally, allocating a few extra AIO VPs is not detrimental. To start additional AIO VPs while the database server is in online mode, use the `onmode -p` command. You cannot drop AIO VPs in online mode.

Related reference

[➤ AUTO_AIOVPS Configuration Parameter \(Administrator's Reference\)](#)

[➤ VPCLASS configuration parameter \(Administrator's Reference\)](#)

Setting the `MULTIPROCESSOR` configuration parameter when using multiple CPU VPs

If you are running multiple CPU VPs, set the `MULTIPROCESSOR` configuration parameter to 1. When you set `MULTIPROCESSOR` to 1, the database server performs locking in a manner that is appropriate for a multiprocessor. Otherwise, set this parameter to 0.

The number of CPU VPs is used as a factor in determining the number of scan threads for a query. Queries perform best when the number of scan threads is a multiple (or factor) of the number of CPU VPs. Adding or removing a CPU VP can improve performance for a large query because it produces an equal distribution of scan threads among CPU VPs. For instance, if you have 6 CPU VPs and scan 10

table fragments, you might see a faster response time if you reduce the number of CPU VPs to 5, which divides evenly into 10. You can use **onstat -g ath** to monitor the number of scan threads per CPU VP or use **onstat -g ses** to focus on a particular session.

Related reference

[MULTIPROCESSOR Configuration Parameter \(Administrator's Reference\)](#)

Setting the SINGLE_CPU_VP configuration parameter when using one CPU VP

If you are running only one CPU VP, set the SINGLE_CPU_VP configuration parameter to 1. Otherwise, set this parameter to 0.

Important: If you set the SINGLE_CPU_VP parameter to 1, the value of the num option of the VPCLASS configuration parameter must also be 1.

Note: The database server treats user-defined virtual-processor classes (that is, VPs defined with VPCLASS) as if they were CPU VPs. Thus, if you set SINGLE_CPU_VP to nonzero, you cannot create any user-defined classes.

When you set the SINGLE_CPU_VP parameter to 1, you cannot add CPU VPs while the database server is in online mode.

Related reference

[SINGLE_CPU_VP configuration parameter \(Administrator's Reference\)](#)

[VPCLASS configuration parameter \(Administrator's Reference\)](#)

Optimizing access methods

The OPTCOMPIND configuration parameter helps the query optimizer choose an appropriate access method for your application. When the optimizer examines join plans, OPTCOMPIND indicates the preferred method for performing the join operation for an ordered pair of tables.

If OPTCOMPIND is equal to 0, the optimizer gives preference to an existing index (nested-loop join) even when a table scan might be faster. If OPTCOMPIND is set to 1 and the isolation level for a given query is set to Repeatable Read, the optimizer uses nested-loop joins.

When OPTCOMPIND is equal to 2, the optimizer selects a join method based on cost alone even though table scans can temporarily lock an entire table. For more information about OPTCOMPIND and the different join methods, see “Effect of OPTCOMPIND on the query plan” on page 10-21.

To set the value for OPTCOMPIND for specific applications or user sessions, set the **OPTCOMPIND** environment variable for those sessions. Values for this environment variable have the same range and semantics as for the configuration parameter.

Related reference

[OPTCOMPIND Configuration Parameter \(Administrator's Reference\)](#)

Setting the value of OPTCOMPIND within a session

You can set or change the value of OPTCOMPIND within a session for different kinds of queries. To do this, use the SET ENVIRONMENT OPTCOMPIND command, not the OPTCOMPIND configuration parameter.

For a DSS query, you should set the value of OPTCOMPIND to 2 or 1, and you should be sure that the isolation level is not set to Repeatable Read. For an OLTP query, you could set the value to 0 or 1 with the isolation level not set to Repeatable Read.

The value that you enter using the SET ENVIRONMENT OPTCOMPIND command takes precedence over the default setting specified in the ONCONFIG file. The default OPTCOMPIND setting is restored when the current session terminates. No other user sessions are affected by SET ENVIRONMENT OPTCOMPIND statements that you execute.

For more details about the SET ENVIRONMENT SQL statement and the syntax for SET ENVIRONMENT OPTCOMPIND, see the *IBM Informix Guide to SQL: Syntax*.

Related concepts

[➦ OPTCOMPIND Environment Option \(SQL Syntax\)](#)

Limiting PDQ resources in queries

The MAX_PDQPRIORITY configuration parameter limits the percentage of parallel database query (PDQ) resources that a query can use. Use MAX_PDQPRIORITY to limit the impact of large CPU-intensive queries on transaction throughput.

To limit the impact of large CPU-intensive queries on transaction throughput

Set the value of the MAX_PDQPRIORITY configuration parameter to an integer that represents a percentage of the following PDQ resources that a query can request:

- Memory
- CPU VPs
- Disk I/O
- Scan threads

When a query requests a percentage of PDQ resources, the database server allocates the MAX_PDQPRIORITY percentage of the amount requested, as the following formula shows:

$$\text{Resources allocated} = \text{PDQPRIORITY}/100 * \text{MAX_PDQPRIORITY}/100$$

For example, if a client uses the SET PDQPRIORITY 80 statement to request 80 percent of PDQ resources, but MAX_PDQPRIORITY is set to 50, the database server allocates only 40 percent of the resources (50 percent of the request) to the client.

For decision support and online transaction processing (OLTP), setting MAX_PDQPRIORITY allows the database server administrator to control the impact that individual decision-support queries have on concurrent OLTP performance. Reduce the value of MAX_PDQPRIORITY when you want to allocate more resources to OLTP processing. Increase the value of MAX_PDQPRIORITY when you want to allocate more resources to decision-support processing.

For more information about how to control the use of PDQ resources, see “The allocation of resources for parallel database queries” on page 12-7.

Related reference

[➔ MAX_PDQPRIORITY Configuration Parameter \(Administrator's Reference\)](#)

Limiting the performance impact of CPU-intensive queries

The DS_MAX_QUERIES configuration parameter specifies a maximum number of decision-support queries that can run at any one time. Queries with a low PDQ priority use proportionally fewer resources, so a larger number of those queries can run simultaneously. You can use the DS_MAX_QUERIES configuration parameter to limit the performance impact of CPU-intensive queries.

The DS_MAX_QUERIES configuration parameter controls only queries with a PDQ priority that is nonzero.

The database server uses the value of DS_MAX_QUERIES with DS_TOTAL_MEMORY to calculate quantum units of memory to allocate to a query. For more information about how the database server allocates memory to queries, see “The DS_TOTAL_MEMORY configuration parameter and memory utilization” on page 4-14.

Related reference

[➔ DS_MAX_QUERIES Configuration Parameter \(Administrator's Reference\)](#)

Limiting the number of PDQ scan threads that can run concurrently

The DS_MAX_SCANS configuration parameter limits the number of PDQ scan threads that can run concurrently. This configuration parameter prevents the database server from being flooded with scan threads from multiple decision-support queries.

To calculate the number of scan threads allocated to a query, use the following formula:

$$\text{scan_threads} = \min (nfrags, (DS_MAX_SCANS * pdqpriority / 100 * MAX_PDQPRIORITY / 100))$$

nfrags is the number of fragments in the table with the largest number of fragments.

pdqpriority

is the PDQ priority value set by either the PDQPRIORITY environment variable or the SQL statement SET PDQPRIORITY.

Reducing the number of scan threads can reduce the time that a large query waits in the ready queue, particularly when many large queries are submitted concurrently. However, if the number of scan threads is less than *nfrags*, the query takes longer once it is underway.

For example, if a query needs to scan 20 fragments in a table, but the *scan_threads* formula lets the query begin when only 10 scan threads are available, each scan thread scans two fragments serially. Query execution takes approximately twice as long as if 20 scan threads were used.

Related reference

 [DS_MAX_SCANS Configuration Parameter \(Administrator's Reference\)](#)

Configuring poll threads

The NETTYPE configuration parameter configures poll threads for each connection type that your instance of the database server supports. If your database server instance supports connections over more than one interface or protocol, you must specify a separate NETTYPE configuration parameter for each connection type.

You typically include a separate NETTYPE parameter for each connection type that is associated with a dbservername. You list dbservernames in the DBSERVERNAME and DBSERVERALIASES configuration parameters. You associate connection types with dbservernames through entries in the **sqlhosts** file or registry. For information about connection types and the **sqlhosts** file or registry, see connectivity information in your *IBM Informix Administrator's Guide*.

Related reference

“UNIX semaphore parameters” on page 3-1

 [NETTYPE Configuration Parameter \(Administrator's Reference\)](#)

Specifying the connection protocol

The first NETTYPE entry, which specifies the protocol for a given connection type, applies to all dbservernames associated with that type. Subsequent NETTYPE entries for that connection type are ignored.

NETTYPE entries are required for connection types that are used for outgoing communication only even if those connection types are not listed in the **sqlhosts** file or registry.

UNIX Only

The following protocols apply to UNIX platforms:

- IPCSHM
- TLITCP
- IPCSTR
- SOCTCP
- TLIIMC
- SOCIMC
- SQLMUX
- SOCSSL

Windows Only

The following protocols apply to Windows platforms:

- SOCTCP
- IPCNMP
- SQLMUX
- SOCSSL

Related reference

 [NETTYPE Configuration Parameter \(Administrator's Reference\)](#)

Specifying virtual-processor classes for poll threads

Each poll thread configured or added dynamically by a NETTYPE entry runs in a separate VP. A poll thread can run in one of two VP classes: NET and CPU. For best performance, use a NETTYPE entry to assign only one poll thread to the CPU VP class. Then assign all additional poll threads to NET VPs.

Related reference

 [NETTYPE Configuration Parameter \(Administrator's Reference\)](#)

Specifying the number of connections and poll threads

The optimum number of connections per poll thread is approximately 300 for uniprocessor computers and up to 350 for multiprocessor computers, although this can vary depending on the platform and database server workload.

A poll thread can support 1024 or perhaps more connections. If the FASTPOLL configuration parameter is enabled, you might be able to configure fewer poll threads, but should test the performance to determine the optimal configuration for your environment.

Each NETTYPE entry configures the number of poll threads for a specific connection type, the number of connections per poll thread, and the virtual-processor class in which those poll threads run, using the following comma-separated fields. There can be no white space within or between these fields.

NETTYPE *connection_type,poll_threads,conn_per_thread,vp_class*

connection_type

identifies the protocol-interface combination to which the poll threads are assigned. You typically set this field to match the *connection_type* field of a *dbservername* entry that is in the **sqlhosts** file or registry.

poll_threads

is the number of poll threads assigned to the connection type.

conn_per_thread

is the number of connections per poll thread. Use the following formula to calculate this number:

$$\text{conn_per_thread} = \text{connections} / \text{poll_threads}$$

connections

is the maximum number of connections that you expect the indicated connection type to support. For shared-memory connections (**ipcs**), double the number of connections for best performance.

This field is used only for shared memory connections on Windows. Other connection methods on Windows ignore this value.

For shared memory connection, the value of *conn_per_thread* is the maximum number of connections per thread. For network connections, the value of *conn_per_thread* can be exceeded.

vp_class

is the class of virtual processor that can run the poll threads. Specify CPU if you have a single poll thread that runs on a CPU VP. For best

performance, specify NET if you require more than one poll thread. If you are running Windows, specify NET in all cases. The default value for this field depends on the following conditions:

- If the connection type is associated with the `dbservername` that is listed in the `DBSERVERNAME` parameter, and no previous `NETTYPE` parameter specifies CPU explicitly, the default VP class is CPU. If the CPU class is already taken, the default is NET.
- If the connection type is associated with a `dbservername` that the `DBSERVERALIASES` parameter specifies, the default VP class is NET.

If the value of `conn_per_thread` exceeds 350 and the number of poll threads for the current connection type is less than the number of CPU VPs, you can improve performance by specifying the NET CPU class, adding poll threads (do not exceed the number of CPU VPs), and recalculating the value of `conn_per_thread`. The default value for `conn_per_thread` is 50.

Important: Each `ipcshm` connection requires a semaphore. Some operating systems require that you configure a maximum number of semaphores that can be requested by all software packages that run on the computer. For best performance, double the number of actual `ipcshm` connections when you allocate semaphores for shared-memory communications. See “UNIX semaphore parameters” on page 3-1.

If your computer is a uniprocessor and your database server instance is configured for only one connection type, you can omit the `NETTYPE` parameter. The database server uses the information provided in the `sqlhosts` file or registry to establish client/server connections.

If your computer is a uniprocessor and your database server instance is configured for more than one connection type, include a separate `NETTYPE` entry for each connection type. If the number of connections of any one type significantly exceeds 300, assign two or more poll threads, up to a maximum of the number of CPU VPs, and specify the NET VP class, as the following example shows:

```
NETTYPE ipcshm,1,200,CPU
NETTYPE tlitcp,2,200,NET # supports 400 connections
```

For `ipcshm`, the number of poll threads correspond to the number of memory segments. For example, if `NETTYPE` is set to 3,100 and you want one poll thread, set the poll thread to 1,300.

If your computer is a multiprocessor, your database server instance is configured for only one connection type, and the number of connections does not exceed 350, you can use `NETTYPE` to specify a single poll thread on either the CPU or the NET VP class. If the number of connections exceeds 350, set the VP class to NET, increase the number of poll threads, and recalculate `conn_per_thread`.

Important: You should carefully distinguish between poll threads for network connections and poll threads for shared memory connections, which should run one per CPU virtual processor. TCP connections should only be in network virtual processors, and you should only have the minimum needed to maintain responsiveness. Shared memory connections should only be in CPU virtual processors and should run in every CPU virtual processor.

Related reference

- [➡ NETTYPE Configuration Parameter \(Administrator's Reference\)](#)
- [➡ VPCLASS configuration parameter \(Administrator's Reference\)](#)

Enabling fast polling

You can use the FASTPOLL configuration parameter to enable or disable fast polling of your network, if your operating-system platform supports fast polling. Fast polling is beneficial if you have a large number of connections.

For example, if you have more than 300 concurrent connections with the database server, you can enable the FASTPOLL configuration parameter for better performance.

Related reference

- [➡ FASTPOLL Configuration Parameter \(Administrator's Reference\)](#)

Network buffer pools

The sizes of buffers for TCP/IP connections affect memory and CPU utilization. Sizing these buffers to accommodate a typical request can improve CPU utilization by eliminating the need to break up requests into multiple messages.

However, you must use this capability with care; the database server dynamically allocates buffers of the indicated sizes for active connections. Unless you carefully size buffers, they can use large amounts of memory. For details on how to size network buffers, see “Network buffer size” on page 3-18.

The database server dynamically allocates network buffers from the global memory pool for request messages from clients. After the database server processes client requests, it returns buffers to a common network buffer pool that is shared among sessions that use SOCTCP, IPCSTR, or TLITCP network connections.

This common network buffer pool provides the following advantages:

- Prevents frequent allocations and deallocations from the global memory pool
- Uses fewer CPU resources to allocate and deallocate network buffers to and from the common network buffer pool for each network transfer
- Reduces contention for allocation and deallocation of shared memory

The free network buffer pool can grow during peak activity periods. To prevent large amounts of unused memory from remaining in these network buffer pools when network activity is no longer high, the database server returns free buffers when the number of free buffers reaches specific thresholds.

The database server provides the following features to further reduce the allocation and deallocation of and contention for the free network buffers:

- A private free network buffer pool for each session to prevent frequent allocations and deallocations of network buffers from the common network buffer pool or from the global memory pool in shared memory
- Capability to specify a larger than 4-kilobyte buffer size to receive network packets or messages from clients

As the system administrator, you can control the free buffer thresholds and the size of each buffer with the following methods:

- NETTYPE configuration parameter
- IFX_NETBUF_PVTPOOL_SIZE environment variable
- IFX_NETBUF_SIZE environment variable and **b** (client buffer size) option in the `sqlhosts` file or registry

Network buffers

The database server implements a threshold of free network buffers to prevent frequent allocations and deallocations of shared memory for the network buffer pool. This threshold enables the database server to correlate the number of free network buffers with the number of connections that you specify in the NETTYPE configuration parameter.

The database server dynamically allocates network buffers for request messages from clients. After the database server processes client requests, it returns buffers to the network free-buffer pool.

If the number of free buffers is greater than the threshold, the database server returns the memory allocated to buffers over the threshold to the global pool.

The database server uses the following formula to calculate the threshold for the free buffers in the network buffer pool:

$$\text{free network buffers threshold} = 100 + (0.7 * \text{number_connections})$$

The value for *number_connections* is the total number of connections that you specified in the third field of the NETTYPE entry for the different type of network connections (SOCTCP, IPCSTR, or TLITCP). This formula does not use the NETTYPE entry for shared memory (IPCSHM).

If you do not specify a value in the third field of the NETTYPE parameter, the database server uses the default value of 50 connections for each NETTYPE entry corresponding to the SOCTCP, TLITCP, and IPCSTR protocols.

Support for private network buffers

The database server provides support for private network buffers for each session that uses SOCTCP, IPCSTR, or TLITCP network connections.

For situations in which many connections and sessions are constantly active, these private network buffers have the following advantages:

- Less contention for the common network buffer pool
- Fewer CPU resources to allocate and deallocate network buffers to and from the common network buffer pool for each network transfer

The IFX_NETBUF_PVTPOOL_SIZE environment variable specifies the size of the private network buffer pool for each session. The default size is one buffer. For more information about this environment variable, see the *IBM Informix Guide to SQL: Syntax*.

Use the **onstat** utility commands in the following table to monitor the network buffer usage.

Command	Output Field	Description
<code>onstat -g ntu</code>	q-pvt	The current number and highest number of buffers that are free in the private pool for this session
<code>onstat -g ntm</code>	q-exceeds	The number of times that the free buffer threshold was exceeded

The `onstat -g ntu` command displays the following format for the `q-pvt` output field:

```
current number / highest number
```

If the number of free buffers (value in `q-pvt` field) is consistently 0, you can perform one of the following actions:

- Increase the number of buffers with the environment variable `IFX_NETBUF_PVTPPOOL_SIZE`.
- Increase the size of each buffer with the environment variable `IFX_NETBUF_SIZE`.

The `q-exceeds` field indicates the number of times that the threshold for the shared network free-buffer pool was exceeded. When this threshold is exceeded, the database server returns the unused network buffers (over this threshold) to the global memory pool in shared memory. Optimally, this value should be 0 or a low number so that the server is not allocating or deallocating network buffers from the global memory pool.

Network buffer size

The `IFX_NETBUF_SIZE` environment variable specifies the size of each network buffer in the common network buffer pool and the private network buffer pool.

The default buffer size is 4 kilobytes.

The `IFX_NETBUF_SIZE` environment variable allows the database server to receive messages longer than 4 kilobytes in one system call. The larger buffer size reduces the amount of overhead required to receive each packet.

Increase the value of `IFX_NETBUF_SIZE` if you know that clients send greater than 4-kilobyte packets. Clients send large packets during any of the following situations:

- Loading a table
- Inserting rows greater than 4 kilobytes
- Sending simple large objects

The `b` option for `sqlhosts` allows the client to send and receive greater than 4 kilobytes. The value for the `sqlhosts` option should typically match the value for `IFX_NETBUF_SIZE`.

You can use the following `onstat` command to see the network buffer size:

```
onstat -g afr global | grep net
```

The `size` field in the output shows the network buffer size in bytes.

Related reference

- [🔗 Configure connectivity \(Administrator's Guide\)](#)
- [🔗 IFX_NETBUF_SIZE environment variable \(SQL Reference\)](#)

Virtual processors and CPU utilization

While the database server is online, you can start and stop virtual processors (VPs) that belong to certain classes.

You can use **onmode -p** or IBM Informix Server Administrator (ISA), or ON-Monitor to start additional VPs for the following classes while the database server is online: CPU, AIO, PIO, LIO, SHM, TLI, and SOC. You can drop VPs of the CPU class only while the database server is online.

You should carefully distinguish between poll threads for network connections and poll threads for shared memory connections, which should run one per CPU virtual processor. TCP connections should only be in network virtual processors, and you should only have the minimum needed to maintain responsiveness. Shared memory connections should only be in CPU virtual processors and should run in every CPU virtual processor

Adding virtual processors

Whenever you add a network VP (SOC or TLI), you also add a poll thread. Every poll thread runs in a separate VP, which can be either a CPU VP or a network VP of the appropriate network type.

Adding more VPs can increase the load on CPU resources, so if the NETTYPE value indicates that an available CPU VP can handle the poll thread, the database server assigns the poll thread to that CPU VP. If all the CPU VPs have poll threads assigned to them, the database server adds a second network VP to handle the poll thread.

Monitoring virtual processors

Monitor the virtual processors to determine if the number of virtual processors configured for the database server is optimal for the current level of activity.

To monitor virtual processors:

- Use command-line utilities, such as **onstat-g ioq** to view information. See “Using some **onstat-g** commands to monitor virtual processors”
- Use the **AUTO_AIOVPS** configuration parameter to enable the database server to automatically increase the number of AIO virtual processors and page-cleaner threads when the server detects that AIO virtual processors are not keeping up with the I/O workload.
- Query SMI tables. See “Using SMI tables to monitor virtual processors” on page 3-22.

Using some onstat-g commands to monitor virtual processors

You can use the **onstat-g glo**, **onstat-g rea**, and **onstat-g ioq** commands to monitor virtual processors.

Monitor virtual processors with the onstat-g glo command:

Use the **onstat-g glo** command to display information about each virtual processor that is currently running and to display cumulative statistics for each virtual-processor class.

The **vps** field in the following output sample shows the number of virtual processors that are currently active for that class. In the sample output, the **vps** field shows that 1 CPU VP is currently active.

```

MT global info:
sessions threads vps lngspins
0 28 11 0

total: sched calls thread switches yield 0 yield n yield forever
per sec: 0 19577737 16256991 3688561 11340793 280099 0

Virtual processor summary:
class vps usercpu syscpu total
cpu 1 107.40 8.09 115.49
aio 6 4.19 94.42 98.61
lio 1 0.68 3.54 4.22
pio 1 0.03 0.33 0.36
adm 1 0.00 0.05 0.05
msc 1 0.00 0.01 0.01
total 11 112.30 106.44 218.74

Individual virtual processors:
vp pid class usercpu syscpu total Thread Eff
1 5738 cpu 107.40 8.09 115.49 246.14 46%
2 5739 adm 0.00 0.05 0.05 0.00 0%
3 5740 lio 0.68 3.54 4.22 36.44 11%
4 5741 pio 0.03 0.33 0.36 7.50 4%
5 5742 aio 2.03 51.92 53.95 358.09 15%

```

Figure 3-1. **onstat -g glo** command output

Use the **onstat -g rea** command, as “Monitor virtual processors with the **onstat-g rea** command” describes, to determine if you need to increase the number of virtual processors.

Related reference

 **onstat -g glo** command: Print global multithreading information (Administrator's Reference)

Monitor virtual processors with the onstat-g rea command:

Use the **onstat-g rea** command to monitor the number of threads in the ready queue.

onstat-g rea displays this information:

- The **status** field in the output shows the value ready when the thread is in the ready queue.
- The **vp-class** output field shows the virtual processor class on which the thread executes.

If the number of threads in the ready queue is growing for a class of virtual processors (for example, the CPU class), you might have to add more of those virtual processors to your configuration.

Ready threads:							
tid	tcb	rstcb	prty	status	vp-class	name	
6	536a38	406464	4	ready	3cpu	main_loop()	
28	60cfe8	40a124	4	ready	1cpu	onmode_mon	
33	672a20	409dc4	2	ready	3cpu	sqlexec	

Figure 3-2. **onstat-g rea** output

Related reference

 [onstat -g rea](#) command: Print ready threads (Administrator's Reference)

Monitor virtual processors with the **onstat-g ioq** command:

Use the **onstat-g ioq** command to determine whether you need to allocate additional AIO virtual processors.

The **onstat-g ioq** command displays the length of the I/O queues under the column **len**, as the figure below shows. You can also see the maximum queue length (since the database server started) in the **maxlen** column. If the length of the I/O queue is growing, I/O requests are accumulating faster than the AIO virtual processors can process them. If the length of the I/O queue continues to show that I/O requests are accumulating, consider adding AIO virtual processors.

```

onstat -g ioq

AIO I/O queues:
q name/id   len maxlen totalops dskread dskwrite dskcopy
adt 0       0       0         0         0         0
msc 0       0       1         12         0         0
aio 0       0       4         89         68         0
pio 0       0       1          1          0          1
lio 0       0       1         17          0         17
kio 0       0       0          0          0          0
gfd 3       0       3         254        242        12
gfd 4       0       17        614        261        353

onstat -d

Dbspaces
address number  flags  fchunk  nchunks  flags  owner  name
alde1d8 1          1      1        1         N      informix rootdbs
aldf550 2          1      2        1         N      informix spacel
2 active, 32,678 maximum
Chunks
address chk/dbs offset  size  free  bpages  flags  pathname
alde320 1 1 0     75000 66447  P0-   /ix/root_chunk
aldf698 2 2 0     500   447   P0-   /ix//chunk1
2 active, 32,678 maximum

```

Figure 3-3. **onstat-g ioq** and **onstat -d** output

Each chunk serviced by the AIO virtual processors has one line in the **onstat-g ioq** output, identified by the value **gfd** in the **q name** column. You can correlate the line in **onstat -g ioq** with the actual chunk because the chunks are in the same order as in the **onstat -d** output. For example, in the **onstat-g ioq** output, there are two **gfd** queues. The first **gfd** queue holds requests for **root_chunk** because it

corresponds to the first chunk shown in the **onstat -d** output. Likewise, the second gfd queue holds requests for **chunk1** because it corresponds to the second chunk in the **onstat -d** output.

If the database server has a mixture of raw devices and cooked files, the gfd queues correspond only to the cooked files in **onstat -d** output.

Related reference

 [onstat -g ioq command: Print I/O queue information \(Administrator's Reference\)](#)

Using ISA to monitor virtual processors

You can use ISA to display information about virtual processors, and to monitor, add, or remove virtual-processor classes

To monitor virtual processors with ISA, click the **VPs** page on the main ISA page. ISA uses information that the **onstat -g glo** command-line option generates. Click **Refresh** to rerun the commands and display fresh information.

Using SMI tables to monitor virtual processors

You can get information from system-monitoring interface (SMI) tables to use to monitor virtual processors.

You must connect to the **sysmaster** database to query the SMI tables. Query the **sysvpprof** SMI table to obtain information about the virtual processors that are currently running. This table contains the following columns.

Column	Description
vpid	ID number of the virtual processor
class	Class of the virtual processor
usercpu	Seconds of user CPU consumed
syscpu	Seconds of system CPU consumed

CPU virtual processor memory caches

Each CPU virtual processor can optionally have a private memory cache associated with it. The purpose of this cache is to improve access time to memory blocks.

Each private memory cache block consists of 1 to 32 memory pages, where each memory page is 4096 bytes.

Normally the database server performs a bit map search to find memory blocks of a requested length. In some circumstances, this search can be slow. This search also requires a lock, which can affect concurrency on large multiprocessor computers. You can avoid this problem and improve concurrency if you use a private memory cache.

A private memory cache can increase memory consumption.

Use the **VP_MEMORY_CACHE_KB** configuration parameter to enable a private memory cache and specify information about the memory cache. See “Enabling private memory caches” on page 3-23. Also see “Obtaining CPU VP memory block cache statistics” on page 3-23.

Related reference

[📄 VP_MEMORY_CACHE_KB Configuration Parameter \(Administrator's Reference\)](#)

Enabling private memory caches

You can use the `VP_MEMORY_CACHE_KB` configuration parameter to enable a private memory cache and specify information about the memory cache.

To enable a private memory cache:

1. Check the value specified in the `SHMTOTAL` configuration parameter. This value specifies the total amount of shared memory (resident, virtual, communications, and virtual extension portions) that the database server uses for all memory allocations.
2. Set the `VP_MEMORY_CACHE_KB` configuration parameter, which specifies the amount of memory for each CPU VP, to a value that ranges from a minimum of 800 kilobytes to an amount that does not exceed 40 percent of the memory limit that is specified in the `SHMTOTAL` configuration parameter.

In most cases, you should set the `VP_MEMORY_CACHE_KB` configuration parameter to a value that is much smaller than the maximum value of 40 percent of the memory limit that is specified in the `SHMTOTAL` configuration parameter. A smaller value should result in a high cache hit ratio and not bind memory blocks to a single CPU VP. In addition, while normal database server memory-management routines can combine adjacent free blocks of memory, the CPU VP memory cache does not combine adjacent free memory blocks.

To change memory cache information, use the `onmode -wf` or `-wm` options. The `onmode -wf` option changes the information immediately.

If you set these `onmode` options to 0, the database server empties and disables the private memory caches.

Related concepts

“Obtaining CPU VP memory block cache statistics”

Related reference

[📄 VP_MEMORY_CACHE_KB Configuration Parameter \(Administrator's Reference\)](#)

[📄 SHMTOTAL configuration parameter \(Administrator's Reference\)](#)

Obtaining CPU VP memory block cache statistics

You can view information about CPU VP memory block cache statistics by using the `onstat -g vpcache` option.

Information displayed includes the size of the memory blocks in 4096 byte blocks and the current number of blocks.

Related tasks

“Enabling private memory caches” on page 3-23

Related reference

 `onstat -g vpcache` command: Print CPU VP memory block cache statistics (Administrator's Reference)

Connections and CPU utilization

Some applications have a large number of client/server connections. Opening and closing connections can consume a large amount of system CPU time.

The following topics describe ways that you might be able to reduce the system CPU time required to open and close connections.

Multiplexed connections and CPU utilization

Many traditional nonthreaded SQL client applications use multiple database connections to perform work for a single user. Each database connection establishes a separate network connection to the database server. The multiplexed connection facility provides the ability for one network connection in the database server to handle multiple database connections from a client application.

Multiplexed connections enable the database server to create multiple database connections without consuming the additional computer resources that are required for additional network connections.

When a nonthreaded client uses a multiplexed connection, the database server still creates the same number of user sessions and user threads as with a nonmultiplexed connection. However, the number of network connections decreases when you use multiplexed connections. Instead, the database server uses a multiplex listener thread to allow the multiple database connections to share the same network connection.

To improve response time for nonthreaded clients, you can use multiplexed connections to execute SQL queries. The amount of performance improvement depends on the following factors:

- The decrease in total number of network connections and the resulting decrease in system CPU time

The usual cause for a large amount of system CPU time is the processing of system calls for the network connection. Therefore, the maximum decrease in system CPU time is proportional to the decrease in the total number of network connections.

- The ratio of this decrease in system CPU time to the user CPU time

If the queries are simple and use little user CPU time, you might experience a sizable reduction in response time when you use a multiplexed connection. But if the queries are complex and use a large amount of user CPU time, you might not experience a performance improvement.

To get an idea of the amounts of system CPU time and user CPU times per virtual processor, use the **onstat -g glo** option.

To use multiplexed connections for a nonthreaded client application, you must take the following steps before you bring up the database server:

1. Define an alias using the `DBSERVERALIASES` configuration parameter. For example, specify:

```
DBSERVERALIASES ids_mux
```

2. Add an SQLHOSTS entry for the alias using sqlmux as the **nettype** entry, which is the second column in the SQLHOSTS file. For example, specify:

```
ids_mux onsqlmux .....
```

The other fields in this entry, the **hostname** and **servicename**, must be present, but they are ignored.

3. Enable multiplexing for the selected connection types by specifying `m=1` in the **sqlhosts** file or registry that the client uses for the database server connection.
4. On Windows platforms, you must also set the **IFX_SESSION_MUX** environment variable.

Warning: On Windows, a multithreaded application must not use the multiplexed connection feature. If a multithreaded application enables the multiplexing option in the **sqlhosts** registry entry and also defines the **IFX_SESSION_MUX** environment variable, it can produce disastrous results, including crashing and data corruption.

For more information about restrictions on the use of multiplexed connections, see the *IBM Informix ESQL/C Programmer's Manual* and your *IBM Informix Administrator's Guide*.

MaxConnect for multiple connections (UNIX)

IBM Informix MaxConnect is a networking product for Informix database server environments on UNIX. You can use Informix MaxConnect to manage large numbers (from several hundred to tens of thousands) of client/server connections. Informix MaxConnect is best for OLTP data transfers, but is not recommended for large multimedia data transfers.

Informix MaxConnect provides the following performance advantages for medium to large OLTP configurations:

- Reduces CPU requirements on the database server by reducing the number of physical connections.
Informix MaxConnect multiplexes connections so that the ratio of client connections to database connections can be 100:1 or higher.
- Improves end-user response time by increasing system scalability to many thousands of connections
- Reduces operating-system overhead by aggregating multiple small packets into one transfer operation

To obtain maximum performance benefit, install Informix MaxConnect on either a dedicated computer to which Informix clients connect or on the client application server. Either of these configurations offloads the CPU requirements of handling a large number of connections from the database server computer.

To monitor Informix MaxConnect, use the **onstat -g imc** command on the database server computer and use the **imcadmin** command on the computer where Informix MaxConnect is located.

For more information about installing, configuring, monitoring, and tuning Informix MaxConnect, see the *IBM Informix MaxConnect User's Guide*.

Important: Informix MaxConnect and the *IBM Informix MaxConnect User's Guide* ship separately from IBM Informix.

Chapter 4. Effect of configuration on memory utilization

The combination of operating-system and Informix configuration parameters can affect memory utilization. You can change the settings of the Informix configuration parameters that directly affect memory utilization, and you can adjust the settings for different types of workloads.

Consider the amount of physical memory that is available on your host when you allocate shared memory for the database server. In general, if you increase space for database server shared memory, you can enhance the performance of your database server. You must balance the amount of shared memory dedicated to the database server against the memory requirements for VPs and other processes.

Shared memory

You must configure adequate shared-memory resources for the database server in your operating system. Insufficient shared memory can adversely affect performance.

The database server threads and processes require shared memory to share data by sharing access to segments of memory.

The shared memory that Informix uses can be divided into the following parts, each of which is comprised of one or more shared memory segments:

- Resident portion
- Virtual portion
- Message portion

The resident and message portions are static; you must allocate sufficient memory for them before you bring the database server into online mode. (Typically, you must reboot the operating system to reconfigure shared memory.) The virtual portion of shared memory for the database server grows dynamically, but you must still include an adequate initial amount for this portion in your allocation of operating-system shared memory.

The following topics provide information about each portion of shared memory and guidelines for estimating the size of each shared-memory portion for the database server so that you can allocate adequate space in the operating system:

- “Resident portion of shared memory” on page 4-2
- “Virtual portion of shared memory” on page 4-2
- “Message portion of shared memory” on page 4-3

The amount of space required is the total that all three portions of database server shared memory need. You specify the total amount of shared memory with the SHMTOTAL configuration parameter.

The LOCKS configuration parameter specifies the initial size of the lock table. If the number of locks that sessions allocate exceeds the value of LOCKS, the database server dynamically increases the size of the lock table. If you expect the lock table to grow dynamically, set SHMTOTAL to 0. When SHMTOTAL is 0, there is no limit on total memory (including shared memory) allocation.

Related reference

[📄 LOCKS Configuration Parameter \(Administrator's Reference\)](#)

[📄 SHMTOTAL configuration parameter \(Administrator's Reference\)](#)

Resident portion of shared memory

The resident portion of shared memory includes areas of shared memory that record the state of the database server, including buffers, locks, log files, and the locations of dbspaces, chunks, and tblspaces.

The settings that you use for the LOCKS, LOGBUFF, and PHYSBUFF configuration parameters help determine the size of the resident portion.

The BUFFERPOOL configuration parameter determines the amount of buffers allocated to the resident segment when the database server is started. Subsequent buffer pools that are added while the database server is running are moved into virtual memory until the database server is restarted.

In addition to these configuration parameters, which affect the size of the resident portion, the RESIDENT configuration parameter can affect memory utilization. When a computer supports forced residency and the RESIDENT configuration parameter is set to a value that locks the resident or resident and virtual portions, the resident portion is never paged out.

The machine notes file for your database server indicates whether your operating system supports forced residency.

On AIX and Solaris systems that support large pages, the IFX_LARGE_PAGES environment variable can enable the use of large pages for non-message shared memory segments that are locked in physical memory. If large pages have been configured by operating system commands and the RESIDENT configuration parameter specifies that some or all of the resident and virtual portions of shared memory are locked in physical memory, Informix will use large pages for the corresponding shared memory segments, provided sufficient large pages are available. The use of large pages can offer significant performance benefits in large memory configurations.

Related reference

“Configuration parameters that affect memory utilization” on page 4-8

[📄 IFX_LARGE_PAGES environment variable \(SQL Reference\)](#)

Virtual portion of shared memory

Informix uses the virtual portion of shared memory to allocate memory to each database server subsystem, as needed.

The virtual portion of shared memory for the database server includes the following components:

- Big buffers, which are used for large read and write I/O operations
- Sort-space pools
- Active thread-control blocks, stacks, and heaps
- User-session data
- Caches for SQL statements, data-dictionary information, and user-defined routines

- A global pool for network-interface message buffers and other information

The SHMVIRTSIZE configuration parameter in the ONCONFIG file provides the initial size of the virtual portion. As the need for additional space in the virtual portion arises, the database server adds shared memory in increments that the SHMADD or EXTSHMADD configuration parameter specifies, up to a limit on the total shared memory allocated to the database server, which the SHMTOTAL parameter specifies.

The size of the virtual portion depends primarily on the types of applications and queries that you are running. Depending on your application, an initial estimate for the virtual portion might be as low as 100 kilobytes per user or as high as 500 kilobytes per user, plus an additional 4 megabytes if you intend to use data distributions. For guidelines on creating data distributions, see UPDATE STATISTICS in “Creating data distributions” on page 13-13.

When a computer supports forced residency and the RESIDENT configuration parameter is set to a value that locks virtual segments, the virtual segments that are locked are never paged out.

On AIX and Solaris systems that support large pages, the IFX_LARGE_PAGES environment variable can enable the use of large pages for non-message shared memory segments that are locked in physical memory. If large pages have been configured by operating system commands and the RESIDENT configuration parameter specifies that some or all of the resident and virtual portions of shared memory are locked in physical memory, Informix will use large pages for the corresponding shared memory segments, provided sufficient large pages are available. The use of large pages can offer significant performance benefits in large memory configurations.

Related reference

“Configuration parameters that affect memory utilization” on page 4-8

 [IFX_LARGE_PAGES environment variable \(SQL Reference\)](#)

Message portion of shared memory

The message portion of shared memory contains the message buffers that the shared-memory communication interface uses. The amount of space required for these buffers depends on the number of user connections that you allow using a given networking interface.

If a particular interface is not used, you do not need to include space for it when you allocate shared memory in the operating system.

Estimating the size of the resident portion of shared memory

You can use formulas to estimate the size of the resident portion (in kilobytes) of shared memory when you allocate operating-system shared memory.

The result of your calculations is an estimate that normally, slightly exceeds the actual memory used for the resident portion of shared memory.

The following estimate was calculated to determine the resident portion of shared memory on a 64-bit server. The sizes shown are subject to change, and the calculation is approximate.

To estimate the size of the resident portion of shared memory

1. Estimate the size of the data buffer, using the following formula:

$$\text{buffer_value} = (\text{BUFFERS} * \text{pagesize}) + (\text{BUFFERS} * 254) + 250000$$

pagesize

is the shared-memory page size, as **onstat -b** displays it on the last line in the **buffer size** field.

If you have multiple buffer pools, add the buffer sizes for each buffer pool together.

2. Calculate the values in the following formulas:

$$\text{locks_value} = \text{LOCKS} * 44 \quad 44 \rightarrow 128$$

$$\text{logbuff_value} = \text{LOGBUFF} * 1024 * 3$$

$$\text{physbuff_value} = \text{PHYSBUFF} * 1024 * 2$$

3. Calculate the estimated size of the resident portion in kilobytes, using the following formula:

$$\text{rsize} = 1.02 * (\text{buffer_value} + \text{locks_value} + \text{logbuff_value} + \text{physbuff_value} + 51,200 \quad 51,200 \rightarrow 1,200,000) / 1024$$

Estimating the size of the virtual portion of shared memory

You can use a formula to estimate the initial size of the virtual portion of shared memory. You specify the initial size in the SHMVIRTSIZE configuration parameter.

The formula for estimating an initial size of the virtual portion of shared memory is as follows:

$$\text{shmvirtsize} = \text{fixed overhead} + \text{shared structures} + (\text{mncs} * \text{private structures}) + \text{other buffers}$$

To estimate a SHMVIRTSIZE value with the preceding formula

1. Estimate the value for the fixed overhead portion of the formula as follows:

$$\text{fixed overhead} = \text{global pool} + \text{thread pool after booting}$$

- a. Run the **onstat -g mem** command to obtain the pool sizes allocated to sessions.
- b. Subtract the value in the **reesize** field from the value in the **totalsize** to obtain the number of bytes allocated per session.
- c. Estimate a value for the *thread pool after booting* variable. This variable is partially dependent on the number of virtual processors.

2. Estimate the value of *shared structures*, using the following formula:

$$\text{shared structures} = \text{AIO vectors} + \text{sort memory} + \text{dbspace backup buffers} + \text{data-dictionary cache size} + \text{size of user-defined routine cache} + \text{histogram pool} + \text{STMT_CACHE_SIZE (SQL statement cache)} + \text{other pools (See onstat display.)}$$

For more information that might be useful for estimating the size of shared memory structure, see Table 4-1 on page 4-5.

3. Estimate the next part of the formula, as follows:

- a. Estimate the value of *mncs* (which is the maximum number of concurrent sessions) with the following formula:

$$\text{mncs} = \text{number of poll threads} * \text{number connections per poll thread}$$

The value for number of poll threads is the value that you specify in the second field of the NETTYPE configuration parameter.

The value for *number of connections per poll thread* is the value that you specify in the third field of the NETTYPE configuration parameter.

You can also obtain an estimate of the maximum number of concurrent sessions when you run the **onstat -u** command during peak processing. The last line of the **onstat -u** output contains the maximum number of concurrent user threads.

- b. Estimate the value of *private structures*, as follows:

$$\text{private structures} = \text{stack} + \text{heap} + \text{session control-block structures}$$

stack is generally 32 kilobytes but dependent on recursion in user-defined routines. You can obtain the stack size for each thread with the **onstat -g sts** option.

heap is about 15 kilobytes. You can obtain the heap size for an SQL statement when you use the **onstat -g stm** option. (For more information about the **onstat -g stm** option, see “Session memory” on page 4-43.)

session control-block structures is the amount of memory used per session. The **onstat -g ses** option displays the amount of memory, in bytes, in the **total memory** column listed for each session id.

- c. Multiply the results of steps 3a and 3b to obtain the following part of the formula:

$$mncs * \text{private structures}$$

4. Estimate the value of *other buffers* to account for private buffers allocated for features such as lightweight I/O operations for smart large objects (about 180 kilobytes per user).
5. Add the results of steps 1 through 4 to obtain an estimate for the SHMVIRTSIZE configuration parameter.

Tip: When the database server is running with a stable workload, you can use **onstat -g seg** to obtain a precise value for the actual size of the virtual portion of shared memory. You can then use the value for shared memory that this command reports to reconfigure SHMVIRTSIZE.

To specify the size of segments that are added later to the virtual shared memory, set the SHMADD or EXTSHMADD configuration parameter.

The following table contains a list of additional topics that you can refer to when estimating the size of shared structures in memory.

Table 4-1. Information for shared-memory structures

Shared-Memory Structure	More Information
Sort memory	“Estimating memory needed for sorting” on page 7-14
Data-dictionary cache	“Data-dictionary configuration” on page 4-24
Data-distribution cache (histogram pool)	“Data-distribution configuration” on page 4-26
User-defined routine (UDR) cache	“SPL routine executable format stored in UDR cache” on page 10-32
SQL statement cache	“Enabling the SQL statement cache” on page 13-41 “SQL statement cache” on page 4-29

Table 4-1. Information for shared-memory structures (continued)

Shared-Memory Structure	More Information
Other pools	To see how much memory is allocated to the different pools, use the onstat -g mem command.

Related reference

[➡ SHMVIRTSIZE configuration parameter \(Administrator's Reference\)](#)

[➡ NETTYPE Configuration Parameter \(Administrator's Reference\)](#)

Estimating the size of the message portion of shared memory

You can estimate the size of the message portion of shared memory in kilobytes.

Estimate the size of the message portion of shared memory, using the following formula:

$$mmsgsize = (10,531 * ipcshm_conn + 50,000) / 1024$$

ipcshm_conn

is the number of connections that can be made using the shared-memory interface, as determined by the NETTYPE parameter for the **ipcshm** protocol.

Related reference

[➡ NETTYPE Configuration Parameter \(Administrator's Reference\)](#)

Configuring UNIX shared memory

On UNIX, you can configure shared-memory segments for the database server.

On UNIX, perform the following steps to configure the shared-memory segments that your database server configuration needs. For information about how to set parameters related to shared memory, see the configuration instructions for your operating system.

To configure shared-memory segments for the database server:

1. If your operating system does not have a size limit for shared-memory segments, take the following actions:
 - a. Set the operating-system configuration parameter for maximum segment size, typically SHMMAX or SHMSIZE, to the total size that your database server configuration requires. This size includes the amount of memory that is required to start your database server instance and the amount of shared memory that you allocate for dynamic growth of the virtual portion.
 - b. Set the operating-system configuration parameter for the maximum number of segments, typically SHMMNI, to at least 1 per instance of the database server.
2. If your operating system has a segment-size limit, take the following actions:
 - a. Set the operating-system configuration parameter for the maximum segment size, typically SHMMAX or SHMSIZE, to the largest value that your system allows.
 - b. Use the following formula to calculate the number of segments for your instance of the database server. If there is a remainder, round up to the nearest integer.

$$SHMMNI = total_shmem_size / SHMMAX$$

total_shmem_size

is the total amount of shared memory that you allocate for the database server use.

3. Set the operating-system configuration parameter for the maximum number of segments, typically SHMMNI, to a value that yields the total amount of shared memory for the database server when multiplied by SHMMAX or SHMSIZE. If your computer is dedicated to a single instance of the database server, that total can be up to 90 percent of the size of virtual memory (physical memory plus swap space).
4. If your operating system uses the SHMSEG configuration parameter to indicate the maximum number of shared-memory segments that a process can attach, set this parameter to a value that is equal to or greater than the largest number of segments that you allocate for any instance of the database server.

For additional tips on configuring shared memory in the operating system, see the machine notes file for UNIX or the release notes file for Windows. For the path name of each file, see the Introduction to this guide.

Related concepts

“The SHMADD and EXTSHMADD configuration parameters and memory utilization” on page 4-19

Freeing shared memory with onmode -F

You can run the **onmode -F** command to free shared-memory segments that are unavailable or no longer needed for a process.

The database server does not automatically free the shared-memory segments that it adds during its operations. After memory has been allocated to the database server virtual portion, the memory remains unavailable for use by other processes running on the host computer. When the database server runs a large decision-support query, it might acquire a large amount of shared memory. After the query completes, the database server no longer requires that shared memory. However, the shared memory that the database server allocated to service the query remains assigned to the virtual portion even though it is no longer needed.

The **onmode -F** command locates and returns unused 8-kilobyte blocks of shared memory that the database server still holds. Although this command runs only briefly (one or two seconds), **onmode -F** dramatically inhibits user activity while it runs. Systems with multiple CPUs and CPU VPs typically experience less degradation while this utility runs.

You should run **onmode -F** during slack periods with an operating-system scheduling facility (such as **cron** on UNIX). In addition, consider running this utility after you perform any task that substantially increases the size of database server shared memory, such as large decision-support queries, index builds, sorts, or backup operations.

Related reference

 [onmode -F: Free unused memory segments \(Administrator's Reference\)](#)

Configuration parameters that affect memory utilization

A large number of configuration parameters in the ONCONFIG file affect memory utilization and performance.

The following configuration parameters significantly affect memory utilization:

- BUFFERPOOL
- DS_NONPDQ_QUERY_MEM
- DS_TOTAL_MEMORY
- EXTSHMADD
- LOCKS
- LOGBUFF
- LOW_MEMORY_MGR
- LOW_MEMORY_RESERVE
- PHYSBUFF
- RESIDENT
- SHMADD
- SHMBASE
- SHMTOTAL
- SHMVIRT_SIZE
- SHMVIRT_ALLOCSEG
- STACKSIZE
- Memory cache parameters (see “Configuration parameters that affect memory caches” on page 4-23)
- Network buffer size (see “Network buffer pools” on page 3-16)

The SHMBASE parameter indicates the starting address for database server shared memory. When set according to the instructions in the machine notes file or release notes file, this parameter has no appreciable effect on performance. For the path name of each file, see the Introduction to this guide.

The DS_NONPDQ_QUERY_MEM parameter increases the amount of memory that is available for non-PDQ queries. You can only use this parameter if PDQ priority is set to zero. For more information, see “More memory for queries with hash joins, aggregates, and other memory-intensive elements” on page 13-33.

The following sections describe the performance effects and considerations associated with some of the configuration parameters that are listed at the beginning of this section. For additional details about these parameters, see the *IBM Informix Administrator's Reference*.

Related concepts

“Resident portion of shared memory” on page 4-2

“Virtual portion of shared memory” on page 4-2

Related reference

 [LOW_MEMORY_MGR configuration parameter \(Administrator's Reference\)](#)

Setting the size of the buffer pool, logical-log buffer, and physical-log buffer

The values that you specify for the BUFFERPOOL, DS_TOTAL_MEMORY, LOGBUFF, and PHYSBUFF configuration parameters depend on the type of applications that you are using (OLTP or DSS) and the page size.

Table 4-2 lists recommended settings for these parameters or guidelines for setting the parameters.

For information about estimating the size of the resident portion of shared memory, see “Estimating the size of the resident portion of shared memory” on page 4-3. This calculation includes figuring the size of the buffer pool, logical-log buffer, physical-log buffer, and lock table.

Table 4-2. Guidelines for OLTP and DSS Applications

Configuration Parameter	OLTP Applications	DSS Applications
BUFFERPOOL	The percentage of physical memory that you need for buffer space depends on the amount of memory that you have available on your system and the amount of memory that is used for other applications.	Set to a small buffer value and increase the DS_TOTAL_MEMORY value for light scans, queries, and sorts. For operations such as index builds that read data through the buffer pool, configure a larger number of buffers.
DS_TOTAL_MEMORY	Set to a value from 20 to 50 percent of the value of SHMTOTAL, in kilobytes.	Set to a value from 50 to 90 percent of SHMTOTAL.
LOGBUFF	If you are using unbuffered or ANSI logging, use the pages/io value in the logical-log section of the onstat -l output for the LOGBUFF value. If you are using buffered logging, keep the pages/io value low. The recommended LOGBUFF value is 16 to 32 kilobytes or 64 kilobytes for heavy workloads.	Because database or table logging is usually turned off for DSS applications, set LOGBUFF to 32 kilobytes.

Table 4-2. Guidelines for OLTP and DSS Applications (continued)

Configuration Parameter	OLTP Applications	DSS Applications
PHYSBUFF	If applications are using physical logging, check the pages/io value in the physical-log section of the onstat -l output to make sure the I/O activity is not too high. Set PHYSBUFF to a value that is divisible by the page size. The recommended PHYSBUFF value is 16 pages.	Because most DSS applications do not physically log, set PHYSBUFF to 32 kilobytes.

Related reference

- [➡ BUFFERPOOL configuration parameter \(Administrator's Reference\)](#)
- [➡ DS_TOTAL_MEMORY configuration parameter \(Administrator's Reference\)](#)
- [➡ LOGBUFF Configuration Parameter \(Administrator's Reference\)](#)
- [➡ PHYSBUFF Configuration Parameter \(Administrator's Reference\)](#)

The BUFFERPOOL configuration parameter and memory utilization

The BUFFERPOOL configuration parameter specifies the default values for buffers and LRU queues in a buffer pool for both the default page size buffer pool and for any non-default page size buffer pools. The information that you define in the BUFFERPOOL configuration parameter fields affects memory utilization.

You can specify a page size for a standard or temporary dbspace if you want a longer key length than is available for the default page size. The root dbspace is the default page size. If you want to specify a page size, the size must be an integral multiple of the default page size, and cannot be greater than 16 kilobytes. For systems with sufficient storage, the performance advantages of a larger page size include:

- Reduced depth of b-tree indexes, even for smaller index keys.
- Decreased checkpoint time, which typically occurs with larger page sizes.

Additional performance advantages occur because you can:

- Group on the same page long rows that currently span multiple pages of the default page size.
- Define a different page size for temporary tables, so the temporary tables have a separate buffer pool.

You can use the BUFFERPOOL configuration parameter to create a buffer pool that corresponds to the page size of the dbspace. (You might want to do this to implement a private buffer pool.) You can create buffer pools with page sizes that are not currently in use by any dbspace.

Important: Create the buffer pool before you create a standard or temporary dbspace with a non-default page size.

You cannot create multiple buffer pools with the same page size.

If you create a dbspace with a page size that does not have a corresponding buffer pool, the database server automatically creates a buffer pool using the default parameters defined in the ONCONFIG configuration file.

Information that was specified with the BUFFERS, LRUS, LRU_MAX_DIRTY, and LRU_MIN_DIRTY configuration parameters prior to Version 10.0 is also now specified using the BUFFERPOOL configuration parameter. When you create a buffer pool, you define information about the buffer pool including its size, the number of buffers in the buffer pool, the number of LRUs in the buffer pool, and **lru_min_dirty** and **lru_max_dirty** values.

Automatic LRU tuning changes affect all buffer pools and adjusts **lru_min_dirty** and **lru_max_dirty** values of the BUFFERPOOL configuration parameter.

If you do not specify a page size for a new buffer pool, the database server uses the operating system default page size (4K on Windows and 2K on most UNIX platforms) as the default page size for the buffer pool.

The ONCONFIG configuration file can contain one or more BUFFERPOOL lines. For example, on a computer with a 2K page size, the ONCONFIG file can contain up to nine lines, including the default specification.

The following example shows information for a buffer pool that is defined on an operating system with a 2K default page size:

```
BUFFERPOOL default,buffers=10000,lrus=8,lru_min_dirty=50.00, lru_max_dirty=60.50  
BUFFERPOOL size=2k,buffers=50000,lrus=8,lru_min_dirty=50, lru_max_dirty=60
```

The **buffers** field in the BUFFERPOOL configuration parameter specifies the number of data buffers available to the database server. These buffers reside in the resident portion of shared memory and are used to cache database data pages in memory.

If the value of **buffers** is zero (0) or if the value of **buffers** is missing in the BUFFERPOOL configuration parameter, the database server will not create the buffer pool of the specified page size.

When the database server is in online, quiescent, or administration mode, you can use the **onparams** utility to add a new buffer pool of a different size. When you use the **onparams** utility, the information that you specify about a buffer pool is automatically transferred to the ONCONFIG file.

When you use the **onparams** utility, you specify information as follows:

```
onparams -b -g <size of buffer page in Kbytes>  
-n <number of buffers>  
-r <number of LRUs>  
-x <max dirty (fractional value allowed)>  
-m <minimum dirty (fractional value allowed)>
```

For example:

```
onparams -b -g 6 -n 3000 -r 2 -x 2.0 -m 1.0
```

This adds 3000 buffers of size 6K bytes each with 2 LRUS with **lru_max_dirty** set at 2 percent and **lru_min_dirty** set at 1 percent.

The BUFFERPOOL configuration parameter has a significant effect on database I/O and transaction throughput. The more buffers that are available, the more

likely it is that a needed data page might already reside in memory as the result of a previous request. However, allocating too many buffers can affect the memory-management system and lead to excess operating system paging activity.

The database server uses the following formula to calculate the amount of memory to allocate for this data buffer pool:

$$\text{bufferpoolsize} = \text{BUFFERS} * \text{page_size}$$

In this formula *page_size* is the size of a page in memory for your operating system that **onstat -b** displays on the last line in the **buffer size** field, as the following sample output shows.

```
onstat -b
...

Buffers
address  userthread flgs pagenum  memaddr  nslots pgflgs xflgs owner   waitlist
2 modified, 0 resident, 200 total, 256 hash buckets, 4096 buffer size
```

On Windows, the page size is always 4 kilobytes (4096).

The percentage of physical memory that you need for buffer space depends on the amount of memory that you have available on your system and the amount of memory that is used for other applications. For systems with a large amount of available physical memory (4 gigabytes or more), buffer space might be as much as 90 percent of physical memory. For systems with smaller amounts of available physical memory, buffer space might range from 20 to 25 percent of physical memory.

Calculate all other shared-memory parameters after you specify the number of buffers in the **buffers** field and the bufferpool page size in the **size** field of the **BUFFERPOOL** configuration parameter.

For example, if your system has a page size of 2 kilobytes and 100 megabytes of physical memory, you can set the value in the **buffers** field to between 10,000 and 12,500, which allocates between 20 megabytes and 25 megabytes of memory.

Note: If you use non-default page sizes, you might need to increase the size of your physical log. If you perform many updates to non-default pages you might need a 150 to 200 percent increase of the physical log size. Some experimentation might be needed to tune the physical log. You can adjust the size of the physical log as necessary according to how frequently the filling of the physical log triggers checkpoints.

Related tasks

[Creating a dbspace with a non-default page size \(Administrator's Guide\)](#)

Related reference

[BUFFERPOOL configuration parameter \(Administrator's Reference\)](#)

[The onparams Utility \(Administrator's Reference\)](#)

[Create a buffer pool for the non-default page size \(Administrator's Guide\)](#)

[add bufferpool argument: Add a buffer pool \(SQL administration API\) \(Administrator's Reference\)](#)

64-Bit addressing and buffers:

To take advantage of the very large memory available on 64-bit addressing machines, increase the number of buffers in the buffer pool. This larger buffer pool increases the likelihood that a needed data page might already reside in memory.

Smart large objects and buffers:

By default, the database server reads smart large objects into the buffers in the resident portion of shared memory (also known as the buffer pool).

Depending upon your situation, you can take one of the following actions to achieve better performance for applications that use smart large objects:

- Use the buffer pool by default and increase the value of **buffers** in the **BUFFERPOOL** configuration parameter.

If your applications frequently access smart large objects that are 2 kilobytes or 4 kilobytes in size, use the buffer pool to keep them in memory longer.

Use the following formula to increase the value of buffers:

$$\text{Additional_BUFFERS} = \text{numcur_open_lo} * (\text{lo_userdata} / \text{pagesize})$$

In this formula:

- *numcur_open_lo* is the number of concurrently opened smart large objects that you can obtain from the **onstat -g smb fdd** option.
- *lo_userdata* is the number of bytes of smart-large-object data that you want to buffer.
- *pagesize* is the page size in bytes for the database server.

As a general rule, try to have enough buffers to hold two smart-large-object pages for each concurrently open smart large object. (The additional page is available for read-ahead purposes).

- Use lightweight I/O buffers in the virtual portion of shared memory.

Use lightweight I/O buffers only when you read or write smart large objects in operations greater than 8000 bytes and seldom access them. That is, if the read or write function calls read large amounts of data in a single-function invocation, use lightweight I/O buffers.

When you use lightweight I/O buffers, you can prevent the flood of smart large objects into the buffer pool and leave more buffers available for other data pages that multiple users frequently access. For more information, see “Lightweight I/O for smart large objects” on page 5-22.

Related reference

 [BUFFERPOOL configuration parameter \(Administrator's Reference\)](#)

Monitoring buffers:

You can monitor buffers and bufferpool activity with specific **onstat** options.

The following **onstat** options display information that you can use to monitor buffers and bufferpool activity:

- The **-b** and **-B** options display general buffer information.
- The **-R** option displays LRU queue statistics.
- The **-X** option displays information about the database server I/O threads that are waiting for buffers.
- The **-p** option displays page information, including buffer pool statistics.

You can also use **onstat -p** to monitor the read-cache rate of the buffer pool. This rate represents the percentage of database pages that are already present in a shared-memory buffer when a query requests a page. (If a page is not already present, the database server must copy it into memory from disk.) If the database server finds the page in the buffer pool, it spends less time on disk I/O. Therefore, you want a high read-cache rate for good performance. For OLTP applications where many users read small sets of data, the goal is to achieve a read cache rate of 95 percent or better.

If the read-cache rate is low, you can repeatedly increase buffers and restart the database server. As you increase the BUFFERPOOL value of buffers, you reach a point at which increasing the value no longer produces significant gains in the read-cache rate, or you reach the upper limit of your operating-system shared-memory allocation.

Use the memory-management monitor utility in your operating system (such as **vmstat** or **sar** on UNIX) to note the level of page scans and paging-out activity. If these levels rise suddenly or rise to unacceptable levels during peak database activity, reduce the BUFFERPOOL value of buffers.

The DS_TOTAL_MEMORY configuration parameter and memory utilization

The DS_TOTAL_MEMORY configuration parameter places a ceiling on the amount of shared memory that a query can obtain. You can use this parameter to limit the performance impact of large, memory-intensive queries. The higher you set this parameter, the more memory a large query can use, and the less memory is available for processing other queries and transactions.

For OLTP applications, set DS_TOTAL_MEMORY to between 20 and 50 percent of the value of SHMTOTAL, in kilobytes. For applications that involve large decision-support (DSS) queries, increase the value of DS_TOTAL_MEMORY to between 50 and 80 percent of SHMTOTAL. If you use your database server instance exclusively for DSS queries, set this parameter to 90 percent of SHMTOTAL.

A *quantum unit* is the minimum increment of memory allocated to a query. The Memory Grant Manager (MGM) allocates memory to queries in quantum units. The database server uses the value of DS_MAX_QUERIES with the value of DS_TOTAL_MEMORY to calculate a quantum of memory, according to the following formula:

$$\text{quantum} = \text{DS_TOTAL_MEMORY} / \text{DS_MAX_QUERIES}$$

To allow for more simultaneous queries with smaller quanta each, it is suggested that you increase DS_MAX_QUERIES. For more information about DS_MAX_QUERIES, see “Limiting the performance impact of CPU-intensive queries” on page 3-12. For more information about the MGM, see “The Memory Grant Manager” on page 12-6.

Related reference

 [DS_TOTAL_MEMORY configuration parameter \(Administrator's Reference\)](#)

Algorithm for determining DS_TOTAL_MEMORY:

The database server derives a value for DS_TOTAL_MEMORY if you do not set the DS_TOTAL_MEMORY configuration parameter or if you set this configuration parameter to an inappropriate value.

Whenever the database server changes the value that you assigned to DS_TOTAL_MEMORY, it sends the following message to your console:
DS_TOTAL_MEMORY recalculated and changed from *old_value* Kb
to *new_value* Kb

The variable *old_value* represents the value that you assigned to DS_TOTAL_MEMORY in your configuration file. The variable *new_value* represents the value that the database server derived.

When you receive the preceding message, you can use the algorithm to investigate what values the database server considers inappropriate. You can then take corrective action based on your investigation.

The following sections document the algorithm that the database server uses to derive the new value for DS_TOTAL_MEMORY.

Deriving a minimum for decision-support memory:

In the first part of the algorithm that the database server uses to derive the new value for the DS_TOTAL_MEMORY configuration parameter, the database server establishes a minimum amount for decision-support memory.

When you assign a value to the DS_MAX_QUERIES configuration parameter, the database server sets the minimum amount of decision-support memory according to the following formula:

$$\text{min_ds_total_memory} = \text{DS_MAX_QUERIES} * 128 \text{ kilobytes}$$

When you do not assign a value to the DS_MAX_QUERIES configuration parameter, the database server uses the following formula instead, which is based on the value of information in the VPCLASS configuration parameter:

$$\text{min_ds_total_memory} = \text{NUMBER_CPUVPS} * 2 * 128 \text{ kilobytes}$$

Deriving a working value for decision-support memory:

In the second part of the algorithm that the database server uses to derive the new value for the DS_TOTAL_MEMORY configuration parameter, the database server establishes a working value for the amount of decision-support memory.

The database server verifies this amount in the third and final part of the algorithm.

When the DS_TOTAL_MEMORY configuration parameter is set:

When the DS_TOTAL_MEMORY configuration parameter is set, the database server checks whether the SHMTOTAL configuration parameter is set and then determines which formula to use to calculate the amount of decision-support memory.

When SHMTOTAL is set, the database server uses the following formula to calculate the amount of decision-support memory:

```
IF DS_TOTAL_MEMORY <= SHMTOTAL - nondecision_support_memory THEN
    decision_support_memory = DS_TOTAL_MEMORY
ELSE
    decision_support_memory = SHMTOTAL -
        nondecision_support_memory
```

This algorithm effectively prevents you from setting `DS_TOTAL_MEMORY` to values that the database server cannot possibly allocate to decision-support memory.

When `SHMTOTAL` is not set, the database server sets decision-support memory equal to the value that you specified in `DS_TOTAL_MEMORY`.

Related reference

[➔](#) `DS_TOTAL_MEMORY` configuration parameter (Administrator's Reference)

When the `DS_TOTAL_MEMORY` configuration parameter is not set:

When the `DS_TOTAL_MEMORY` configuration parameter is not set, the database server uses other sources to calculate a value for the amount of decision-support memory.

When `SHMTOTAL` is set, the database server uses the following formula to calculate the amount of decision-support memory:

$$\text{decision_support_memory} = \text{SHMTOTAL} - \text{nondecision_support_memory}$$

When the database server finds that you did not set `SHMTOTAL`, it sets decision-support memory as in the following example:

$$\text{decision_support_memory} = \text{min_ds_total_memory}$$

For a description of the variable `min_ds_total_memory`, see “Deriving a minimum for decision-support memory” on page 4-15.

Checking the derived value for decision-support memory:

In the final part of the algorithm that the database server uses to derive the new value for the `DS_TOTAL_MEMORY` configuration parameter, the database server verifies that the amount of shared memory is greater than `min_ds_total_memory` and less than the maximum possible memory space for your computer.

When the database server finds that the derived value for decision-support memory is less than the value of the `min_ds_total_memory` variable, it sets decision-support memory equal to the value of `min_ds_total_memory`.

When the database server finds that the derived value for decision-support memory is greater than the maximum possible memory space for your computer, it sets decision-support memory equal to the maximum possible memory space.

The `LOGBUFF` configuration parameter and memory utilization

The `LOGBUFF` configuration parameter determines the amount of shared memory that is reserved for each of the three buffers that hold the logical-log records until they are flushed to the logical-log file on disk. The size of a buffer determines how often it fills and therefore how often it must be flushed to the logical-log file on disk.

If you log smart large objects, increase the size of the logical-log buffers to prevent frequent flushing to the logical-log file on disk.

Related reference

[LOGBUFF Configuration Parameter \(Administrator's Reference\)](#)

The LOW_MEMORY_RESERVE configuration parameter and memory utilization

The LOW_MEMORY_RESERVE configuration parameter reserves a specific amount of memory, in kilobytes, for the database server to use when critical activities are needed and the server has limited free memory.

If you enable the new LOW_MEMORY_RESERVE configuration parameter by setting it to a specified value in kilobytes, critical activities, such as rollback activities, can complete even when you receive out-of-memory errors.

Related reference

[LOW_MEMORY_RESERVE configuration parameter \(Administrator's Reference\)](#)

[onstat -g seg command: Print shared memory segment statistics \(Administrator's Reference\)](#)

The PHYSBUFF configuration parameter and memory utilization

The PHYSBUFF configuration parameter determines the amount of shared memory that is reserved for each of the two buffers that serve as temporary storage space for data pages that are about to be modified. The size of a buffer determines how often it fills and therefore how often it must be flushed to the physical log on disk.

Choose a value for PHYSBUFF that is an even increment of the system page size.

Related reference

[PHYSBUFF Configuration Parameter \(Administrator's Reference\)](#)

The LOCKS configuration parameter and memory utilization

The LOCKS configuration parameter specifies the initial size of the lock table. The lock table holds an entry for each lock that a session uses. Each lock uses 120 bytes within a lock table. You must provide for this amount of memory when you configure shared memory.

If the number of locks needed by sessions exceeds the value set in the LOCKS configuration parameter, the database server attempts to increase the lock table by doubling its size. Each time that the lock table overflows (when the number of locks needed is greater than the current size of the lock table), the database server increases the size of the lock table, up to 99 times. Each time that the database server increases the size of the lock table, the server attempts to double its size. However, the server will limit each actual increase to no more than the maximum number of added locks shown in Table 4-3 on page 4-18. After the 99th time that the database server increases the lock table, the server no longer increases the size of the lock table, and an application needing a lock receives an error.

The following table shows the maximum number of locks allowed on 32-bit and 64-bit platforms

Table 4-3. Maximum number of locks on 32-bit and 64-bit platforms

Platform	Maximum Number of Initial Locks	Maximum Number of Dynamic Lock Table Extensions	Maximum Number of Locks Added Per Lock Table Extension	Maximum Number of Locks Allowed
32-bit	8,000,000	99	100,000	8,000,000 + (99 x 100,000)
64-bit	500,000,000	99	1,000,000	500,000,000 + (99 x 1,000,000)

The default value for the LOCKS configuration parameter is 20,000.

To estimate a different value for the LOCKS configuration parameter, estimate the maximum number of locks that a query needs and multiply this estimate by the number of concurrent users. You can use the guidelines in the following table to estimate the number of locks that a query needs.

Locks per Statement	Isolation Level	Table	Row	Key	TEXT or BYTE Data	CLOB or BLOB Data
SELECT	Dirty Read	0	0	0	0	0
SELECT	Committed Read	1	0	0	0	0
SELECT	Cursor Stability	1	1	0	0	1 lock for the CLOB or BLOB value or (if byte-range locking is used) 1 lock for each range
SELECT	Indexed Repeatable Read	1	Number of rows that satisfy conditions	Number of rows that satisfy conditions	0	1 lock for the CLOB or BLOB value or (if byte-range locking is used) 1 lock for each range
SELECT	Sequential Repeatable Read	1	0	0	0	1 lock for the CLOB or BLOB value or (if byte-range locking is used) 1 lock for each range
INSERT	Not applicable	1	1	Number of indexes	Number of pages in TEXT or BYTE data	1 lock for the CLOB or BLOB value
DELETE	Not applicable	1	1	Number of indexes	Number of pages in TEXT or BYTE data	1 lock for the CLOB or BLOB value
UPDATE	Not applicable	1	1	2 per changed key value	Number of pages in old plus new TEXT or BYTE data	1 lock for the CLOB or BLOB value or (if byte-range locking is used) 1 lock for each range

Important: During the execution of the SQL statement DROP DATABASE, the database server acquires and holds a lock on each table in the database until the entire DROP operation completes. Make sure that the value for LOCKS is large enough to accommodate the largest number of tables in a database.

Related concepts

“Configuring and managing lock usage” on page 8-12

Related reference

 LOCKS Configuration Parameter (Administrator's Reference)

The RESIDENT configuration parameter and memory utilization

The RESIDENT configuration parameter specifies whether shared-memory residency is enforced for the resident portion of database server shared memory. This configuration parameter works only on computers that support forced residency.

The resident portion in the database server contains the buffer pools that are used for database read and write activity. Performance improves when these buffers remain in physical memory.

You should set the RESIDENT parameter to 1. If forced residency is not an option on your computer, the database server issues an error message and ignores this configuration parameter.

On machines that support 64-bit addressing, you can have a very large buffer pool and the virtual portion of database server shared memory can also be very large. The virtual portion contains various memory caches that improve performance of multiple queries that access the same tables (see “Configuration parameters that affect memory caches” on page 4-23). To make the virtual portion resident in physical memory in addition to the resident portion, set the RESIDENT parameter to -1.

If your buffer pool is very large, but your physical memory is not very large, you can set RESIDENT to a value greater than 1 to indicate the number of memory segments to stay in physical memory. This specification makes only a subset of the buffer pool resident.

You can turn residency on or off for the resident portion of shared memory in the following ways:

- Use the **onmode** utility to reverse temporarily the state of shared-memory residency while the database server is online.
- Change the RESIDENT parameter to turn shared-memory residency on or off the next time that you start database server shared memory.

Related reference

 RESIDENT configuration parameter (Administrator's Reference)

The SHMADD and EXTSHMADD configuration parameters and memory utilization

The SHMADD configuration parameter specifies the size of each increment of shared memory that the database server dynamically adds to the virtual portion. The EXTSHMADD configuration parameter specifies the size of an extension segment that you add. Trade-offs are involved in determining the size of an increment.

Adding shared memory uses CPU cycles. The larger each increment, the fewer increments are required, but less memory is available for other processes. Adding

large increments is generally preferred; but when memory is heavily loaded (the scan rate or paging-out rate is high), smaller increments allow better sharing of memory resources among competing programs.

The range of values for SHMADD is 1024 through 4294967296 kilobytes on a 64-bit database server and 1024 through 524,288 on a 32-bit database server. The following table contains recommendations for setting SHMADD according to the size of physical memory.

Memory Size	SHMADD Value
256 megabytes or less	8192 kilobytes (the default)
Between 257 and 512 megabytes	16,384 kilobytes
Larger than 512 megabytes	32,768 kilobytes

The range of values for EXTSHMADD is 1024 through 524,288.

Note: A shared memory segment can be as large as 4 terabytes, depending on platform limits and the value of the SHMMAX kernel parameter. Use the **onstat -g seg** command to display the number of shared-memory segments that the database server is currently using.

Related tasks

“Configuring UNIX shared memory” on page 4-6

Related reference

[SHMADD Configuration Parameter \(Administrator's Reference\)](#)

[EXTSHMADD Configuration Parameter \(Administrator's Reference\)](#)

The SHMTOTAL configuration parameter and memory utilization

The SHMTOTAL configuration parameter places an absolute upper limit on the amount of shared memory that an instance of the database server can use.

If SHMTOTAL is set to 0 or left unassigned, the database server continues to attach additional shared memory as needed until no virtual memory is available on the system.

You can usually leave SHMTOTAL set to 0 except in the following cases:

- You must limit the amount of virtual memory that the database server uses for other applications or other reasons.
- Your operating system runs out of swap space and performs abnormally.

In the latter case, you can set SHMTOTAL to a value that is a few megabytes less than the total swap space that is available on your computer.

Related reference

 [SHMTOTAL configuration parameter \(Administrator's Reference\)](#)

The SHMVIRT_SIZE configuration parameter and memory utilization

The SHMVIRT_SIZE parameter specifies the size of the virtual portion of shared memory to allocate when you start the database server. The virtual portion of shared memory holds session- and request-specific data as well as other information.

Although the database server adds increments of shared memory to the virtual portion as needed to process large queries or peak loads, allocation of shared memory increases time for transaction processing. Therefore, you should set SHMVIRT_SIZE to provide a virtual portion large enough to cover your normal daily operating requirements. The size of SHMVIRT_SIZE can be as large as the SHMMAX configuration parameter allows.

The maximum value of SHMVIRT_SIZE, which must be a positive integer, is:

- 4 terabytes on a 64-bit database server
- 2 gigabytes on a 32-bit database server

For an initial setting, it is suggested that you use the larger of the following values:

- 8000
- $connections * 350$

The *connections* variable is the number of connections for all network types that are specified in the **sqlhosts** file or registry by one or more NETTYPE configuration parameters. (The database server uses $connections * 200$ by default.)

Once system utilization reaches a stable workload, you can reconfigure a new value for SHMVIRT_SIZE. As noted in “Freeing shared memory with onmode -F” on page 4-7, you can instruct the database server to release shared-memory segments that are no longer in use after a peak workload or large query.

Related reference

 [SHMVIRT_SIZE configuration parameter \(Administrator's Reference\)](#)

The SHMVIRT_ALLOCSEG configuration parameter and memory utilization

The SHMVIRT_ALLOCSEG configuration parameter specifies a threshold at which the database server should allocate memory. This configuration parameter also defines an alarm event security-code that is activated if the server cannot allocate the new memory segment, thus ensuring that the database server never runs out of memory.

When you set the SHMVIRT_ALLOCSEG configuration parameter, you must:

- Specify the percentage of memory used or the whole number of kilobytes remaining on the server. You cannot use negative values and values between 0 and .39.
- Specify the alarm event-security code, which is a value ranging from 1 (not noteworthy) to 5 (fatal). If you do not specify an event-security code, the server sets the value to 3, which is the default value.

Example 1:

```
SHMVIRT_ALLOCSEG 3000, 4
```

This specifies that if the database server has 3000 kilobytes remaining in virtual memory and additional kilobytes of memory cannot be allocated, the server raises an alarm level of 4.

Example 2:

```
SHMVIRT_ALLOCSEG .8, 4
```

This specifies that if the database server has twenty percent remaining in virtual memory and additional kilobytes of memory cannot be allocated, the server raises an alarm level of 4.

Related reference

 [Event Alarm Parameters \(Administrator's Reference\)](#)

 [SHMVIRT_ALLOCSEG configuration parameter \(Administrator's Reference\)](#)

The STACKSIZE configuration parameter and memory utilization

The STACKSIZE configuration parameter indicates the initial stack size for each thread. The database server assigns the amount of space that this parameter indicates to each active thread. This space comes from the virtual portion of database server shared memory. You can reduce the amount of shared memory that the database server adds dynamically.

To reduce the amount of shared memory that the database server adds dynamically, estimate the amount of the stack space required for the average number of threads that your system runs and include that amount in the value that you set for the SHMVIRT_SIZE configuration parameter.

To estimate the amount of stack space that you require, use the following formula:

$$\text{stacktotal} = \text{STACKSIZE} * \text{avg_no_of_threads}$$

avg_no_of_threads

is the average number of threads. You can monitor the number of active threads at regular intervals to determine this amount. Use **onstat -g sts** to check the stack use of threads. A general estimate is between 60 and 70 percent of the total number of connections (specified in the NETTYPE parameters in your ONCONFIG file), depending on your workload.

The database server also executes user-defined routines (UDRs) with user threads that use this stack. Programmers who write user-defined routines should take the following measures to avoid stack overflow:

- Do not use large automatic arrays.
- Avoid excessively deep calling sequences.
- *For DB-Access only:* Use **mi_call** to manage recursive calls.

If you cannot avoid stack overflow with these measures, use the STACK modifier of the CREATE FUNCTION statement to increase the stack for a particular routine.

Related reference

 STACKSIZE Configuration Parameter (Administrator's Reference)

Configuration parameters that affect memory caches

The database server uses caches to store information in memory instead of performing a disk read or some other operation to obtain the information. These memory caches improve performance for multiple queries that access the same tables. You can set some configuration parameters to increase the effectiveness of each cache.

The following table lists the Informix caches with their descriptions and information about the configuration parameters that you can use to set cache information.

Cache Name	Cache Description	Configuration Parameter and Description
Data Dictionary	Stores information about the table definition (such as column names and data types). For details, see "Data-dictionary cache."	DD_HASHSIZE: Number of buckets in data dictionary cache DD_HASHMAX: Number of tables that the database server can store in each bucket
Data Distribution	Stores distribution statistics for a column. For details, see "Data-distribution cache" on page 4-25.	DS_POOLSIZE: Total number of column distribution statistics that the database server can store in the data distribution cache DS_HASHSIZE: Number of buckets in data distribution cache
SQL Statement	Stores parsed and optimized SQL statements. For details, see "SQL statement cache configuration" on page 4-30.	STMT_CACHE: Enable the SQL statement cache STMT_CACHE_HITS: Number of times SQL statement is executed before caching STMT_CACHE_NOLIMIT: Prohibit entries into the SQL statement cache when allocated memory will exceed STMT_CACHE_SIZE STMT_CACHE_NUMPOOL: Number of memory pools for the SQL statement cache STMT_CACHE_SIZE: Size of the SQL statement cache in kilobytes
UDR	Stores frequently used UDRs (SPL routines and external routines). For details, see "SPL routine executable format stored in UDR cache" on page 10-32.	PC_POOLSIZE: Total number of user-defined routines and SPL routines in User-Defined Routine cache PC_HASHSIZE : Number of buckets in the User-Defined Routine cache

Data-dictionary cache

The first time that the database server accesses a table, it retrieves the information that it needs about the table (such as the column names and data types) from the system catalog tables on disk. After the database server has accessed the table, it places that information in the data-dictionary cache in shared memory.

Figure 4-1 on page 4-24 shows how the database server uses this cache for multiple users. User 1 accesses the column information for **tabid 120** for the first time. The database

server puts the column information in the data-dictionary cache. When user 2, user 3 and user 4 access the same table, the database server does not have to read from disk to access the data-dictionary information for the table. Instead, it reads the dictionary information from the data-dictionary cache in memory.

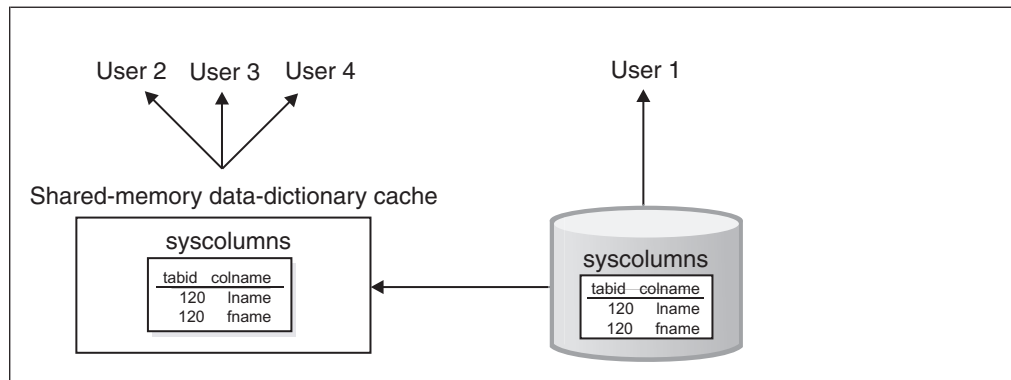

Figure 4-1. Data-dictionary cache

The database server still places pages for system catalog tables in the buffer pool, as it does all other data and index pages. However, the data-dictionary cache offers an additional performance advantage, because the data-dictionary information is organized in a more efficient format and organized to allow fast retrieval.

Data-dictionary configuration

The database server uses a hashing algorithm to store and locate information within the data-dictionary cache. The DD_HASHSIZE and DD_HASHMAX configuration parameters control the size of the data-dictionary cache.

To modify the number of buckets in the data-dictionary cache, use DD_HASHSIZE (must be a prime number). To modify the number of tables that can be stored in one bucket, use DD_HASHMAX.

For medium to large systems, you can start with the following values for these configuration parameters:

- DD_HASHSIZE: 503
- DD_HASHMAX: 4

With these values, you can potentially store information about 2012 tables in the data-dictionary cache, and each hash bucket can have a maximum of 4 tables.

If the bucket reaches the maximum size, the database server uses a least recently used mechanism to clear entries from the data dictionary.

Related reference

[DD_HASHSIZE Configuration Parameter \(Administrator's Reference\)](#)

[DD_HASHMAX configuration parameter \(Administrator's Reference\)](#)

Monitoring the data-dictionary cache

To obtain information for monitoring the data-dictionary cache, run the **onstat -g dic** command.

If commonly used tables are not listed in the data-dictionary cache, try increasing its size.

The following figure shows sample output for **onstat -g dic**.

```

Dictionary Cache: Number of lists: 31, Maximum list size: 10
list# size refcnt dirty? heapptr      table name
-----
  9   1   0    no    a210330  dawn@atlanta:informix.sysprocedures
 16   1   0    no    a46a420  dawn@atlanta:informix.orders
Total number of dictionary entries: 2

```

Figure 4-2. *onstat -g dic* output

The **onstat -g dic** output has the following fields.

Field	Description
Number of Lists	Number of buckets that DD_HASHSIZE specifies
Maximum List Size	Number of tables allowed in each bucket
List #	Bucket number
Size	Number of tables in the bucket
Ref cnt	Number of times that users have used the data-dictionary information for this table from the cache
Dirty	Designation if the data-dictionary information is no longer valid
Heap ptr	Heap pointer
Table name	Name of the table that the data-dictionary information describes

Data-distribution cache

The query optimizer uses distribution statistics generated by the UPDATE STATISTICS statement in the MEDIUM or HIGH mode to determine the query plan with the lowest cost. The first time that the optimizer accesses the distribution statistics for a column, the database server retrieves the statistics from the **sysdistrib** system catalog table on disk and places that information in the data-distribution cache in memory.

Figure 4-3 on page 4-26 shows how the database server accesses the data-distribution cache for multiple users. When the optimizer accesses the column distribution statistics for User 1 for the first time, the database server puts the distribution statistics in the data-distribution cache. When the optimizer determines the query plan for user 2, user 3 and user 4 who access the same column, the database server does not have to read from disk to access the data-distribution information for the table. Instead, it reads the distribution statistics from the data-distribution cache in shared memory.

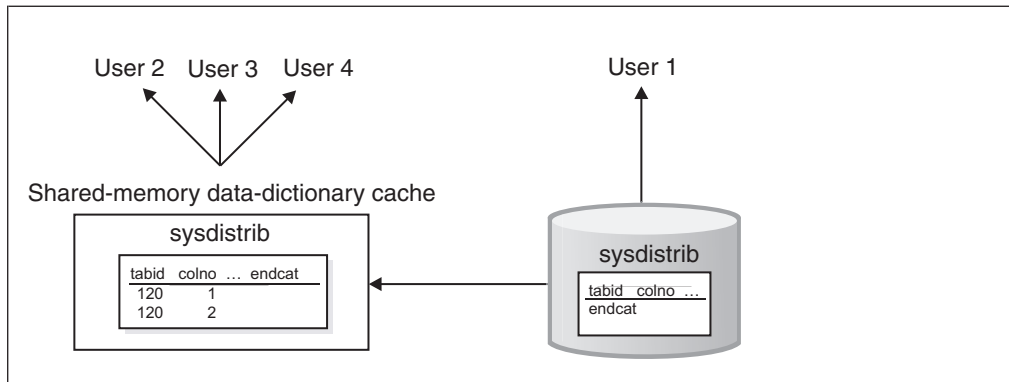

Figure 4-3. Data-distribution cache

The database server initially places pages for the **sysdistrib** system catalog table in the buffer pool as it does all other data and index pages. However, the data-distribution cache offers additional performance advantages. It:

- Is organized in a more efficient format
- Is organized to allow fast retrieval
- Bypasses the overhead of the buffer pool management
- Frees more pages in the buffer pool for actual data pages rather than system catalog pages
- Reduces I/O operations to the system catalog table

Data-distribution configuration

The database server uses a hashing algorithm to store and locate information within the data-distribution cache. The `DS_POOLSIZE` configuration parameter controls the size of the data-distribution cache and specifies the total number of column distributions that can be stored in the data-distribution cache.

To modify the number of buckets in the data-distribution cache, use the `DS_HASHSIZE` configuration parameter. The following formula determines the number of column distributions that can be stored in one bucket.

$$\text{Distributions_per_bucket} = \text{DS_POOLSIZE} / \text{DS_HASHSIZE}$$

To modify the number of distributions per bucket, change either the `DS_POOLSIZE` or `DS_HASHSIZE` configuration parameter.

For example, with the default values of 127 for `DS_POOLSIZE` and 31 for `DS_HASHSIZE`, you can potentially store distributions for about 127 columns in the data-distribution cache. The cache has 31 hash buckets, and each hash bucket can have an average of 4 entries.

The values that you set for `DS_HASHSIZE` and `DS_POOLSIZE`, depend on the following factors:

- The number of columns for which you execute `UPDATE STATISTICS` in `HIGH` or `MEDIUM` mode and you expect to be used most often in frequently executed queries.

If you do not specify columns when you run `UPDATE STATISTICS` for a table, the database server generates distributions for all columns in the table.

You can use the values of `DD_HASHSIZE` and `DD_HASHMAX` as guidelines for `DS_HASHSIZE` and `DS_POOLSIZE`. The `DD_HASHSIZE` and `DD_HASHMAX` specify the size for the data-dictionary cache, which stores information and statistics about tables that queries access.

For medium to large systems, you can start with the following values:

- DD_HASHSIZE 503
- DD_HASHMAX 4
- DS_HASHSIZE 503
- DS_POOLSIZE 2000

Monitor these caches to see the actual usage, and you can adjust these parameters accordingly. For monitoring information, see “Monitoring the data-distribution cache.”

- The amount of memory available

The amount of memory required to store distributions for a column depends on the level at which you run UPDATE STATISTICS. Distributions for a single column might require between 1 kilobyte and 2 megabytes, depending on whether you specify medium or high mode or enter a finer resolution percentage when you run UPDATE STATISTICS.

If the size of the data-distribution cache is too small, the following performance problems can occur:

- The database server uses the DS_POOLSIZE value to determine when to remove entries from the data-distribution cache. However, if the optimizer needs the dropped distributions for another query, the database server must reaccess them from the sysdistrib system catalog table on disk. The additional I/O and buffer pool operations to access sysdistrib on disk adds to the total response time of the query.

The database server tries to maintain the number of entries in data-distribution cache at the DS_POOLSIZE value. If the total number of entries reaches within an internal threshold of DS_POOLSIZE, the database server uses a least recently used mechanism to remove entries from the data-distribution cache. The number of entries in a hash bucket can go past this DS_POOLSIZE value, but the database server eventually reduces the number of entries when memory requirements drop.

- If DS_HASHSIZE is small and DS_POOLSIZE is large, overflow lists can be long and require more search time in the cache.

Overflow occurs when a hash bucket already contains an entry. When multiple distributions hash to the same bucket, the database server maintains an overflow list to store and retrieve the distributions after the first one.

If DS_HASHSIZE and DS_POOLSIZE are approximately the same size, the overflow lists might be smaller or even nonexistent, which might waste memory. However, the amount of unused memory is insignificant overall.

Related reference

[➤ DD_HASHSIZE Configuration Parameter \(Administrator's Reference\)](#)

[➤ DD_HASHMAX configuration parameter \(Administrator's Reference\)](#)

[➤ DS_POOLSIZE Configuration Parameter \(Administrator's Reference\)](#)

Monitoring the data-distribution cache

To monitor the size and use of the data-distribution cache, run **onstat -g dsc** or use the **ISA Performance -> Cache** menu options.

You might want to change the values of the DS_HASHSIZE and DS_POOLSIZE configuration parameters if you see the following situations:

- If the data-distribution cache is full most of the time and commonly used columns are not listed in the **distribution name** field, try increasing the values of DS_HASHSIZE and DS_POOLSIZE.
- If the total number of entries is much lower than DS_POOLSIZE, you can reduce the values of DS_HASHSIZE and DS_POOLSIZE.

Figure 4-2 on page 4-25 shows sample output for **onstat -g dsc**.

```

onstat -g dsc

Distribution Cache:
  Number of lists           : 31
  DS_POOLSIZE              : 127

Distribution Cache Entries:

list#id ref_cnt dropped? heap_ptr  distribution name
-----
5      0      0      0  aa8f820  vjp_stores@gilroy:utah.orders.order_num
12     0      0      0  aa90820  vjp_stores@gilroy:utah.items.order_num
15     0      0      0  a7e9a38  vjp_stores@gilroy:utah.customer.customer_num
19     0      0      0  aa3bc20  vjp_stores@gilroy:utah.customer.lname
21     0      0      0  aa3cc20  vjp_stores@gilroy:utah.orders.customer_num
28     0      0      0  aa91820  vjp_stores@gilroy:utah.customer.company

Total number of distribution entries: 6.
Number of entries in use      : 0

```

Figure 4-4. *onstat -g dsc* output

The **onstat -g dsc** output has the following fields.

Field	Description
Number of Lists	Number of buckets or lists that DS_HASHSIZE specifies
DS_POOLSIZE	Number of column distributions allowed in data-distribution cache
Number of entries	Number of column distributions currently in the data-distribution cache
Number of entries in use	Number of column distributions currently in use
List #	Hash bucket number
Id	Not used
Ref cnt	Number of SQL statements currently referencing the data-distribution information for this column from the cache

Field	Description
Dropped?	Designation if the column distribution has been dropped with the DROP DISTRIBUTIONS keyword on the UPDATE STATISTICS statement.
Heap ptr	Heap pointer
Distribution name	Name of the table and column that the data-distribution information describes

SQL statement cache

The SQL statement cache stores parsed and optimized SQL statements so that multiple users who execute the same SQL statement can achieve some performance improvements.

These performance improvements are:

- Reduced response times, because they bypass the parse and optimization steps, as Figure 4-5 on page 4-30 shows
- Reduced memory usage, because the database server shares query data structures among users

For more information about the effect of the SQL statement cache on the performance of individual queries, see “SQL statement cache” on page 13-39.

Figure 4-5 on page 4-30 shows how the database server accesses the SQL statement cache for multiple users.

- When the database server executes an SQL statement for User 1 for the first time, the database server checks whether the same exact SQL statement is in the SQL statement cache. If it is not in the cache, the database server parses the statement, determines the optimal query plan, and executes the statement.
- When User 2 executes the same exact SQL statement, the database server finds the statement in the SQL statement cache and does not need to parse and optimize the statement.
- Similarly, if User 3 and User 4 execute the same exact SQL statement, the database server does not have to parse and optimize the statement. Instead, it uses the parse information and query plan in the SQL statement cache in memory.

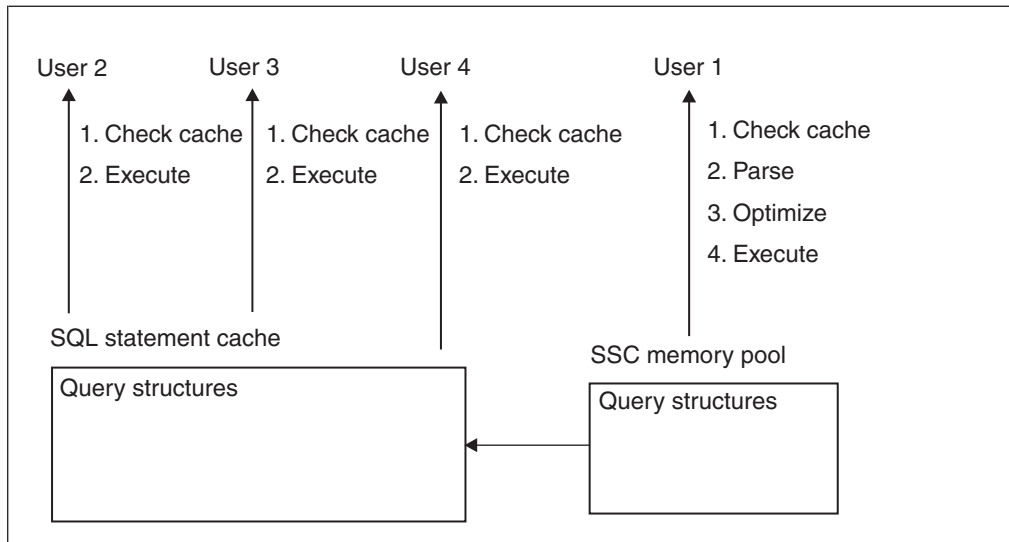

Figure 4-5. Database server actions when using the SQL statement cache

Prepared statements and the statement cache

Prepared statements are inherently cached for a single session. This means that if a prepared statement is executed many times or if a single cursor is opened many times, the session uses the same prepared query plan.

If a session prepares a statement and then executes it many times, the SQL statement cache does not affect performance, because the statement is optimized just once during the PREPARE statement.

However, if other sessions also prepare that same statement, or if the first session prepares the statement several times, the statement cache usually provides a direct performance benefit, because the database server only calculates the query plan once. Of course, the original session might gain a small benefit from the statement cache, even if it only prepares the statement once, because other sessions use less memory, and the database server does less work for the other sessions

SQL statement cache configuration

The value of the `STMT_CACHE` configuration parameter enables or disables the SQL statement cache.

For more information about how the value of the `STMT_CACHE` configuration parameter enables the SQL statement cache, see “Enabling the SQL statement cache” on page 13-41 describes.

Figure 4-6 on page 4-31 shows how the database server uses the values of the pertinent configuration parameters for the SQL statement cache. Further explanation follows the figure.

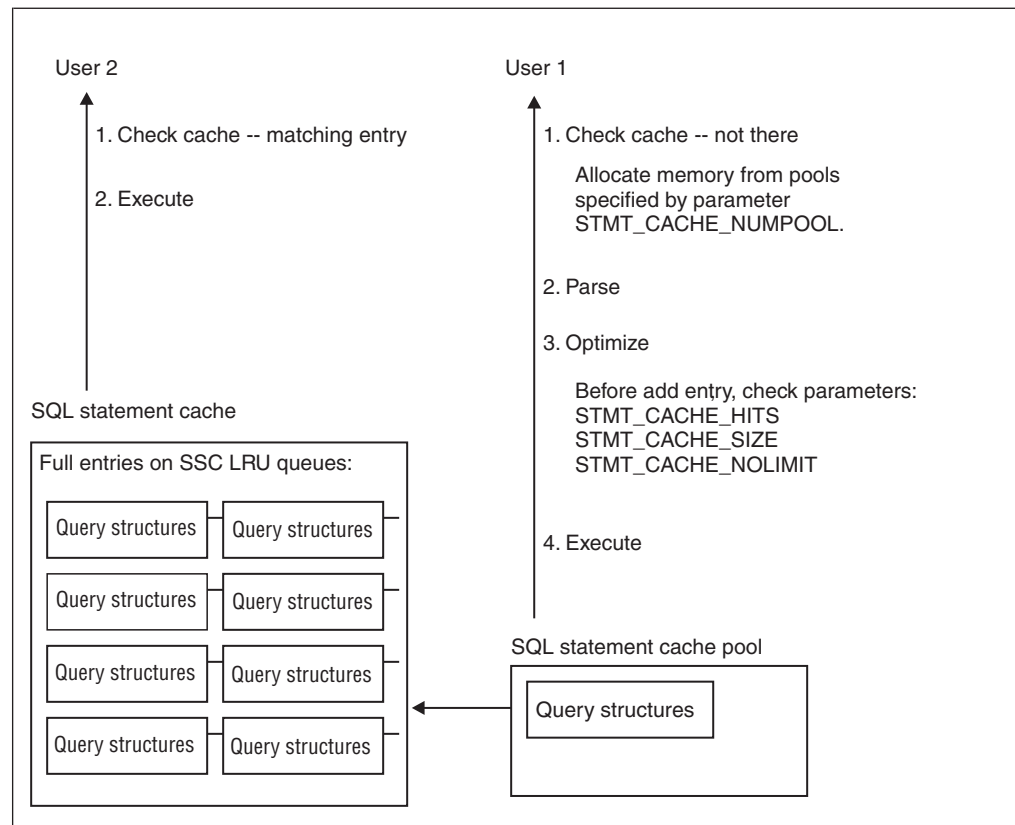

Figure 4-6. Configuration parameters that affect the SQL statement cache

When the database server uses the SQL statement cache for a user, it means the database server takes the following actions:

- Checks the SQL statement cache first for a match of the SQL statement that the user is executing
- If the SQL statement matches an entry, executes the statement using the query memory structures in the SQL statement cache (User 2 in Figure 4-6)
- If the SQL statement does not match an entry, the database server checks if it qualifies for the cache.

For information about what qualifies an SQL statement for the cache, see the SET STATEMENT CACHE statement in the *IBM Informix Guide to SQL: Syntax*.

- If the SQL statement qualifies, inserts an entry into the cache for subsequent executions of the statement.

The following parameters affect whether or not the database server inserts the SQL statement into the cache (User 1 in Figure 4-6):

- STMT_CACHE_HITS specifies the number of times the statement executes with an entry in the cache (referred to as *hit count*). The database server inserts one of the following entries, depending on the hit count:
 - If the value of STMT_CACHE_HITS is 0, inserts a fully cached entry, which contains the text of the SQL statement plus the query memory structures
 - If the value of STMT_CACHE_HITS is not 0 and the statement does not exist in the cache, inserts a key-only entry that contains the text of the SQL statement. Subsequent executions of the SQL statement increment the hit count.

- If the value of `STMT_CACHE_HITS` is equal to the number of hits for a key-only entry, adds the query memory structures to make a fully cached entry.
- `STMT_CACHE_SIZE` specifies the size of the SQL statement cache, and `STMT_CACHE_NOLIMIT` specifies whether or not to limit the memory of the cache to the value of `STMT_CACHE_SIZE`. If you do not specify the `STMT_CACHE_SIZE` parameter, it defaults to 524288 (512 * 1024) bytes.
The default value for `STMT_CACHE_NOLIMIT` is 1, which means the database server will insert entries into the SQL statement cache even though the total amount of memory might exceed the value of `STMT_CACHE_SIZE`.
When `STMT_CACHE_NOLIMIT` is set to 0, the database server inserts the SQL statement into the cache if the current size of the cache will not exceed the memory limit.

The following sections on `STMT_CACHE_HITS`, `STMT_CACHE_SIZE`, `STMT_CACHE_NOLIMIT`, `STMT_CACHE_NUMPOOL` and provide more details on how the following configuration parameters affect the SQL statement cache and reasons why you might want to change their default values.

Monitoring and tuning the SQL statement cache

You can monitor and tune various characteristics of the SQL statement cache. These characteristics include the number of times statements are read from the cache, the size of the cache, the amount of memory used, and the usage of cache pools.

The following table shows the tools you can use to monitor the different characteristics. ISA uses information that the following **onstat** command-line options generate to display information about the SQL statement cache. Click the **Refresh** button to rerun the **onstat** command and display fresh information.

SSC Characteristic to Monitor	Select on ISA	Displays the Output of	See
Number of times statements are read from the cache	Performance > Cache > Statement Cache	onstat -g ssc	"Number of SQL statement executions"
Size of the SQL statement cache	Performance > Cache > Statement Cache	onstat -g ssc	"Monitoring and tuning the size of the SQL statement cache" on page 4-35
Amount of memory used	Performance > Cache > Statement Cache	onstat -g ssc	"Memory limit and size" on page 4-37
Usage of the SQL statement cache pools	Performance > Locks > Latches	onstat -g spi	"Multiple SQL statement cache pools" on page 4-38

Number of SQL statement executions

When the SQL statement cache is enabled, the database server inserts a qualified SQL statement and its memory structures immediately in the SQL statement cache by default.

If your workload has a disproportionate number of ad hoc queries, use the `STMT_CACHE_HITS` configuration parameter to specify the number of times an SQL statement is executed before the database server places a fully cached entry in the statement cache.

When the `STMT_CACHE_HITS` configuration parameter is greater than 0 and the number of times the SQL statement has been executed is less than `STMT_CACHE_HITS`, the database server inserts key-only entries in the cache. This specification minimizes unshared memory structures from occupying the statement cache, which leaves more memory for SQL statements that applications use often.

Monitor the number of hits on the SQL statement cache to determine if your workload is using this cache effectively. The following sections describe ways to monitor the SQL statement cache hits.

Related concepts

“Too many single-use queries in the SQL statement cache” on page 4-36

Related reference

[STMT_CACHE_HITS Configuration Parameter \(Administrator's Reference\)](#)

Monitoring the number of hits on the SQL statement cache:

To monitor the number of hits in the SQL statement cache, run `onstat -g ssc`.

The `onstat -g ssc` option displays fully cached entries in the SQL statement cache. Figure 4-7 shows sample output for `onstat -g ssc`.

```
onstat -g ssc

Statement Cache Summary:
#lrus  currsz  maxsz  Poolsize  #hits  nolimit
4      49456   524288 57344    0      1

Statement Cache Entries:

lru hash ref_cnt  hits  flag heap_ptr  database  user
-----
0 153    0      0    -F a7e4690    vjp_stores  virginia
SELECT * FROM customer, orders
WHERE customer.customer_num = orders.customer_num
AND order_date > "01/01/07"

1 259    0      0    -F aa58c20    vjp_stores  virginia
SELECT * FROM customer, orders
WHERE customer.customer_num = orders.customer_num
AND order_date > "01/01/2007"

2 232    0      1    DF aa3d020    vjp_stores  virginia
SELECT C.customer_num, O.order_num
FROM customer C, orders O, items I
WHERE C.customer_num = O.customer_num
AND O.order_num = I.order_num

3 232    1      1    -F aa8b020    vjp_stores  virginia
SELECT C.customer_num, O.order_num
FROM customer C, orders O, items I
WHERE C.customer_num = O.customer_num
AND O.order_num = I.order_num

Total number of entries: 4.
```

Figure 4-7. `onstat -g ssc` output

Tip: The `onstat -g ssc` option is equivalent to the `onstat -g cac stmt` option in Version 9.2. The `onstat -g cac stmt` option in the current version of the database server displays the same columns as `onstat -g ssc`.

To monitor the number of times that the database server reads the SQL statement within the cache, look at the following output columns:

- In the Statement Cache Summary portion of the `onstat -g ssc` output, the `#hits` column is the value of the `SQL_STMT_HITS` configuration parameter.

In Figure 4-7 on page 4-33, the `#hits` column in the Statement Cache Summary portion of the output has a value of 0, which is the default value of the `STMT_CACHE_HITS` configuration parameter.

Important: The database server uses entries in the SQL statement cache only if the statements are exactly the same. The first two entries in Figure 4-7 on page 4-33 are not the same because each contains a different literal value in the `order_date` filter.

- In the Statement Cache Entries portion of the `onstat -g ssc` output, the `hits` column shows the number of times that the database server executed each individual SQL statement from the cache. In other words, the column shows the number of times that the database server uses the memory structures in the cache instead of parsing and optimizing the statements to generate them again.

The first time it inserts the statement in the cache, the `hits` value is 0.

- The first two SQL statements in Figure 4-7 on page 4-33 have a `hits` column value of 0, which indicates that each statement has been inserted into the cache but not yet executed from the cache.
- The last two SQL statements in Figure 4-7 on page 4-33 have a `hits` column value of 1, which indicates that these statements have been executed once from the cache.

The `hits` value for individual entries indicates how much sharing of memory structures is done. Higher values in the `hits` column indicates that the SQL statement cache is useful in improving performance and memory usage.

For a complete description of the output fields that `onstat -g ssc` displays, see “SQL statement cache information in `onstat -g ssc` output” on page 4-40.

Determining the number of nonshared entries in the SQL statement cache:

To determine how many nonshared entries exist in the SQL statement cache, run `onstat -g ssc all`.

The `onstat -g ssc all` option displays the key-only entries in addition to the fully cached entries in the SQL statement cache.

To determine how many nonshared entries exist in the cache:

1. Compare the `onstat -g ssc all` output with the `onstat -g ssc` output.
2. If the difference between these two outputs shows that many nonshared entries exist in the SQL statement cache, increase the value of the `STMT_CACHE_HITS` configuration parameter to allow more shared statements to reside in the cache and reduce the management overhead of the SQL statement cache.

You can use one of the following methods to change the `STMT_CACHE_HITS` parameter value:

- Update the `ONCONFIG` file to specify the `STMT_CACHE_HITS` configuration parameter. You must restart the database server for the new value to take effect.

You can use one of the following methods to update the ONCONFIG file:

- On ISA, navigate to the **Configuration** page and add the `STMT_CACHE_HITS` there. Then navigate to the **Mode** page and restart the database server.
- Use a text editor to edit the ONCONFIG file. Then bring down the database server with the `onmode -ky` command and restart with the `oninit` command.
- Increase the `STMT_CACHE_HITS` configuration parameter dynamically while the database server is running:

You can use any of the following methods to reset the `STMT_CACHE_HITS` value at run time:

- Use the ISA **Configuration** page to change the parameter setting to a larger number of hits.
- Issue the `onmode -W` command. The following example specifies that three (3) instances are required before a new query is added to the statement cache:

```
onmode -W STMT_CACHE_HITS 2
```

- Call the **ADMIN** or **TASK** function of the SQL administration API. The following example is equivalent to the `onmode` command in the previous example:

```
EXECUTE FUNCTION TASK("ONMODE", "W", "STMT_CACHE_HITS", "2");
```

If you increase `STMT_CACHE_HITS` dynamically without updating the configuration file, and the database server is subsequently restarted, the `STMT_CACHE_HITS` setting reverts the value in the ONCONFIG file. Therefore, if you want the setting to persist after subsequent restarts, modify the ONCONFIG file.

Monitoring and tuning the size of the SQL statement cache

If the size of the SQL statement cache is too small, performance problems can occur. You can monitor the effectiveness of the size of the SQL statement cache.

The following performance problems can occur:

- Frequently executed SQL statements are not in the cache
The statements used most often should remain in the SQL statement cache. If the SQL statement cache is not large enough, the database server might not have enough room to keep these statements when other statements come into the cache. For subsequent executions, the database server must reparse, reoptimize, and reinsert the SQL statement into the cache. Try increasing `STMT_CACHE_SIZE`.
- The database server spends a lot of time cleaning the SQL statement cache
The database server tries to prevent the SQL statement cache from allocating large amounts of memory by using a threshold (70 percent of the `STMT_CACHE_SIZE` parameter) to determine when to remove entries from the SQL statement cache. If the new entry causes the size of the SQL statement cache to exceed the threshold, the database server removes least recently used entries (that are not currently in use) before inserting the new entry.
However, if a subsequent query needs the removed memory structures, the database server must reparse and reoptimize the SQL statement. The additional processing time to regenerate these memory structures adds to the total response time of the query.

You can set the size of the SQL statement cache in memory with the `STMT_CACHE_SIZE` configuration parameter. The value of the parameter is the size in kilobytes. If `STMT_CACHE_SIZE` is not set, the default value is 512 kilobytes.

The `onstat -g ssc` output shows the value of `STMT_CACHE_SIZE` in the **maxsize** column. In Figure 4-7 on page 4-33, this **maxsize** column has a value of 524288, which is the default value ($512 * 1024 = 524288$).

Use the `onstat -g ssc` and `onstat -g ssc all` options to monitor the effectiveness of size of the SQL statement cache. If you do not see cache entries for the SQL statements that applications use most, the SQL statement cache might be too small or too many unshared SQL statement occupy the cache. The following sections describe how to determine these situations.

Related reference

 [STMT_CACHE_HITS Configuration Parameter \(Administrator's Reference\)](#)

Changing the size of the SQL statement cache:

You can analyze `onstat -g ssc all` output to determine if the SQL statement cache is too small. If the size of the cache is too small, you can change it.

To determine if the size of the SQL statement cache is too small:

1. Run `onstat -g ssc all` to determine if the cache is too small.
2. Look at the values in the following output columns in the Statement Cache Entries portion of the `onstat -g ssc all` output:
 - The **flags** column shows the current status of an SQL statement in the cache. A value of F in the second position indicates that the statement is currently fully cached. A value of - in the second position indicates that only the statement text (key-only entry) is in the cache. Entries with this - value in the second position appear in the `onstat -g ssc all` output, but not in the `onstat -g ssc` output.
 - The **hits** column shows the number of times the SQL statement has been executed, excluding the first time it is inserted into the cache.

If you do not see fully cached entries for statements that applications use most and the value in the **hits** column is large for the entries that do occupy the cache, then the SQL statement cache is too small.

To change the size of the SQL statement cache:

1. Update the value of the `STMT_CACHE_SIZE` configuration parameter.
2. Restart the database server for the new value to take effect.

Related reference

 [STMT_CACHE_HITS Configuration Parameter \(Administrator's Reference\)](#)

Too many single-use queries in the SQL statement cache:

When the database server places many queries that are only used once in the cache, they might replace statements that other applications use often. You can view `onstat -g ssc all` output to determine if too many unshared SQL statements occupy the cache. If so, you can prevent unshared SQL statements from being fully cached.

Look at the values in the following output columns in the Statement Cache Entries portion of the **onstat -g ssc all** output. If you see a lot of entries that have both of the following values, too many unshared SQL statements occupy the cache:

- **flags** column value of F in the second position
A value of F in the second position indicates that the statement is currently fully cached.
- **hits** column value of 0 or 1
The **hits** column shows the number of times the SQL statement has been executed, excluding the first time it is inserted into the cache.

Increase the value of the `STMT_CACHE_HITS` configuration parameter to prevent unshared SQL statements from being fully cached.

Related concepts

“Number of SQL statement executions” on page 4-32

Related reference

 [STMT_CACHE_HITS Configuration Parameter \(Administrator's Reference\)](#)

Memory limit and size

Although the database server tries to clean the SQL statement cache, sometimes entries cannot be removed because they are currently in use. In this case, the size of the SQL statement cache can exceed the value of the `STMT_CACHE_SIZE` configuration parameter.

The default value of the `STMT_CACHE_NOLIMIT` configuration parameter is 1, which means the database server inserts the statement even though the current size of the cache might be greater than the value of the `STMT_CACHE_SIZE` parameter.

If the value of the `STMT_CACHE_NOLIMIT` configuration parameter is 0, the database server does not insert either a fully-qualified or key-only entry into the SQL statement cache if the size will exceed the value of `STMT_CACHE_SIZE`.

Use the **onstat -g ssc** option to monitor the current size of the SQL statement cache. Look at the values in the following output columns of the **onstat -g ssc** output:

- The **currsz** column shows the number of bytes currently allocated in the SQL statement cache.
In Figure 4-7 on page 4-33, the **currsz** column has a value of 11264.
- The **maxsz** column shows the value of `STMT_CACHE_SIZE`.
In Figure 4-7 on page 4-33, the **maxsz** column has a value of 524288, which is the default value ($512 * 1024 = 524288$).

When the SQL statement cache is full and users are currently executing all statements within it, any new SQL statements that a user executes can cause the SQL statement cache to grow beyond the size that `STMT_CACHE_SIZE` specifies. When the database server is no longer using an SQL statement within the SQL statement cache, it frees memory in the SQL statement cache until the size reaches a threshold of `STMT_CACHE_SIZE`. However, if thousands of concurrent users are executing several ad hoc queries, the SQL statement cache can grow very large before any statements are removed. In such cases, take one of the following actions:

- Set the `STMT_CACHE_NOLIMIT` configuration parameter to 0 to prevent insertions when the cache size exceeds the value of the `STMT_CACHE_SIZE` parameter.
- Set the `STMT_CACHE_HITS` parameter to a value greater than 0 to prevent caching unshared SQL statements.

You can use one of the following methods to change the `STMT_CACHE_NOLIMIT` configuration parameter value:

- Update the `ONCONFIG` file to specify the `STMT_CACHE_NOLIMIT` configuration parameter. You must restart the database server for the new value to take effect.
- Use the `onmode -W` command to override the `STMT_CACHE_NOLIMIT` configuration parameter dynamically while the database server is running.

```
onmode -W STMT_CACHE_NOLIMIT 0
```

If you restart the database server, the value reverts the value in the `ONCONFIG` file. Therefore, if you want the setting to remain for subsequent restarts, modify the `ONCONFIG` file.

Related reference

 [STMT_CACHE_HITS Configuration Parameter \(Administrator's Reference\)](#)

Multiple SQL statement cache pools

Under some circumstances when the SQL statement cache is enabled, the database server allocates memory from one pool for query structures.

These circumstances are:

- When the database server does not find a matching entry in the cache
- When the database server finds a matching key-only entry in the cache and the hit count reaches the value of the `STMT_CACHE_HITS` configuration parameter

This one pool can become a bottleneck as the number of users increases. The `STMT_CACHE_NUMPOOL` configuration parameter allows you to configure multiple `sscpools`.

You can monitor the pools in the SQL statement cache to determine the following situations:

- The number of SQL statement cache pools is sufficient for your workload.
- The size or limit of the SQL statement cache is not causing excessive memory management.

Related reference

 [STMT_CACHE_NUMPOOL Configuration Parameter \(Administrator's Reference\)](#)

Number of SQL statement cache pools:

When the SQL statement cache (SSC) is enabled, the database server allocates memory from the SSC pool for unlinked SQL statements. The default value for the `STMT_CACHE_NUMPOOL` configuration parameter is 1. As the number of users increases, this one SSC pool might become a bottleneck.

The number of longspins on the SSC pool indicates whether or not the SSC pool is a bottleneck.

Use the **onstat -g spi** option to monitor the number of longspins on an SSC pool. The **onstat -g spi** command displays a list of the resources in the system for which a wait was required before a latch on the resource could be obtained. During the wait, the thread spins (or loops), trying to acquire the resource. The **onstat -g spi** output displays the number of times a wait (**Num Waits** column) was required for the resource and the number of total loops (**Num Loops** column). The **onstat -g spi** output displays only resources that have at least one wait.

Figure 4-8 shows an excerpt of sample output for **onstat -g spi**. Figure 4-8 indicates that no waits occurred for any SSC pool (the **Name** column does not list any SSC pools).

Spin locks with waits:			
Num Waits	Num Loops	Avg Loop/Wait	Name
34477	387761	11.25	mtcb sleeping_lock
312	10205	32.71	mtcb vproc_list_lock

Figure 4-8. **onstat -g spi** output

If you see an excessive number of longspins (**Num Loops** column) on an SSC pool, increase the number of SSC pools in the **STMT_CACHE_NUMPOOL** configuration parameter to improve performance.

Related reference

[STMT_CACHE_NUMPOOL Configuration Parameter \(Administrator's Reference\)](#)

Size of SQL statement cache pools and the current cache:

Use the **onstat -g ssc pool** option to monitor the usage of each SQL statement cache (SSC) pool.

The **onstat -g ssc pool** command displays the size of each pool. The **onstat -g ssc** option displays the cumulative size of the SQL statement cache in the **currsz** column. This current size is the size of memory allocated from the SSC pools by the statements that are inserted into the cache. Because not all statements that allocate memory from the SSC pools are inserted into the cache, the current cache size could be smaller than the total size of the SSC pools. Normally, the total size of all SSC pools does not exceed the **STMT_CACHE_SIZE** value.

Figure 4-9 shows sample output for **onstat -g ssc pool**.

```
onstat -g ssc pool

Pool Summary:
name      class addr      totalsize freesize #allocfrag #freefrag
sscpool0  V      a7e4020  57344    2352     52         7

Blkpool Summary:
name      class addr      size      #blks
```

Figure 4-9. **onstat -g ssc pool** output

The Pool Summary section of the **onstat -g ssc pool** output lists the following information for each pool in the cache.

Column	Description
name	The name of the SQL statement cache (SSC) pool
class	The shared-memory segment type in which the pool has been created. For SSC pools, this value is always "V" for the virtual portion of shared-memory.
addr	The shared-memory address of the SSC pool structure
totalsize	The total size, in bytes, of this SSC pool
freesize	the number of free bytes in this SSC pool
#allocfrag	The number of contiguous areas of memory in this SSC pool that are allocated
#freefrag	The number of contiguous areas of memory that are not used in this SSC pool

The Blkpool Summary section of the **onstat -g ssc pool** output lists the following information for all pools in the cache.

Column	Description
name	The name of the SSC pool
class	The shared-memory segment type in which the pool has been created. For SSC pools, this value is always "V" for the virtual portion of shared-memory.
addr	The shared-memory address of the SSC pool structure
totalsize	The total size, in bytes, of this SSC pool
#blks	The number of 8-kilobyte blocks that make up all the SSC pools

SQL statement cache information in **onstat -g ssc** output

The **onstat -g ssc** command displays summary information for the SQL statement cache.

The **onstat -g ssc** command displays the following information for the SQL statement cache.

*Table 4-4. SQL statement cache information in **onstat -g ssc** output*

Column	Description
#lrus	The number of LRU queues. Multiple LRU queues facilitate concurrent lookup and insertion of cache entries.
currsize	The number of bytes currently allocated to entries in the SQL statement cache
maxsize	The number of bytes specified in the STMT_CACHE_SIZE configuration parameter

Table 4-4. SQL statement cache information in **onstat -g ssc** output (continued)

Column	Description
poolsize	The cumulative number of bytes for all pools in the SQL statement cache. Use the onstat -g ssc pool option to monitor individual pool usage.
#hits	Setting of the STMT_CACHE_HITS configuration parameter, which specifies the number of times that a query is executed before it is inserted into the cache
nolimit	Setting of STMT_CACHE_NOLIMIT configuration parameter

The **onstat -g ssc** command lists the following information for each fully cached entry in the cache. The **onstat -g ssc all** option lists the following information for both the fully cached entries and key-only entries.

Column	Description
lru	The LRU identifier
hash	The hash-bucket identifier
ref_cnt	The number of sessions currently using this statement
hits	The number of times that users read the query from the cache, excluding the first time the statement entered the cache

Column	Description
flags	<p>Shows flag codes.</p> <p>The flag codes for position 1 are:</p> <p>D Indicates that the statement has been dropped</p> <p>A statement in the cache can be dropped (not used any more) when one of its dependencies has changed. For example, when you run UPDATE STATISTICS for the table, the optimizer statistics might change, making the query plan for the SQL statement in the cache obsolete. In this case, the database server marks the statement as dropped the next time that it tries to use it.</p> <p>- Indicates that the statement has not been dropped</p> <p>The flag codes for position 2 are:</p> <p>F Indicates that the cache entry is fully cached and contains the memory structures for the query</p> <p>- Indicates that the statement is not fully cached</p> <p>A statement is not fully cached when the number of times the statement has been executed is less than the value of the STMT_CACHE_HITS configuration parameter. Entries with this - value in the second position appear in the onstat -g ssc all but not in the onstat -g ssc output.</p>
heap_ptr	Pointer to the associated heap for the statement
database	Database against which the SQL statement is executed
user	User executing the SQL statement
statement	Statement text as it would be used to test for a match

UDR cache

The UDR cache stores frequently used UDRs (SPL routines and external routines). The PC_POOLSIZE configuration parameter determines the maximum size of the UDR cache.

Related concepts

“SPL routine executable format stored in UDR cache” on page 10-32

“Changing the UDR cache” on page 10-32

Related reference

 [PC_POOLSIZE Configuration Parameter \(Administrator's Reference\)](#)

Session memory

The database server uses the virtual portion of shared memory mainly for user sessions. The majority of the memory that each user session allocates is for SQL statements. The amount of used memory can vary from one statement to another. You can determine which session and which statements have high memory utilization.

Use the following utility options to determine which session and prepared SQL statements have high memory utilization:

- **onstat -g mem**
- **onstat -g stm**

The **onstat -g mem** option displays memory usage of all sessions. You can find the session that is using the most memory by looking at the **totalsize** and **freesize** output columns. Figure 4-11 shows sample output for **onstat -g mem**. This sample output shows the memory utilization of three user sessions with the values 14, 16, 17 in the **names** output column.

```
onstat -g mem

Pool Summary:
name      class addr      totalsize freesize #allocfrag #freefrag
...
14        V    a974020  45056    11960    99        10
16        V    a9ea020  90112    10608    159       5
17        V    a973020  45056    11304    97        13
...
Blkpool Summary:
name      class addr      size      #blks
mt        V    a235688  798720   19
global    V    a232800  0        0
```

Figure 4-10. *onstat -g mem* output

To display the memory allocated by each prepared statement, use the **onstat -g stm** option. Figure 4-11 shows sample output for **onstat -g stm**.

```
onstat -g stm

session 25 -----
sdblock heapsz statement ('*' = Open cursor)
d36b018 9216 select sum(i) from t where i between -1 and ?
d378018 6240 *select tabname from systables where tabid=7
d36b114 8400 <SPL statement>
```

Figure 4-11. *onstat -g stm* Output

The **heapsz** column in the output in Figure 4-11 on page 4-43 shows the amount of memory used by the statement. An asterisk (*) precedes the statement text if a cursor is open on the statement. The output does not show the individual SQL statements in an SPL routine.

To display the memory for only one session, specify the session ID in the **onstat -g stm** option. For an example, see “Monitor session memory with **onstat -g mem** and **onstat -g stm** output” on page 13-50.

Data-replication buffers and memory utilization

Data replication requires two instances of the database server, a primary one and a secondary one, running on two computers. If you implement data replication for your database server, the database server holds logical-log records in the data-replication buffer before it sends them to the secondary database server.

The data-replication buffer is always the same size as the logical-log buffer.

Memory latches

The database server uses latches to control access to shared memory structures such as the buffer pool or the memory pools for the SQL statement cache. You can obtain statistics on latch use and information about specific latches. These statistics provide a measure of the system activity.

The statistics include the number of times that threads waited to obtain a latch. A large number of latch waits typically results from a high volume of processing activity in which the database server is logging most of the transactions.

Information about specific latches includes a listing of all the latches that are held by a thread and any threads that are waiting for latches. This information allows you to locate any specific resource contentions that exist.

You, as the database administrator, cannot configure or tune the number of latches. However, you can increase the number of memory structures on which the database server places latches to reduce the number of latch waits. For example, you can tune the number of SQL statement cache memory pools or the number of SQL statement cache LRU queues. For more information, see “Multiple SQL statement cache pools” on page 4-38.

Warning: Never stop a database server process that is holding a latch. If you do, the database server immediately initiates an abort.

Monitoring latches with command-line utilities

You can obtain information about latches by running **onstat -p** or **onstat -s**.

Monitoring latches with **onstat -p**

Run **onstat -p** to obtain the values in the field **lchwaits**. This field stores the number of times that a thread was required to wait for a shared-memory latch.

Figure 4-12 on page 4-45 shows an excerpt of sample **onstat -p** output that shows the **lchwaits** field.

```
...
idxa-RA  idx-RA   da-RA   RA-pgsused lchwaits
5         0        204    148        12
...
```

Figure 4-12. `onstat -p` output showing `lchwaits` field

Monitoring latches with `onstat -s`

Run `onstat -s` to obtain general latch information. The output includes the `userthread` column, which lists the address of any user thread that is waiting for a latch.

You can compare this address with the user addresses in the `onstat -u` output to obtain the user-process identification number.

Figure 4-13 shows sample `onstat -s` output.

```
...
Latches with lock or userthread set
name      address  lock wait userthread
LRU1      402e90  0   0      6b29d8
bf[34]    4467c0  0   0      6b29d8
...
```

Figure 4-13. `onstat -s` output

Monitoring latches with ISA

You can monitor latches and spin locks with ISA. ISA uses information generated by `onstat -s` and `onstat -g spi` to display information.

To monitor latches and spin locks with ISA, navigate to the **Performance > Locks** page and click **Latches** or **Spin Locks**.

Click **Refresh** to rerun the commands and display fresh information.

Monitoring latches with SMI tables

You can query the `sysprofile` SMI table to obtain the number of times a thread waited for a latch.

The `latchwts` column of the `sysprofile` table contains the number of times that a thread waited for a latch.

Encrypted values

An encrypted value uses more storage space than the corresponding plain text value because all of the information needed to decrypt the value except the encryption key is stored with the value.

Omitting the hint used with the password can reduce encryption overhead by up to 50 bytes. If you are using encrypted values, you must make sure that you have sufficient space available for the values.

Note: Embedding zero bytes in the encrypted result is not recommended.

Related concepts

 [Column-level encryption \(Security Guide\)](#)

Related reference

 [Calculating storage requirements for encrypted data \(SQL Syntax\)](#)

Chapter 5. Effect of configuration on I/O activity

The configuration of your database server affects I/O activity.

The following factors affect I/O activity:

- The assignment of chunks and dbspaces can create I/O *hot spots*, or disk partitions with a disproportionate amount of I/O activity.
- Your allocation of critical data, sort areas, and areas for temporary files and index builds can place intermittent loads on various disks.
- How you configure read-ahead can increase the effectiveness of individual I/O operations.
- How you configure the background I/O tasks, such as logging and page cleaning, can affect I/O throughput.

Chunk and dbspace configuration

The number of disks that you use and the configuration of your chunks, dbspaces, and blobspaces affect the performance of your database server. You can improve performance by planning disk use and the configuration of chunks, dbspaces, and blobspaces.

All the data that resides in a database is stored on disk. The Optical Subsystem also uses a magnetic disk to access TEXT or BYTE data that is retrieved from optical media. The speed at which the database server can copy the appropriate data pages to and from disk determines how well your application performs.

Disks are typically the slowest component in the I/O path for a transaction or query that runs entirely on one host computer. Network communication can also introduce delays in client/server applications, but these delays are typically outside the control of the database server administrator. For information about actions that the database server administrator can take to improve network communications, see “Network buffer pools” on page 3-16 and “Connections and CPU utilization” on page 3-24.

Disks can become overused or saturated when users request pages too often. Saturation can occur in the following situations:

- You use a disk for multiple purposes, such as for both logging and active database tables.
- Disparate data resides on the same disk.
- Table extents become interleaved.

The various functions that your application requires, as well as the consistency-control functions that the database server performs, determine the optimal disk, chunk, and dbspace layout for your application. The more disks that you make available to the database server, the easier it is to balance I/O across them. For more information about these factors, see Chapter 6, “Table performance considerations,” on page 6-1.

This section outlines important issues for the initial configuration of your chunks, dbspaces, and blobspaces. Consider the following issues when you decide how to lay out chunks and dbspaces on disks:

- Placement and mirroring of critical data
- Load balancing
- Reduction of contention
- Ease of backup and restore

Together with round-robin fragmentation, you can balance chunks over disks and controllers, saving time and handling errors. Placing multiple chunks on a single disk can improve throughput.

Associate disk partitions with chunks

You should assign chunks to entire disk partitions. When a chunk coincides with a disk partition (or device), it is easy to track disk-space use, and you avoid errors caused by miscalculated offsets.

The maximum size for a chunk is 4 terabytes.

Associate dbspaces with chunks

You should associate a single chunk with a dbspace, especially when that dbspace is to be used for a table fragment.

For more information about table placement and layout, see Chapter 6, “Table performance considerations,” on page 6-1.

Placing system catalog tables with database tables

When a disk that contains the system catalog for a particular database fails, the entire database remains inaccessible until the system catalog is restored. Because of this potential inaccessibility, do not cluster the system catalog tables for all databases in a single dbspace. Instead place the system catalog tables with the database tables that they describe.

To create a system catalog table in the table dbspace:

1. Create a database in the dbspace in which the table is to reside.
2. Use the SQL statements DATABASE or CONNECT to make that database the current database.
3. Enter the CREATE TABLE statement to create the table.

I/O for cooked files for dbspace chunks

On UNIX, you can control the use of direct I/O for cooked files used for dbspace chunks.

On UNIX, you can allocate disk space in two ways:

- Use files that are buffered through the operating system. These files are often called *cooked files*.
- Use unbuffered disk access, also called *raw* disk space.

When dbspaces reside on raw disk devices (also called *character-special devices*), the database server uses unbuffered disk access. A raw disk directly transfers data between the database server memory and disk without also copying data.

While you should generally use raw disk devices on UNIX systems to achieve better performance, you might prefer to use cooked files, which are easier to

allocate and manage than raw devices. If you use cooked files, you might be able to get better performance by enabling the Informix direct I/O option.

In addition, Informix supports a separate concurrent I/O option on AIX operating systems. If you enable concurrent I/O on AIX, you get both unbuffered I/O and concurrent I/O. With concurrent I/O, writing to two parts of a file can occur concurrently. (On some other operating systems and file systems, enabling direct I/O also enables concurrent I/O as part of the same file system direct I/O feature.)

To determine the best performance, perform benchmark testing for the dbspace and table layout on your system.

Direct I/O (UNIX)

On UNIX, you can use direct I/O to improve the performance of cooked files. Direct I/O can be beneficial because it avoids file system buffering. Because direct I/O uses unbuffered I/O, it is more efficient for reads and writes that go to disk (as opposed to those reads and writes that merely access the file system buffers).

Direct I/O generally requires data to be aligned on disk sector boundaries.

Direct I/O also allows the use of kernel asynchronous I/O (KAIO), which can further improve performance. By using direct I/O and KAIO where available, the performance of cooked files used for dbspace chunks can approach the performance of raw devices.

If your file system supports direct I/O for the page size used for the dbspace chunk, the database server operates as follows:

- Does not use direct I/O by default.
- Uses direct I/O if the `DIRECT_IO` configuration parameter is set to 1.
- Uses KAIO (if the file system supports it) with direct I/O by default.
- Does not use KAIO with direct I/O if the environment variable `KAIOOFF` is set.

If Informix uses direct I/O for a chunk, and another program tries to open the chunk file without using direct I/O, the open will normally succeed, but there can be a performance penalty. The penalty can occur because the file system attempts to ensure that each open sees the same file data, either by switching to buffered I/O and not using direct I/O for the duration of the conflicting open, or by flushing the file system cache before each direct I/O operation and invalidating the file system cache after each direct write.

Informix does not use direct I/O for temporary dbspaces.

Related reference

 [DIRECT_IO Configuration Parameter \(UNIX\) \(Administrator's Reference\)](#)

Direct I/O (Windows)

Direct I/O is used for dbspace chunks on Windows platforms regardless of the value of the `DIRECT_IO` configuration parameter.

Concurrent I/O (AIX only)

On AIX operating systems, you can use concurrent I/O in addition to direct I/O for chunks that use cooked files. Concurrent I/O can improve performance, because it allows multiple reads and writes to a file to occur concurrently, without the usual serialization of noncompeting read and write operations.

Concurrent I/O can be especially beneficial when you have data in a single chunk file striped across multiple disks.

Concurrent I/O, which you enable by setting the `DIRECT_IO` configuration parameter to 2, includes the benefit of avoiding file system buffering and is subject to the same limitations and use of KAIO as occurs if you use direct I/O without concurrent I/O. Thus, when concurrent I/O is enabled, you get both unbuffered I/O and concurrent I/O.

If Informix uses concurrent I/O for a chunk, and another program (such as an external backup program) tries to open the same chunk file without using concurrent I/O, the open operation will fail.

Informix does not use direct or concurrent I/O for cooked files used for temporary dbspace chunks.

Related reference

[DIRECT_IO Configuration Parameter \(UNIX\) \(Administrator's Reference\)](#)

Enabling the direct I/O or concurrent I/O option (UNIX)

Use the `DIRECT_IO` configuration parameter to enable the direct I/O option on UNIX or the concurrent I/O option on AIX.

Prerequisites:

- You must log on as user **root** or **informix**.
- Direct I/O or concurrent I/O must be available and the file system must support direct I/O for the page size used for the dbspace chunk.

Enable:

- Direct I/O by setting the `DIRECT_IO` configuration parameter to 1.
- Concurrent I/O with direct I/O on AIX operating systems by setting the `DIRECT_IO` configuration parameter to 2.

Specify that you do not want direct I/O or concurrent I/O by setting the `DIRECT_IO` configuration parameter to 0.

Related reference

[DIRECT_IO Configuration Parameter \(UNIX\) \(Administrator's Reference\)](#)



Confirming the use of the direct or concurrent I/O option (UNIX)

You can confirm and monitor the use of direct I/O or concurrent I/O (on AIX) for cooked file chunks.

You can confirm the use of direct I/O or concurrent I/O by:

- Displaying **onstat -d** information.
The **onstat -d** command displays information that includes a flag that identifies whether direct I/O, concurrent I/O (on AIX), or neither is used for cooked file chunks.
- Verifying that the `DIRECT_IO` configuration parameter is set to 1 (for direct I/O) or 2 (for concurrent I/O).

Related reference

-  [DIRECT_IO Configuration Parameter \(UNIX\) \(Administrator's Reference\)](#)
-  [onstat -d command: Print chunk information \(Administrator's Reference\)](#)

Placement of critical data

The disk or disks that contain the system reserved pages, the physical log, and the dbspaces that contain the logical-log files are critical to the operation of the database server. The database server cannot operate if any of these elements becomes unavailable. By default, the database server places all three critical elements in the root dbspace.

To arrive at an appropriate placement strategy for critical data, you must make a trade-off between the availability of data and maximum logging performance.

The database server also places temporary table and sort files in the root dbspace by default. You should use the `DBSPACETEMP` configuration parameter and the `DBSPACETEMP` environment variable to assign these tables and files to other dbspaces. For details, see “Configure dbspaces for temporary tables and sort files” on page 5-8.

Consider separate disks for critical data components

If you place the root dbspace, logical log, and physical log in separate dbspaces on separate disks, you can obtain some distinct performance advantages. The disks that you use for each critical data component should be on separate controllers.

This approach has the following advantages:

- Isolates logging activity from database I/O and allows physical-log I/O requests to be serviced in parallel with logical-log I/O requests
- Reduces the time that you need to recover from a failure

However, unless the disks are mirrored, there is an increased risk that a disk that contains critical data might be affected in the event of a failure, which will bring the database server to a halt and require the complete restoration of all data from a level-0 backup.

- Allows for a relatively small root dbspace that contains only reserved pages, the database partition, and the `sysmaster` database

In many cases, 10,000 kilobytes is sufficient.

The database server uses different methods to configure various portions of critical data. To assign an appropriate dbspace for the root dbspace and physical log, set the appropriate database server configuration parameters. To assign the logical-log files to an appropriate dbspace, use the `onparams` utility.

For more information about the configuration parameters that affect each portion of critical data, see “Configuration parameters that affect critical data” on page 5-8.

Consider mirroring for critical data components

Consider mirroring for the dbspaces that contain critical data. Mirroring these dbspaces ensures that the database server can continue to operate even when a single disk fails.

However, depending on the mix of I/O requests for a given dbspace, a trade-off exists between the fault tolerance of mirroring and I/O performance. You obtain a marked performance advantage when you mirror dbspaces that have a read-intensive usage pattern and a slight performance disadvantage when you mirror write-intensive dbspaces.

Most modern storage devices have excellent mirroring capabilities, and you can use those devices instead of the mirroring capabilities of the database server.

When mirroring is in effect, two disks are available to handle read requests, and the database server can process a higher volume of those requests. However, each write request requires two physical write operations and does not complete until both physical operations are performed. The write operations are performed in parallel, but the request does not complete until the slower of the two disks performs the update. Thus, you experience a slight performance penalty when you mirror write-intensive dbspaces.

Consider mirroring the root dbspace

You can achieve a certain degree of fault tolerance with a minimum performance penalty if you mirror the root dbspace and restrict its contents to read-only or seldom-accessed tables.

When you place update-intensive tables in other, nonmirrored dbspaces, you can use the database server backup-and-restore facilities to perform warm restores of those tables in the event of a disk failure. When the root dbspace is mirrored, the database server remains online to service other transactions while the failed disk is being repaired.

When you mirror the root dbspace, always place the first chunk on a different device than that of the mirror. The MIRRORPATH configuration parameter should have a different value than ROOTPATH.

Related reference

 [MIRRORPATH Configuration Parameter \(Administrator's Reference\)](#)

 [ROOTPATH Configuration Parameter \(Administrator's Reference\)](#)

Consider mirroring smart-large-object chunks

You can achieve higher availability and faster access if you mirror chunks that contain metadata pages.

An sbspace is a logical storage unit composed of one or more chunks that store *smart large objects*, which consist of CLOB (character large object) or BLOB (binary large object) data.

The first chunk of an sbspace contains a special set of pages, called *metadata*, which is used to locate smart large objects in the sbspace. Additional chunks that are added to the sbspace can also have metadata pages if you specify them on the **onspaces** command when you create the chunk.

Consider mirroring chunks that contain metadata pages for the following reasons:

- Higher availability

Without access to the metadata pages, users cannot access any smart large objects in the sbspace. If the first chunk of the sbspace contains all of the metadata pages and the disk that contains that chunk becomes unavailable, you cannot access a smart large object in the sbspace, even if it resides on a chunk on

another disk. For high availability, mirror at least the first chunk of the sbspace and any other chunk that contains metadata pages.

- Faster access

By mirroring the chunk that contains the metadata pages, you can spread read activity across the disks that contain the primary chunk and mirror chunk.

Related concepts

 [Sbspaces \(Administrator's Guide\)](#)

Mirroring and its effect on the logical log

The logical log is write intensive. If the dbspace that contains the logical-log files is mirrored, you encounter a slight double-write performance penalty. However, you can adjust the rate at which logging generates I/O requests to a certain extent by choosing an appropriate log buffer size and logging mode.

For details on the slight double-write performance penalty, see “Consider mirroring for critical data components” on page 5-5.

With unbuffered and ANSI-compliant logging, the database server requests a flush of the log buffer to disk for every committed transaction (two when the dbspace is mirrored). Buffered logging generates far fewer I/O requests than unbuffered or ANSI-compliant logging.

With buffered logging, the log buffer is written to disk only when it fills and all the transactions that it contains are completed. You can reduce the frequency of logical-log I/O even more if you increase the size of your logical-log buffers. However, buffered logging leaves transactions in any partially filled buffers vulnerable to loss in the event of a system failure.

Although database consistency is guaranteed under buffered logging, specific transactions are not guaranteed against a failure. The larger the logical-log buffers, the more transactions you might need to reenter when service is restored after a failure.

Unlike the physical log, you cannot specify an alternative dbspace for logical-log files in your initial database server configuration. Instead, use the **onparams** utility first to add logical-log files to an alternative dbspace and then drop logical-log files from the root dbspace.

Related reference

 [The onparams Utility \(Administrator's Reference\)](#)

Mirroring and its effect on the physical log

The physical log is write intensive, with activity occurring at checkpoints and when buffered data pages are flushed. I/O to the physical log also occurs when a page-cleaner thread is activated. If the dbspace that contains the physical log is mirrored, you encounter a slight double-write performance penalty.

For details on the slight double-write performance penalty, see “Consider mirroring for critical data components” on page 5-5.

To keep I/O to the physical log at a minimum, you can adjust the checkpoint interval and the LRU minimum and maximum thresholds. (See “CKPTINTVL and its effect on checkpoints” on page 5-31 and “BUFFERPOOL and its effect on page cleaning” on page 5-41.)

Configuration parameters that affect critical data

The configuration parameters that configure the root dbspace and the logical and physical logs affect critical data.

You can use the following configuration parameters to configure the root dbspace:

- ROOTNAME
- ROOTOFFSET
- ROOTPATH
- ROOTSIZE
- MIRROR
- MIRRORPATH
- MIRROROFFSET

These parameters determine the location and size of the initial chunk of the root dbspace and configure mirroring, if any, for that chunk. (If the initial chunk is mirrored, all other chunks in the root dbspace must also be mirrored). Otherwise, these parameters have no major impact on performance.

The following configuration parameters affect the logical logs:

- LOGSIZE
- LOGBUFF

LOGSIZE determines the size of each logical-log files. LOGBUFF determines the size of the three logical-log buffers that are in shared memory. For more information about LOGBUFF, see “The LOGBUFF configuration parameter and memory utilization” on page 4-16.

The following configuration parameters determine the location and size of the physical log:

- PHYSDBS
- PHYSFILE

Configure dbspaces for temporary tables and sort files

Applications that use temporary tables or large sort operations require a large amount of temporary space. To improve performance of these applications, use the DBSPACETEMP configuration parameter or the **DBSPACETEMP** environment variable to designate one or more dbspaces for temporary tables and sort files.

Depending on how the temporary space is created, the database server uses the following default locations for temporary table and sort files when you do not set DBSPACETEMP:

- The dbspace of the current database, when you create an explicit temporary table with the TEMP TABLE clause of the CREATE TABLE statement and do not specify a dbspace for the table either in the IN dbspace clause or in the FRAGMENT BY clause

This action can severely affect I/O to that dbspace. If the root dbspace is mirrored, you encounter a slight double-write performance penalty for I/O to the temporary tables and sort files.

- The root dbspace when you create an explicit temporary table with the INTO TEMP option of the SELECT statement

This action can severely affect I/O to the root dbspace. If the root dbspace is mirrored, you encounter a slight double-write performance penalty for I/O to the temporary tables and sort files.

- The operating-system directory or file that you specify in one of the following variables:
 - In UNIX, the operating-system directory or directories that the **PSORT_DBTEMP** environment variable specifies, if it is set
 - If **PSORT_DBTEMP** is not set, the database server writes sort files to the operating-system file space in the **/tmp** directory.
 - In Windows, the directory specified in **TEMP** or **TMP** in the User Environment Variables window on **Control Panel > System**.

The database server uses the operating-system directory or files to direct any overflow that results from the following database operations:

- SELECT statement with GROUP BY clause
- SELECT statement with ORDER BY clause
- Hash-join operation
- Nested-loop join operation
- Index builds

Warning: If you do not specify a value for the **DBSPACETEMP** configuration parameter or the **DBSPACETEMP** environment variable, the database server uses this operating-system file for implicit temporary tables. If this file system has insufficient space to hold a sort file, the query performing the sort returns an error. Meanwhile, the operating system might be severely impacted until you remove the sort file.

You can improve performance with the use of temporary dbspaces that you create exclusively to store temporary tables and sort files. You should use the **DBSPACETEMP** configuration parameter and the **DBSPACETEMP** environment variable to assign these tables and files to temporary dbspaces.

When you specify dbspaces in either the **DBSPACETEMP** configuration parameter or the **DBSPACETEMP** environment variable, you gain the following performance advantages:

- Reduced I/O impact on the root dbspace, production dbspaces, or operating-system files
- Use of parallel sorts into the temporary files (to process query clauses such as ORDER BY or GROUP BY, or to sort index keys when you execute CREATE INDEX) when you specify more than one dbspace for temporary tables and PDQ priority is set to greater than 0.
- Improved speed with which the database server creates temporary tables when you assign two or more temporary dbspaces on separate disks
- Use of parallel inserts into the temporary table when PDQ priority is set to greater than 0 and the temporary table is created with one of the following specifications that the following table shows.

The database server automatically applies its parallel insert capability to fragment the temporary table across those dbspaces, using a round-robin distribution scheme.

Statement That Creates Temporary Table	Database Logged	WITH NO LOG clause	FRAGMENT BY clause	Where Temp Table Created
CREATE TEMP TABLE	Yes	No	No	Root dbspace
CREATE TEMP TABLE	Yes	Yes	No	One of dbspaces specified in DBSPACETEMP
CREATE TEMP TABLE	Yes	No	Yes	Cannot create temp table. Error 229/196

Important: It is recommended that you use the DBSPACETEMP parameter or the DBSPACETEMP environment variable for better performance of sort operations and to prevent the database server from unexpectedly filling file systems. The dbspaces that you list must be composed of chunks that are allocated as unbuffered devices.

Related reference

[➡ DBSPACETEMP Configuration Parameter \(Administrator's Reference\)](#)

Creating temporary dbspaces

You can create a dbspace for the exclusive use of temporary tables and sort files. The database server does not perform logical or physical logging of temporary dbspaces, and temporary dbspaces are never backed up as part of a full-system backup.

To create a dbspace for the exclusive use of temporary tables and sort files, use **onspaces -t**. For best performance, use the following guidelines:

- If you create more than one temporary dbspace, create each dbspace on a separate disk to balance the I/O impact.
- Place no more than one temporary dbspace on a single disk.

You cannot mirror a temporary dbspace that you create with **onspaces -t**.

Important: In the case of a database with logging, you must include the WITH NO LOG clause in the SELECT... INTO TEMP statement to place the explicit temporary tables in the dbspaces listed in the DBSPACETEMP configuration parameter and the DBSPACETEMP environment variable. Otherwise, the database server stores the explicit temporary tables in the root dbspace.

Related reference

[➡ DBSPACETEMP Configuration Parameter \(Administrator's Reference\)](#)

[➡ create tempdbspace argument: Create a temporary dbspace \(SQL administration API\) \(Administrator's Reference\)](#)

[➡ onspaces -c -d: Create a dbspace \(Administrator's Reference\)](#)

Specify temporary tables in the DBSPACETEMP configuration parameter

The DBSPACETEMP configuration parameter specifies a list of dbspaces in which the database server places temporary tables and sort files by default. Some or all of the dbspaces that you list in this configuration parameter can be temporary dbspaces, which are reserved exclusively to store temporary tables and sort files.

If you specify more than one dbspace in this list, the database server uses its parallel insert capability to fragment temporary tables across all the listed dbspaces, using a round-robin distribution scheme. For more information, see “Distribution schemes” on page 9-6.

The DBSPACETEMP configuration parameter lets the database administrator restrict which dbspaces the database server uses for temporary storage.

Important: The DBSPACETEMP configuration parameter is not set in the `onconfig.std` file. For best performance with temporary tables and sort files, you should use DBSPACETEMP to specify two or more dbspaces on separate disks.

Related reference

 [DBSPACETEMP Configuration Parameter \(Administrator's Reference\)](#)

Override the DBSPACETEMP configuration parameter for a session

To override the DBSPACETEMP configuration parameter, you can use the **DBSPACETEMP** environment variable for both temporary tables and sort files. This environment variable specifies a comma- or colon-separated list of dbspaces in which to place temporary tables for the current session.

Important: Use the DBSPACETEMP configuration parameter or the **DBSPACETEMP** environment variable for better performance of sort operations and to prevent the database server from unexpectedly filling file systems.

You should use DBSPACETEMP rather than the **PSORT_DBTEMP** environment variable to specify sort files for the following reasons:

- **DBSPACETEMP** typically yields better performance.
When dbspaces reside on character-special devices (also known as raw disk devices), the database server uses unbuffered disk access. I/O is faster to unbuffered devices than to regular (buffered) operating-system files because the database server manages the I/O operation directly.
- **PSORT_DBTEMP** specifies one or more operating-system directories in which to place sort files.
These operating-system files can unexpectedly fill on your computer because the database server does not manage them.

Estimating temporary space for dbspaces and hash joins

You can estimate and increase the amount of temporary space for dbspaces and for hash joins. If you do this, you can prevent the possible overflow of memory to temporary space on disk.

You can use the following guidelines to estimate the amount of temporary space to allocate:

- For OLTP applications, allocate temporary dbspaces that equal at least 10 percent of the table.
- For DSS applications, allocate temporary dbspaces that equal at least 50 percent of the table.

A hash join, which works by building a table (the hash table) from the rows in one of the tables in a join, and then probing it with rows from the other table, can use a significant amount of memory and can potentially overflow to temporary space

on disk. The hash table size is governed by the size of the table used to build the hash table (which is often the smaller of the two tables in the join), after applying any filters, which can reduce the number of rows and possibly reduce the number of columns.

Hash-join partitions are organized into pages. Each page has a header. The header and tuples are larger in databases on 64-bit platforms than in builds on 32-bit platforms. The size of each page is the base page size (2K or 4K depending on system) unless a single row needs more space. If you need more space, you can add bytes to the length of your rows.

You can use the following formula to estimate the amount of memory that is required for the hash table in a hash join:

```
hash_table_size = (32 bytes + row_size_smalltab) * num_rows_smalltab
```

where `row_size_smalltab` and `num_rows_smalltab` refer to the row size and the number of rows, respectively, in the smaller of the two tables participating in the hash join.

For example, suppose you have a page head that is 80 bytes in length and a row header that is 48 bytes in length. Because each row must be aligned to 8 bytes, you might need to add up to 7 bytes to the row length, as shown in these formulas:

```
per_row_size = 48 bytes + row_size + mod(row_size, 8)
page_size = base_page_size (2K or 4K)
rows_per_page = round_down_to_integer((page_size - 80 bytes) / per_row_size)
```

If the value of `rows_per_page` is less than one, increase the `page_size` value to the smallest multiple of the `base_page_size`, as shown in this formula:

```
size = (numrows_smalltab / rows_per_page) * page_size
```

You can use the `DS_NONPDQ_QUERY_MEM` configuration parameter to configure sort memory for all queries except PDQ queries.

For more information, see “Hash join” on page 10-3 and “More memory for queries with hash joins, aggregates, and other memory-intensive elements” on page 13-33.

Related reference

[DS_NONPDQ_QUERY_MEM Configuration Parameter \(Administrator's Reference\)](#)

PSORT_NPROCS environment variable

The `PSORT_NPROCS` environment variable specifies the maximum number of threads that the database server can use to sort a query. When a query involves a large sort operation, multiple sort threads can execute in parallel to improve the performance of the query.

When the value of PDQ priority is 0 and `PSORT_NPROCS` is greater than 1, the database server uses parallel sorts. The management of PDQ does not limit these sorts. In other words, although the sort is executed in parallel, the database server does not regard sorting as a PDQ activity. When PDQ priority is 0, the database server does not control sorting by any of the PDQ configuration parameters.

When PDQ priority is greater than 0 and `PSORT_NPROCS` is greater than 1, the query benefits both from parallel sorts and from PDQ features such as parallel

scans and additional memory. Users can use the **PDQPRIORITY** environment variable to request a specific proportion of PDQ resources for a query. You can use the **MAX_PDQPRIORITY** parameter to limit the number of such user requests. For more information about **MAX_PDQPRIORITY**, see “Limiting PDQ resources in queries” on page 3-11.

The database server allocates a relatively small amount of memory for sorting, and that memory is divided among the **PSORT_NPROCS** sort threads. Sort processes use temporary space on disk when not enough memory is allocated. For more information about memory allocated for sorting, see “Estimating memory needed for sorting” on page 7-14.

Important: For better performance for a sort operation, set **PSORT_NPROCS** initially to 2 if your computer has multiple CPUs. If the subsequent CPU activity is lower than I/O activity, you can increase the value of **PSORT_NPROCS**.

For more information about sorts during index builds, see “Improving performance for index builds” on page 7-13.

Configure sbspaces for temporary smart large objects

Applications can use temporary smart large objects for text, image, or other user-defined data types that are only required during the life of the user session. These applications do not require logging of the temporary smart large objects. Logging adds I/O activity to the logical log and increases memory utilization.

You can store temporary smart large objects in a permanent sbspace or a temporary sbspace.

- Permanent sbspaces

If you store the temporary smart large objects in a regular sbspace and keep the default no logging attribute, changes to the objects are not logged, but the metadata is always logged.

- Temporary sbspaces

Applications that update temporary smart large objects stored in temporary sbspaces are significantly faster because the database server does not log the metadata or the user data in a temporary sbspace.

To improve performance of applications that update temporary smart large objects, specify the **LOTEMP** flag in the **mi_lo_specset_flags** or **ifx_lo_specset_flags** API function and specify a temporary sbspace for the temporary smart large objects. The database server uses the following order of precedence for locations to place temporary smart large objects:

- The sbspace you specify in the **mi_lo_specset_sbspace** or **ifx_lo_specset_sbspace** API function when you create the smart large object

Specify a temporary sbspace in the API function so that changes to the objects and the metadata are not logged. The sbspace you specify in the API function overrides any default sbspaces that the **SBSPACETEMP** or **SBSPACENAME** configuration parameters might specify.

- The sbspace you specify in the **IN Sbspace** clause when you create an explicit temporary table with the **TEMP TABLE** clause of the **CREATE TABLE** statement

Specify a temporary sbspace in the **IN Sbspace** clause so that changes to the objects and the metadata are not logged.

- The permanent sbspace you specify in the SBSPACENAME configuration parameter, if you do not specify an sbspace in the SBSPACETEMP configuration parameter

If no temporary sbspace is specified in any of the above methods, then the database server issues the following error message when you try to create a temporary smart large object:

-12053 Smart Large Objects: No sbspace number specified.

Creating temporary sbspaces

To create an sbspace for the exclusive use of temporary smart large objects, use **onspaces -c -S** with the **-t** option.

For best performance, use the following guidelines:

- If you create more than one temporary sbspace, create each sbspace on a separate disk to balance the I/O impact.
- Place no more than one temporary sbspace on a single disk.

The database server does not perform logical or physical logging of temporary sbspaces, and temporary sbspaces are never backed up as part of a full-system backup. You cannot mirror a temporary sbspace that you create with **onspaces -t**.

Important: In the case of a database with logging, you must include the WITH NO LOG clause in the SELECT... INTO TEMP statement to place the temporary smart large objects in the sbspaces listed in the SBSPACETEMP configuration parameter. Otherwise, the database server stores the temporary smart large objects in the sbspace listed in the SBSPACENAME configuration parameter.

Related tasks

[Creating a temporary sbspace \(Administrator's Guide\)](#)

Related reference

[onspaces -c -S: Create an sbspace \(Administrator's Reference\)](#)

SBSPACETEMP configuration parameter

The SBSPACETEMP configuration parameter specifies a list of sbspaces in which the database server places temporary smart large objects by default. Some or all of the sbspaces that you list in this configuration parameter can be temporary sbspaces, which are reserved exclusively to store temporary smart large objects.

The SBSPACETEMP configuration parameter lets the database administrator restrict which sbspaces the database server uses for temporary storage. .

Important: The SBSPACETEMP configuration parameter is not set in the **onconfig.std** file. For best performance with temporary smart large objects, use SBSPACETEMP to specify two or more sbspaces on separate disks.

Related reference

[SBSPACETEMP Configuration Parameter \(Administrator's Reference\)](#)

Placement of simple large objects

You can store simple large objects in either the same dbspace in which the table resides or in a blobspace.

A blob space is a logical storage unit composed of one or more chunks that store only simple large objects (TEXT or BYTE data). For information about blob spaces, which store smart large objects (such as BLOB, CLOB, or multirepresentational data), see “Factors that affect I/O for smart large objects” on page 5-19.

If you use a blob space, you can store simple large objects on a separate disk from the table with which the data is associated. You can store simple large objects associated with different tables in the same blob space.

You can create a blob space with the following utilities:

- ON-Monitor (UNIX only)
- **ISA**
- **onspaces**

You assign simple large objects to a blob space when you create the tables with which simple large objects are associated, using the CREATE TABLE statement.

Simple large objects are not logged and do not pass through the buffer pool. However, frequency of checkpoints can affect applications that access TEXT or BYTE data. For more information, see “LOGSIZE and LOGFILES and their effect on checkpoints” on page 5-32.

Related reference

 [CREATE TABLE statement \(SQL Syntax\)](#)

Advantage of blob spaces over dbspaces

If you store simple large objects in a blob space on a separate disk from the table with which it is associated, instead of storing the objects in a db space, you can obtain some performance advantages.

The performance advantages of storing simple large objects in a blob space are:

- You have parallel access to the table and simple large objects.
- Unlike simple large objects stored in a db space, blob space data is written directly to disk. Simple large objects do not pass through resident shared memory, which leaves memory pages free for other uses.
- Simple large objects are not logged, which reduces logging I/O activity for logged databases.

For more information, see “Storing simple large objects in the tblspace or a separate blob space” on page 6-8.

Blobpage size considerations

Blob spaces are divided into units called *blobpages*. The database server retrieves simple large objects from a blob space in blobpage-sized units. You specify the size of a blobpage in multiples of a disk page when you create the blob space.

The optimal blobpage size for your configuration depends on the following factors:

- The size distribution of the simple large objects
- The trade-off between retrieval speed for your largest simple large object and the amount of disk space that is wasted by storing simple large objects in large blobpages

To retrieve simple large objects as quickly as possible, use the size of your largest simple large object rounded up to the nearest disk-page-sized increment. This scheme guarantees that the database server can retrieve even the largest simple large object in a single I/O request. Although this scheme guarantees the fastest retrieval, it has the potential to waste disk space. Because simple large objects are stored in their own blobpage (or set of blobpages), the database server reserves the same amount of disk space for every blobpage even if the simple large object takes up a fraction of that page. Using a smaller blobpage allows you to make better use of your disk, especially when large differences exist in the sizes of your simple large objects.

To achieve the greatest theoretical utilization of space on your disk, you can make your blobpage the same size as a standard disk page. Then many, if not most, simple large objects would require several blobpages. Because the database server acquires a lock and issues a separate I/O request for each blobpage, this scheme performs poorly.

In practice, a balanced scheme for sizing uses the most frequently occurring simple-large-object size as the size of a blobpage. For example, suppose that you have 160 simple-large-object values in a table with the following size distribution:

- Of these values, 120 are 12 kilobytes each.
- The other 40 values are 16 kilobytes each.

You can choose one of the following blobpage sizes:

- The 12-kilobyte blobpage size provides greater storage efficiency than a 16-kilobyte blobpage size, as the following two calculations show:

- 12 kilobytes

This configuration allows the majority of simple-large-object values to require a single blobpage and the other 40 values to require two blobpages. In this configuration, 8 kilobytes is wasted in the second blobpage for each of the larger values. The total wasted space is as follows:

$$\begin{aligned}\text{wasted-space} &= 8 \text{ kilobytes} * 40 \\ &= 320 \text{ kilobytes}\end{aligned}$$

- 16 kilobytes

In this configuration, 4 kilobytes is wasted in the extents of 120 simple large objects. The total wasted space is as follows:

$$\begin{aligned}\text{wasted-space} &= 4 \text{ kilobytes} * 120 \\ &= 480 \text{ kilobytes}\end{aligned}$$

- If your applications access the 16-kilobyte simple-large-object values more frequently, the database server must perform a separate I/O operation for each blobpage. In this case, the 16-kilobyte blobpage size provides better retrieval speed than a 12-kilobyte blobpage size.

Tip: If a table has more than one *simple-large-object column and the data values are not close in size*, store the data in different blobspaces, each with an appropriately sized blobpage.

Optimize blobspace blobpage size

When you are evaluating blobspace storage strategy, you can measure efficiency by two criteria: blobpage fullness and the blobpages required per simple large object.

Blobpage fullness refers to the amount of data within each blobpage. TEXT and BYTE data stored in a blobpage cannot share blobpages. Therefore, if a single simple large object requires only 20 percent of a blobpage, the remaining 80 percent of the page is unavailable for use.

However, avoid making the blobpages too small. When several blobpages are needed to store each simple large object, you increase the overhead cost of storage. For example, more locks are required for updates, because a lock must be acquired for each blobpage.

Obtain blobspace storage statistics

To help you determine the optimal blobpage size for each blobspace, use the **oncheck -pB** command.

The command lists the following statistics for each table (or database):

- The number of blobpages used by the table (or database) in each blobspace
- The average fullness of the blobpages used by each simple large object stored as part of the table (or database)

Determine blobpage fullness with oncheck -pB output

The **oncheck -pB** command displays statistics that describe the average fullness of blobpages. These statistics provide a measure of storage efficiency for individual simple large objects in a database or table.

If you find that the statistics for a significant number of simple large objects show a low percentage of fullness, the database server might benefit from changing the size of the blobpage in the blobspace.

Both the **oncheck -pB** and **onstat -d update** commands display the same information about the number of free blobpages. The **onstat -d update** command displays the same information as **onstat -d** and an accurate number of free blobpages for each blobspace chunk.

Execute **oncheck -pB** with either a database name or a table name as a parameter. The following example retrieves storage information for all simple large objects stored in the table **sriram.catalog** in the **stores_demo** database:

```
oncheck -pB stores_demo:sriram.catalog
```

oncheck -pB Output

Figure 5-1 shows the output of this command.

BLOBSpace Report for stores_demo:sriram.catalog						
Total pages used by table						7
BLOBSpace usage:						
Space Name	Page Number	Pages	Percent Full			
			0-25%	26-50%	51-75	76-100%

blobPIC 0x300080	1		x			
blobPIC 0x300082	2			x		

Page Size is 6144		3				
bsp1 0x2000b2	2			x		
bsp1 0x2000b6	2				x	

Page Size is 2048		4				

Figure 5-1. Output of **oncheck -pB**

Space Name is the name of the blob space that contains one or more simple large objects stored as part of the table (or database).

Page Number is the starting address in the blob space of a specific simple large object.

Pages is the number of the database server pages required to store this simple large object.

Percent Full is a measure of the average blob page fullness, by blob space, for each blob space in this table or database.

Page Size is the size in bytes of the blob page for this blob space. Blob page size is always a multiple of the database server page size.

The example output indicates that four simple large objects are stored as part of the table **sriram.catalog**. Two objects are stored in the blob space **blobPIC** in 6144-byte blob pages. Two more objects are stored in the blob space **bspc1** in 2048-byte blob pages.

The summary information that appears at the top of the display, **Total pages used by table** is a simple total of the blob pages needed to store simple large objects. The total says nothing about the size of the blob pages used, the number of simple large objects stored, or the total number of bytes stored.

The efficiency information displayed under the **Percent Full** heading is imprecise, but it can alert an administrator to trends in the storage of TEXT and BYTE data.

Interpreting blob page average fullness:

You can analyze the output of the **oncheck -pB** command to calculate average fullness.

The first simple large object listed in Figure 5-1 on page 5-17 is stored in the blob space **blobPIC** and requires one 6144-byte blob page. The blob page is 51 to 75 percent full, meaning that the size is between $0.51 * 6144 = 3133$ bytes and $0.75 * 6144 = 4608$. The maximum size of this simple large object must be less than or equal to 75 percent of 6144 bytes, or 4608 bytes.

The second object listed under blob space **blobPIC** requires two 6144-byte blob pages for storage, or a total of 12,288 bytes. The average fullness of all allocated blob pages is 51 to 75 percent. Therefore, the minimum size of the object must be greater than 50 percent of 12,288 bytes, or 6144 bytes. The maximum size of the simple large object must be less than or equal to 75 percent of 12,288 bytes, or 9216 bytes. The average fullness does not mean that each page is 51 to 75 percent full. A calculation would yield 51 to 75 percent average fullness for two blob pages where the first blob page is 100 percent full and the second blob page is 2 to 50 percent full.

Now consider the two simple large objects in blob space **bspc1**. These two objects appear to be nearly the same size. Both objects require two 2048-byte blob pages, and the average fullness for each is 76 to 100 percent. The minimum size for these simple large objects must be greater than 75 percent of the allocated blob pages, or 3072 bytes. The maximum size for each object is slightly less than 4096 bytes (allowing for overhead).

Analyzing efficiency criteria with oncheck -pB output:

You can analyze the output of the **oncheck -pB** command to determine if there is a more efficient storage strategy.

Looking at the efficiency information for that is shown for blobspace **bspc1** in Figure 5-1 on page 5-17, a database server administrator might decide that a better storage strategy for TEXT and BYTE data would be to double the blobpage size from 2048 bytes to 4096 bytes. (Blobpage size is always a multiple of the database server page size.) If the database server administrator made this change, the measure of page fullness would remain the same, but the number of locks needed during an update of a simple large object would be reduced by half.

The efficiency information for blobspace **blobPIC** reveals no obvious suggestion for improvement. The two simple large objects in **blobPIC** differ considerably in size, and there is no optimal storage strategy. In general, simple large objects of similar size can be stored more efficiently than simple large objects of different sizes.

Factors that affect I/O for smart large objects

An sbspace is a logical storage unit, composed of one or more chunks, in which you can store smart large objects (such as BLOB, CLOB, or multi representational data). Disk layout for sbspaces, the settings of certain configuration parameters, and some **onspaces** utility options affect I/O for smart large objects.

The DataBlade API and the Informix ESQL/C application programming interface also provide functions that affect I/O operations for smart large objects.

Important: For most applications, you should use the values that the database server calculates for the disk-storage information. For more information, see the *IBM Informix ESQL/C Programmer's Manual* and the *IBM Informix DataBlade API Programmer's Guide*.

Related concepts

 [Sbspaces \(Administrator's Guide\)](#)

Disk layout for sbspaces

You create sbspaces on separate disks from the table with which the data is associated. You can store smart large objects associated with different tables within the same sbspace. When you store smart large objects in an sbspace on a separate disk from the table with which it is associated, the database server provides some performance advantages.

These performance advantages are:

- You have parallel access to the table and smart large objects.
- When you choose not to log the data in an sbspace, you reduce logging I/O activity for logged databases.

To create an sbspace, use the **onspaces** utility. You assign smart large objects to an sbspace when you use the CREATE TABLE statement to create the tables with which the smart large objects are associated.

Related reference

- [📄 onspaces -c -S: Create an sbspace \(Administrator's Reference\)](#)
- [📄 CREATE TABLE statement \(SQL Syntax\)](#)

Configuration parameters that affect sbspace I/O

The SBSPACENAME, BUFFERPOOL, and LOGBUFF configuration parameters affect the I/O performance of sbspaces.

The SBSPACENAME configuration parameter indicates the default sbspace name if you do not specify the sbspace name when you define a column of data type CLOB or BLOB. To reduce disk contention and provide better load balancing, place the default sbspace on a separate disk from the table data.

The BUFFERPOOL configuration parameter specifies the default values for buffers and LRU queues in a buffer pool for both the default page size buffer pool and for any non-default pages size buffer pools. The size of your memory buffer pool affects I/O operations for smart large objects because the buffer pool is the default area of shared memory for these objects. If your applications frequently access smart large objects, it is advantageous to have these objects in the buffer pool. Smart large objects only use the default page size buffer pool. For information about estimating the amount to increase your buffer pool for smart large objects, see “Smart large objects and buffers” on page 4-13.

By default, the database server reads smart large objects into the buffers in the resident portion of shared memory. For more information on using lightweight I/O buffers, see “Lightweight I/O for smart large objects” on page 5-22.

The LOGBUFF configuration parameter affects logging I/O activity because it specifies the size of the logical-log buffers that are in shared memory. The size of these buffers determines how quickly they fill and therefore how often they need to be flushed to disk.

If you log smart-large-object user data, increase the size of your logical-log buffer to prevent frequent flushing to these log files on disk.

Related reference

- [📄 SBSPACENAME Configuration Parameter \(Administrator's Reference\)](#)
- [📄 BUFFERPOOL configuration parameter \(Administrator's Reference\)](#)
- [📄 LOGBUFF Configuration Parameter \(Administrator's Reference\)](#)

onspaces options that affect sbspace I/O

When you create an sbspace with the **onspaces** utility, you specify information that affects I/O performance. This information includes the size of extents, the buffering mode (and whether you want the server to use lightweight I/O), and logging.

Sbspace extents

As you add smart large objects to a table, the database server allocates disk space to the sbspace in units called *extents*. Each extent is a block of physically contiguous pages from the sbspace.

Even when the sbspace includes more than one chunk, each extent is allocated entirely within a single chunk so that it remains contiguous. Contiguity is important to I/O performance.

When the pages of data are contiguous, disk-arm motion is minimized when the database server reads the rows sequentially. The mechanism of extents is a compromise between the following competing requirements:

- The size of some smart large objects is not known in advance.
- The number of smart large objects in different tables can grow at different times and different rates.
- All the pages of a single smart large object should ideally be adjacent for best performance when you retrieve the entire object.

Because you might not be able to predict the number and size of smart large objects, you cannot specify the extent length of smart large objects. Therefore, the database server adds extents only as they are needed, but all the pages in any one extent are contiguous for better performance. In addition, when the database server creates a new extent that is adjacent to the previous extent, it treats both extents as a single extent.

The number of pages in an sbspace extent is determined by one of the following methods:

- The database server calculates the extent size for a smart large object from a set of heuristics, such as the number of bytes in a write operation. For example, if an operation asks to write 30 kilobytes, the database server tries to allocate an extent the size of 30 kilobytes.
- The final size of the smart large object as indicated by one of the following functions when you open the sbspace in an application program:
 - For *DB-Access*: the DataBlade API **mi_lo_specset_estbytes** function. For more information about the DataBlade API functions to open a smart large object and set the estimated number of bytes, see the *IBM Informix DataBlade API Programmer's Guide*.
 - For *ESQL/C*: the Informix ESQL/C **ifx_lo_specset_estbytes** function. For more information about the Informix ESQL/C functions to open a smart large object and set the estimated number of bytes, see the *IBM Informix ESQL/C Programmer's Manual*.

These functions are the best way to set the extent size because they reduce the number of extents in a smart large object. The database server tries to allocate the entire smart large object as one extent (if an extent of that size is available in the chunk).

- The **EXTENT_SIZE** flag in the **-Df** option of the **onspaces** command when you create or alter the sbspace

Most administrators do not use the **onspaces** **EXTENT_SIZE** flag because the database server calculates the extent size from heuristics. However, you might consider using the **onspaces** **EXTENT_SIZE** flag in the following situations:

- Many one-page extents are scattered throughout the sbspace.
- Almost all smart large objects are the same length.
- The **EXTENT SIZE** keyword of the **CREATE TABLE** statement when you define the **CLOB** or **BLOB** column

Most administrators do not use the **EXTENT SIZE** keyword when they create or alter a table because the database server calculates the extent size from

heuristics. However, you might consider using this EXTENT SIZE keyword if almost all smart large objects are the same length.

Important: For most applications, you should use the values that the database server calculates for the extent size. Do not use the DataBlade API `mi_lo_specset_extsz` function or the Informix ESQL/C `ifx_lo_specset_extsz` function to set the extent size of the smart large object.

If you know the size of the smart large object, it is recommended that you specify the size in the DataBlade API `mi_lo_specset_estbytes()` function or Informix ESQL/C `ifx_lo_specset_estbytes()` function instead of in the `onspaces` utility or the CREATE TABLE or the ALTER TABLE statement. These functions are the best way to set the extent size because the database server allocates the entire smart large object as one extent (if it has contiguous storage in the chunk).

Extent sizes over one megabyte do not provide much I/O benefit because the database server performs read and write operations in multiples of 60 kilobytes at the most. However, the database server registers each extent for a smart large object in the metadata area; therefore, especially large smart large objects might have many extent entries. Performance of the database server might degrade when it accesses these extent entries. In this case, you can reduce the number of extent entries in the metadata area if you specify the eventual size of the smart large object in the `mi_lo_specset_estbytes()` function or `ifx_lo_specset_estbytes()` function.

For more information, see “Improving metadata I/O for smart large objects” on page 6-12.

Lightweight I/O for smart large objects

Instead of using the buffer pool, the administrator and programmer have the option to use *lightweight I/O*. Lightweight I/O operations use private buffers in the session pool of the virtual portion of shared memory.

By default, smart large objects pass through the buffer pool in the resident portion of shared memory. Although smart large objects have lower priority than other data, the buffer pool can become full when an application accesses many smart large objects. A single application can fill the buffer pool with smart large objects and leave little room for data that other applications might need. In addition, when the database server performs scans of many pages into the buffer pool, the overhead and contention associated with checking individual pages in and out might become a bottleneck.

Important: Use private buffers only when you read or write smart large objects in read or write operations greater than 8080 bytes and you seldom access them. That is, if you have infrequent read or write function calls that read large amounts of data in a single function invocation, lightweight I/O can improve I/O performance.

Advantages of lightweight I/O for smart large objects:

Lightweight I/O provides some performance advantages, because the database server is not using the buffer pool.

Lightweight I/O provides the following advantages:

- Transfers larger blocks of data in one I/O operation

These I/O blocks can be as large as 60 kilobytes. But the bytes must be adjacent for the database server to transfer them in a single I/O operation.

- Bypasses the overhead of the buffer pool when many pages are read
- Prevents frequently accessed pages from being forced out of the buffer pool when many sequential pages are read for smart large objects

When you use lightweight I/O buffers for smart large objects, the database server might read several pages with one I/O operation. A single I/O operation reads in several smart-large-object pages, up to the size of an extent. For information about when to specify extent size, see “Sbospace extents” on page 5-20.

Specifying lightweight I/O for smart large objects:

To specify the use of lightweight I/O when creating the sbospace, use the BUFFERING tag of the **-Df** option in the **onspaces -c -S** command.

The default value for BUFFERING is 0N, which means to use the buffer pool. The buffering mode that you specify (or the default, if you do not specify) in the **onspaces** command is the default buffering mode for all smart large objects stored within the sbospace.

Important: In general, if read and write operations to the smart large objects are less than 8080 bytes, do not specify a buffering mode when you create the sbospace. If you are reading or writing short blocks of data, such as 2 kilobytes or 4 kilobytes, leave the default of “buffering=ON” to obtain better performance.

Programmers can override the default buffering mode when they create, open, or alter a smart-large-object instance with DataBlade API and the Informix ESQL/C functions. The DataBlade API and the Informix ESQL/C application programming interface provide the LO_NOBUFFER flag to allow lightweight I/O for smart large objects.

Important: Use the LO_NOBUFFER flag only when you read or write smart large objects in operations greater than 8080 bytes and you seldom access them. That is, if you have infrequent read or write function calls that read large amounts of data in a single function invocation, lightweight I/O can improve I/O performance.

For more information about these flags and functions, see the *IBM Informix DataBlade API Programmer's Guide* and the *IBM Informix ESQL/C Programmer's Manual*.

Related reference

 **onspaces -c -S:** Create an sbospace (Administrator's Reference)

Logging

If you decide to log all write operations on data stored in sbospaces, logical-log I/O activity and memory utilization increases.

For more information, see “Configuration parameters that affect sbospace I/O” on page 5-20.

How the Optical Subsystem affects performance

The Optical Subsystem extends the storage capabilities of the database server for simple large objects (TEXT or BYTE data) to write-once-read-many (WORM) optical subsystems. The database server uses a cache in memory to buffer initial TEXT or BYTE data pages requested from the Optical Subsystem.

The memory cache is a common storage area. The database server adds simple large objects requested by any application to the memory cache as long as the cache has space. To free space in the memory cache, the application must release the TEXT or BYTE data that it is using.

A significant performance advantage occurs when you retrieve TEXT or BYTE data directly into memory instead of buffering that data on disk. Therefore, proper cache sizing is important when you use the Optical Subsystem. You specify the total amount of space available in the memory cache with the OPCACHEMAX configuration parameter. Applications indicate that they require access to a portion of the memory cache when they set the **INFORMIXOPCACHE** environment variable. For details, see “*INFORMIXOPCACHE, an Optical Subsystem environment variable*” on page 5-25.

Simple large objects that cannot fit entirely into the space that remains in the cache are stored in the blob space that the STAGEBLOB configuration parameter names. This staging area acts as a secondary cache on disk for blob pages that are retrieved from the Optical Subsystem. Simple large objects that are retrieved from the Optical Subsystem are held in the staging area until the transactions that requested them are complete.

The database server administrator creates the staging-area blob space in one of the following ways:

- With ON-Monitor (UNIX only)
- With the ISA utility
- With the **onspaces** utility

You can use **onstat -O** or ISA (**Performance > Cache > Optical Cache**) to monitor utilization of the memory cache and STAGEBLOB blob space. If contention develops for the memory cache, increase the value listed in the configuration file for OPCACHEMAX. (The new value takes effect the next time that the database server starts shared memory.) For a complete description of the Optical Subsystem, see the *IBM Informix Optical Subsystem Guide*.

Environment variables and configuration parameters for the Optical Subsystem

The STAGEBLOB and OPCACHEMAX configuration parameters and the **INFORMIXOPCACHE** environment variable affect the performance of the Optical Subsystem.

STAGEBLOB, an Optical Subsystem configuration parameter

The STAGEBLOB configuration parameter identifies the blob space that is to be used as a staging area for TEXT or BYTE data that is retrieved from the Optical Subsystem, and it activates the Optical Subsystem.

If the configuration file does not list the STAGEBLOB parameter, the Optical Subsystem does not recognize the optical-storage subsystem.

The structure of the staging-area blob space is the same as all other database server blob spaces. When the database server administrator creates the staging area, it consists of only one chunk, but you can add more chunks as desired. You cannot mirror the staging-area blob space. The optimal size for the staging-area blob space depends on the following factors:

- The frequency of simple-large-object storage
- The frequency of simple-large-object retrieval
- The average size of the simple large object to be stored

To calculate the size of the staging-area blob space, you must estimate the number of simple large objects that you expect to reside there simultaneously and multiply that number by the average simple-large-object size.

Related reference

 [STAGEBLOB Configuration Parameter \(Administrator's Reference\)](#)

OPCACHEMAX, an Optical Subsystem configuration parameter

The OPCACHEMAX configuration parameter specifies the total amount of space that is available for simple-large-object retrieval in the memory cache that the Optical Subsystem uses.

Until the memory cache fills, it stores simple large objects that are requested by any application. Simple large objects that cannot fit in the cache are stored on disk in the blob space that the STAGEBLOB configuration parameter indicates. You can increase the size of the cache to reduce contention among simple-large-object requests and to improve performance for requests that involve the Optical Subsystem.

Related reference

 [OPCACHEMAX Configuration Parameter \(UNIX\) \(Administrator's Reference\)](#)

INFORMIXOPCACHE, an Optical Subsystem environment variable

The INFORMIXOPCACHE environment variable sets the size of the memory cache that a given application uses for simple-large-object retrieval.

If the value of this variable exceeds the maximum that the OPCACHEMAX configuration parameter specifies, OPCACHEMAX is used instead. If INFORMIXOPCACHE is not set in the environment, the cache size is set to OPCACHEMAX by default.

Related reference

 [INFORMIXOPCACHE environment variable \(SQL Reference\)](#)

Table I/O

One of the most frequent functions that the database server performs is to bring data and index pages from disk into memory. Pages can be read individually for brief transactions and sequentially for some queries. You can configure the number of pages that the database server brings into memory, and you can configure the timing of I/O requests for sequential scans.

You can also indicate how the database server is to respond when a query requests data from a dbspace that is temporarily unavailable.

The following sections describe these methods of reading pages.

For information about I/O for smart large objects, see “Factors that affect I/O for smart large objects” on page 5-19.

Sequential scans

When the database server performs a sequential scan of data or index pages, most of the I/O wait time is caused by seeking the appropriate starting page. To dramatically improve performance for sequential scans, you can bring in a number of contiguous pages with each I/O operation.

The action of bringing additional pages along with the first page in a sequential scan is called *read ahead*.

The timing of I/O operations that are needed for a sequential scan is also important. If the scan thread must wait for the next set of pages to be brought in after working its way through each batch, a delay occurs. Timing second and subsequent read requests to bring in pages before they are needed provides the greatest efficiency for sequential scans. The number of pages to bring in and the frequency of read-ahead I/O requests depends on the availability of space in the memory buffers. Read-ahead operations can increase page cleaning to unacceptable levels if too many pages are brought in with each batch or if batches are brought in too often.

Related concepts

“How RA_PAGES and RA_THRESHOLD affect table I/O” on page 5-28

Related reference

 [Configure the database server to read ahead \(Administrator's Guide\)](#)

Light scans

In some circumstances, Informix can perform a *light scan*, which is a sequential scan of large data tables that bypasses the overhead of the buffer pool. Light scans are the fastest means for performing sequential scans of large data tables.

Light scans provide some performance advantages over use of the buffer pool for sequential scans. These scans:

- Bypass the overhead of the buffer pool when many pages are read
- Prevent frequently accessed pages from being forced out of the buffer pool when many sequential pages are read for a single DSS query

- Transfer larger blocks of data in one I/O operation
These larger I/O blocks are usually 64 kilobytes or 128 kilobytes. To determine the I/O block size that your platform supports, see your machine notes file.

Light scans occur under these conditions:

- The optimizer chooses a sequential scan of the table.
- The number of pages in the table is greater than the number of buffers in the buffer pool.
- The isolation level obtains no lock or a shared lock on the table:
 - Dirty Read (including nonlogging databases) isolation level
 - Repeatable Read isolation level if the table has a shared or exclusive lock
 - Committed Read isolation if the table has a shared lock

Light scans do not occur under Cursor Stability isolation.

When the database server is using the `RTO_SERVER_RESTART` configuration parameter, light scans automatically set a flag for the next checkpoint to activate.

The database server does not perform light scans on system catalog tables.

When the `BATCHEDREAD_TABLE` configuration parameter is enabled and tables are larger than 1 MB, Informix can perform light scans on compressed tables, tables with rows that are larger than a page, and tables with `VARCHAR`, `LVARCHAR`, and `NVARCHAR` data. However, if the `BATCHEDREAD_TABLE` configuration parameter is set to 0 (off), the server cannot perform light scans on compressed tables, tables with rows that are larger than a page, and tables with `VARCHAR`, `LVARCHAR`, and `NVARCHAR` data.

You can use the `IFX_BATCHEDREAD_TABLE` environment option of the `SET ENVIRONMENT` statement or the `onmode -wm` command to change the value of the `BATCHEDREAD_TABLE` configuration parameter for a session. You can use the `onmode -wf` command to change the value of `BATCHEDREAD_TABLE` in the `ONCONFIG` file.

To view information about current light scans, run the `onstat -g scn` command.

If you have a long-running scan and the `BATCHEDREAD_TABLE` configuration parameter or the `IFX_BATCHEDREAD_TABLE` is enabled, you can run the `onstat -g scn` command to check the progress of the scan, to determine how long the scan will take before it completes, and to see whether the scan is a light scan or a bufferpool scan.

The following example shows some of the output from the `onstat -g scn` for a light scan. The word `Light` in the `Scan Type` field identifies the scan as a light scan.

SesID	Thread	Partnum	Rowid	Rows	Scan'd	Scan Type	Lock Mode	Notes
17	48	300002	207	15		Light		Forward row lookup

Related reference

- [BATCHEDREAD_TABLE configuration parameter \(Administrator's Reference\)](#)
- [onstat -g scn command: Print scan information \(Administrator's Reference\)](#)

Unavailable data

Another aspect of table I/O pertains to situations in which a query requests access to a table or fragment in a dbspace that is temporarily unavailable. When the database server determines that a dbspace is unavailable as the result of a disk failure, queries directed to that dbspace fail by default. The database server allows you to specify dbspaces that, when unavailable, can be skipped by queries,

For information about specifying dbspaces that, when unavailable, can be skipped by queries, see “How DATASKIP affects table I/O” on page 5-29.

Warning: If a dbspace containing data that a query requests is listed in the DATASKIP configuration parameter and is currently unavailable because of a disk failure, the data that the database server returns to the query can be inconsistent with the actual contents of the database.

Configuration parameters that affect table I/O

The RA_PAGES and RA_THRESHOLD configuration parameters affect read-ahead. In addition, the DATASKIP configuration parameter enables or disables data skipping.

The following sections describe the performance effects and considerations that are associated with these parameters.

Related reference

- [RA_PAGES configuration parameter \(Administrator's Reference\)](#)
- [RA_THRESHOLD configuration parameter \(Administrator's Reference\)](#)

How RA_PAGES and RA_THRESHOLD affect table I/O

The RA_PAGES configuration parameter indicates the number of pages that the database server brings into memory in a single I/O operation during sequential scans of data or index pages. The RA_THRESHOLD configuration parameter indicates the point at which the database server issues an I/O request to bring in the next set of pages from disk.

Because the greater portion of I/O wait time is involved in seeking the correct starting point on disk, you can increase efficiency of sequential scans by increasing the number of contiguous pages brought in with each transfer.

However, setting RA_PAGES too large or RA_THRESHOLD too high with respect to the value of buffers in the BUFFERPOOL configuration parameter can trigger unnecessary page cleaning to make room for pages that are not needed immediately.

Use the following formulas to calculate values for RA_PAGES and RA_THRESHOLD:

$$\begin{aligned} \text{RA_PAGES} &= ((\text{BUFFERS} * \text{bp_fract}) / (2 * \text{large_queries})) + 2 \\ \text{RA_THRESHOLD} &= ((\text{BUFFERS} * \text{bp_fract}) / (2 * \text{large_queries})) - 2 \end{aligned}$$

bp_fract

is the portion of data buffers to use for large scans that require read-ahead. If you want to allow large scans to take up to 75 percent of buffers, *bp_fract* would be 0.75.

large_queries

is the number of concurrent queries that require read-ahead that you intend to support.

Related concepts

“Sequential scans” on page 5-26

Related reference

[➤ RA_PAGES configuration parameter \(Administrator's Reference\)](#)

[➤ RA_THRESHOLD configuration parameter \(Administrator's Reference\)](#)

How DATASKIP affects table I/O

The DATASKIP configuration parameter allows you to specify which dbspaces, if any, queries can skip when those dbspaces are unavailable as the result of a disk failure. You can list specific dbspaces and turn data skipping on or off for all dbspaces.

For more information about setting the DATASKIP configuration parameter, see your *IBM Informix Administrator's Guide*.

The database server sets the sixth character in the SQLWARN array to W when data skipping is enabled. For more information about the SQLWARN array, see the *IBM Informix Guide to SQL: Tutorial*.

Warning: The database server cannot determine whether the results of a query are consistent when a dbspace is skipped. If the dbspace contains a table fragment, the user who executes the query must ensure that the rows within that fragment are not needed for an accurate query result. Turning DATASKIP on allows queries with incomplete data to return results that can be inconsistent with the actual state of the database. Without proper care, that data can yield incorrect or misleading query results.

Related reference

[➤ DATASKIP Configuration Parameter \(Administrator's Reference\)](#)

Background I/O activities

Background I/O activities do not service SQL requests directly. Many of these activities are essential to maintain database consistency and other aspects of database server operation. However, they create overhead in the CPU and take up I/O bandwidth.

These overhead activities take time away from queries and transactions. If you do not configure background I/O activities properly, too much overhead for these activities can limit the transaction throughput of your application.

The following list shows some background I/O activities:

- Checkpoints
- Logging
- Page cleaning

- Backup and restore
- Rollback and recovery
- Data replication
- Auditing

Checkpoints occur regardless of whether much database activity occurs; however, they can occur with greater frequency as activity increases. Other background activities, such as logging and page cleaning, occur more frequently as database use increases. Activities such as backups, restores, or fast recoveries occur only as scheduled or under exceptional circumstances.

For the most part, tuning your background I/O activities involves striking a balance between appropriate checkpoint intervals, logging modes and log sizes, and page-cleaning thresholds. The thresholds and intervals that trigger background I/O activity often interact; adjustments to one threshold might shift the performance bottleneck to another.

The following sections describe the performance effects and considerations that are associated with the configuration parameters that affect these background I/O activities.

Configuration parameters that affect checkpoints

The `RTO_SERVER_RESTART`, `CKPTINTVL`, `LOGSIZE`, `LOGFILES`, `PHYSFILE`, and `ONDBSPACEDOWN` configuration parameters affect checkpoints.

RTO_SERVER_RESTART and its effect on checkpoints

The `RTO_SERVER_RESTART` configuration parameter specifies the amount of time, in seconds, that Informix has to recover from an unplanned outage.

The performance advantage of enabling this configuration parameter is:

- Enabling fast recovery to meet the `RTO_SERVER_RESTART` policy by seeding the buffer pool with the data pages required by log replay.

The performance disadvantages of enabling this configuration parameter are:

- Increased physical log activity which might slightly impact transaction performance
- Increased checkpoint frequency, because the physical log space is depleted more quickly (You can increase the size of the physical log to avoid the increase in checkpoint frequency.)

When `RTO_SERVER_RESTART` is enabled, the database server:

- Attempts to make sure nonblocking checkpoints do not run out of critical resources during checkpoint processing by triggering more frequent checkpoints if transactions might run out of physical or logical log resources, which would cause transaction blocking.
- Ignores the `CKPTINTVL` configuration parameter.
- Automatically controls checkpoint frequency to meet the `RTO` policy and to prevent the server from running out of log resources.
- Automatically adjusts the number of AIO virtual processors and cleaner threads and automatically tunes LRU flushing.

The database server prints warning messages in the message log if the server cannot meet the `RTO_SERVER_RESTART` policy.

Related reference

[➡ RTO_SERVER_RESTART configuration parameter \(Administrator's Reference\)](#)

Automatic checkpoints, LRU tuning, and AIO virtual processor tuning:

The database server automatically adjusts checkpoint frequency to avoid transaction blocking. To accomplish this, the server monitors physical and logical log consumption along with information about past checkpoint performance. Then, if necessary, the server triggers checkpoints more frequently to avoid transaction blocking.

You can turn off automatic checkpoint tuning by setting **onmode -wf AUTO_CKPTS** to 0, or setting the AUTO_CKPTS configuration parameter to 0.

Because the database server does not block transactions during checkpoint processing, LRU flushing should be relaxed. If the server is not able to complete checkpoint processing before the physical log is consumed (which causes transaction blocking), and if you cannot increase the size of the physical log, you can configure the server for more aggressive LRU flushing. The increase in LRU flushing impacts transaction performance, but should reduce transaction blocking. If you do not configure the server for more aggressive flushing, the server automatically adjusts LRU flushing to be more aggressive only when the server is unable to find a low priority buffer for page replacement.

When the AUTO_AIOVPS configuration parameter is enabled, the database server automatically increases the number of AIO virtual processors and page-cleaner threads when the server detects that AIO virtual processors are not keeping up with the I/O workload.

Automatic LRU tuning affects all buffer pools and adjusts **lru_min_dirty** and **lru_max_dirty** values in the BUFFERPOOL configuration parameter. For more information about this and for information about turning off LRU tuning, see “LRU tuning” on page 5-46.

Related reference

[➡ AUTO_CKPTS Configuration Parameter \(Administrator's Reference\)](#)

[➡ AUTO_AIOVPS Configuration Parameter \(Administrator's Reference\)](#)

[➡ BUFFERPOOL configuration parameter \(Administrator's Reference\)](#)

CKPTINTVL and its effect on checkpoints

If the RTO_SERVER_RESTART configuration parameter is not on, the CKPTINTVL configuration parameter specifies the frequency, in seconds, at which the database server checks to determine whether a checkpoint is needed.

When the RTO_SERVER_RESTART configuration parameter is on, the database server ignores the CKPTINTVL configuration parameter. Instead, the server automatically triggers checkpoints in order to maintain the RTO_SERVER_RESTART policy.

The database server can skip a checkpoint if all data is physically consistent when the checkpoint interval expires.

Checkpoints also occur in either of these circumstances:

- Whenever the physical log becomes 75 percent full

- If a high number of dirty partitions exist, even if the physical log is not 75 percent full.

This occurs because when the database server checks if the physical log is 75 percent full, the server also checks if the following condition is true:

$$\frac{(\text{Physical Log Pages Used} + \text{Number of Dirty Partitions})}{(\text{Physical Log Size} * 9)} \geq 10$$

A partition, which represents one page going into the physical log during checkpoint processing and has a page that maintains information (such as the number of rows and number of data pages) about the partition, becomes dirty when the partition is updated.

If you set CKPTINTVL to a long interval, you can use physical-log capacity to trigger checkpoints based on actual database activity instead of an arbitrary time unit. However, a long checkpoint interval can increase the time needed for recovery in the event of a failure. Depending on your throughput and data-availability requirements, you can choose an initial checkpoint interval of 5, 10, or 15 minutes, with the understanding that checkpoints might occur more often, depending on physical-logging activity.

The database server writes a message to the message log to note the time that it completes a checkpoint. To read these messages, use **onstat -m**.

Related reference

 [CKPTINTVL Configuration Parameter \(Administrator's Reference\)](#)

LOGSIZE and LOGFILES and their effect on checkpoints

The LOGSIZE and LOGFILES configuration parameters indirectly affect checkpoints because they specify the size and number of logical-log files. A checkpoint can occur when the database server detects that the next logical-log file to become current contains the most-recent checkpoint record.

If you need to free the logical-log file that contains the last checkpoint, the database server must write a new checkpoint record to the current logical-log file. If the frequency with which logical-log files are backed up and freed increases, the frequency at which checkpoints occur increases. Although checkpoints block user processing, they no longer last as long. Because other factors (such as the physical-log size) also determine the checkpoint frequency, this effect might not be significant.

When the dynamic log allocation feature is enabled, the size of the logical log does not affect the thresholds for long transactions as much as it did in previous versions of the database server. For details, see “LTXHWM and LTXEHWM and their effect on logging” on page 5-39.

The LOGSIZE, LOGFILES, and LOGBUFF configuration parameters also affect logging I/O activity and logical backups. For more information, see “Configuration parameters that affect logging” on page 5-35.

Related concepts

[📄](#) Estimate the number of logical-log files (Administrator's Guide)

Related reference

[📄](#) LOGFILES Configuration Parameter (Administrator's Reference)

[📄](#) LOGSIZE Configuration Parameter (Administrator's Reference)

PHYSFILE and its effect on checkpoints

The PHYSFILE configuration parameter specifies the size of the initial physical log. Whenever the physical log becomes 75 percent full or a high number of dirty partitions exist, even if the physical log is not 75 percent full, a checkpoint occurs.

Because the physical log is an important part of maintaining RTO_SERVER_RESTART policy, you should have an abundance of physical log space. The size of the physical log should be at least 110 percent of the size of all buffer pools.

After you use the **oninit -i** command to initialize the disk space and bring the database server online, you can use the **onparams** utility to change the physical log location and size.

You can change the physical log while transactions are active and without restarting the database server.

Related concepts

[📄](#) Strategy for estimating the size of the physical log (Administrator's Guide)

Related reference

[📄](#) PHYSFILE Configuration Parameter (Administrator's Reference)

[📄](#) Change the physical-log location and size (Administrator's Guide)

How checkpoints affect the physical log:

The frequency of checkpoints affects the physical log. The size of the physical log and how quickly it fills are other factors to consider.

When analyzing the physical log, consider the following factors:

- How quickly the physical log fills

Operations that do not perform updates do not generate before-images. If the size of the database is growing, but applications rarely update the data, not much physical logging occurs. In this situation, you might not need a large physical log.

The database server writes the before-image of only the first update made to a page, for example, for the following operations:

- Inserts, updates, and deletes for rows that contain user-defined data types (UDTs), smart large objects, and simple large objects
- ALTER statements
- Operations that create or modify indexes (B-tree, R-tree, or user-defined indexes)

Thus, you can define a smaller physical log if your application updates the same pages.

- How frequently checkpoints occur

Because the physical log is recycled after each checkpoint, the physical log must be large enough to hold before-images from changes between checkpoints. If the database server frequently triggers checkpoints because it runs out of physical log space, consider increasing the size of the physical log.

- When to increase the size of the physical log

If you increase the checkpoint interval or if you anticipate increased update activity, you might want to increase the size of the physical log.

For information about the physical log and checkpoints, see *Physical logging, checkpoints, and fast recovery* in your *IBM Informix Administrator's Guide*.

ONDBSPACEDOWN and its effect on checkpoints

The ONDBSPACEDOWN configuration parameter specifies the response that the database server makes when an I/O error indicates that a dbspace is down. By default, the database server identifies any dbspace that contains no critical data as down and continues processing. Critical data includes the root dbspace, the logical log, or the physical log.

To restore access to that database, you must back up all logical logs and then perform a warm restore on the down dbspace.

The database server halts operation whenever a disabling I/O error occurs on a nonmirrored dbspace that contains critical data, regardless of the setting for ONDBSPACEDOWN. In such an event, you must perform a cold restore of the database server to resume normal database operations.

The value of ONDBSPACEDOWN has no affect on temporary dbspaces. For temporary dbspaces, the database server continues processing regardless of the ONDBSPACEDOWN setting. If a temporary dbspace requires fixing, you can drop and recreate it.

When ONDBSPACEDOWN is set to 2, the database server continues processing to the next checkpoint and then suspends processing of all update requests. The database server repeatedly retries the I/O request that produced the error until the dbspace is repaired and the request completes or the database server administrator intervenes. The administrator can use **onmode -O** to mark the dbspace down and continue processing while the dbspace remains unavailable or use **onmode -k** to halt the database server.

Important: This 2 setting for ONDBSPACEDOWN can affect the performance for update requests severely because they are suspended due to a down dbspace. When you use this setting for ONDBSPACEDOWN, be sure to monitor the status of the dbspaces.

When you set ONDBSPACEDOWN to 1, the database server treats all dbspaces as though they were critical. Any nonmirrored dbspace that becomes disabled halts normal processing and requires a cold restore. The performance impact of halting and performing a cold restore when any dbspace goes down can be severe.

Important: If you decide to set ONDBSPACEDOWN to 1, consider mirroring all your dbspaces.

Related reference

[👉 ONDBSPACEDOWN Configuration Parameter \(Administrator's Reference\)](#)

Configuration parameters that affect logging

The LOGBUFF, PHYSBUFF, LOGFILES, LOGSIZE, DYNAMIC_LOGS, LTXHWM, LTXEHWM and TEMPTAB_NOLOG configuration parameters affect logging.

Logging, checkpoints, and page cleaning are necessary to maintain database consistency. A direct trade-off exists between the frequency of checkpoints or the size of the logical logs and the time that it takes to recover the database in the event of a failure. Therefore, a major consideration when you attempt to reduce the overhead for these activities is the delay that you can accept during recovery.

LOGBUFF and PHYSBUFF and their effect on logging

The LOGBUFF and PHYSBUFF configuration parameters affect logging I/O activity because they specify the respective sizes of the logical-log and physical-log buffers that are in shared memory. The size of these buffers determines how quickly the buffers fill and therefore how often they need to be flushed to disk.

Related reference

[👉 LOGBUFF Configuration Parameter \(Administrator's Reference\)](#)

[👉 PHYSBUFF Configuration Parameter \(Administrator's Reference\)](#)

LOGFILES and its effect on logging

The LOGFILES configuration parameter, which specifies the number of logical-log files, affects logging.

When you initialize or restart the database server, it creates the number of logical-log files that you specify in the LOGFILES configuration parameter.

You might add logical-log files for the following reasons:

- To increase the disk space allocated to the logical log
- To change the size of your logical-log files
- To enable an open transaction to roll back
- As part of moving logical-log files to a different dbspace

Related concepts

[👉 Estimate the number of logical-log files \(Administrator's Guide\)](#)

Related reference

[👉 LOGFILES Configuration Parameter \(Administrator's Reference\)](#)

Calculating the space allocated to logical log files:

If all of your logical log files are the same size, you can calculate the total space allocated to the logical log files.

To calculate the space allocated to these files, use the following formula:

total logical log space = LOGFILES * LOGSIZE

If you add logical-log files that are not the size specified by the LOGSIZE configuration parameter, you cannot use the LOGFILES * LOGSIZE expression to calculate the size of the logical log. Instead, you need to add the sizes for each individual log file on disk.

Use the `onstat -l` utility to monitor logical-log files.

LOGSIZE and its effect on logging

The LOGSIZE configuration parameter specifies the size of each logical log file. It is difficult to predict how much logical-log space your database server system requires until the system is fully in use.

The size of the logical log space (LOGFILES * LOGSIZE) is determined by these policies:

Recovery time objective (RTO)

This is the length of time you can afford to be without your systems. If your only objective is failure recovery, the total log space only needs to be large enough to contain all the transactions for two checkpoint cycles. When the RTO_SERVER_RESTART configuration parameter is enabled and the server has a combined buffer pool size of less than four gigabytes, you can configure the total log space to 110% of the combined buffer pool sizes. Too much log space does not impact performance; however, too little log space can cause more frequent checkpoints and transaction blocking.

Recovery point objective (RPO)

This describes the age of the data you want to restore in the event of a disaster. If the objective is to make sure transactional work is protected, the optimum LOGSIZE should be a multiple of how much work gets done per RPO unit. Because the database server supports partial log backup, an optimal log size is not critical and a non-optimal log size simply means more frequent log file changes. RPO is measured in units of time. If the business rule is that the system cannot lose more than ten minutes of transactional data if a complete site disaster occurs, then a log backup should occur every ten minutes.

You can use the Scheduler, which manages and executes scheduled administrative tasks, to set up automatic log backup.

Long Transactions

If you have long transactions that require a large amount of log space, you should allocate that space for the logs. Inadequate log space impacts transaction performance.

Choose a log size based on how much logging activity occurs and the amount of risk in case of catastrophic failure. If you cannot afford to lose more than an hour's worth of data, create many small log files that each hold an hour's worth of transactions. Turn on continuous-log backup. Small logical-log files fill sooner, which means more frequent logical-log backups.

If your system is stable with high logging activity, choose larger logs to improve performance. Continuous-log backups occur less frequently with large log files. Also consider the maximum transaction rates and speed of the backup devices. Do not let the whole logical log fill. Turn on continuous-log backup and leave enough room in the logical logs to handle the longest transactions.

The backup process can hinder transaction processing that involves data located on the same disk as the logical-log files. If enough logical-log disk space is available, however, you can wait for periods of low user activity before you back up the logical-log files.

Related concepts

 [The Scheduler \(Administrator's Guide\)](#)

Related reference

 [LOGSIZE Configuration Parameter \(Administrator's Reference\)](#)

Estimating logical-log size when logging dbspaces:

To estimate the size of logical logs, use a formula or **onstat -u** information.

Use the following formula to obtain an initial estimate for LOGSIZE in kilobytes:

$LOGSIZE = (connections * maxrows * rowsize) / 1024 / LOGFILES$

In this formula:

- *connections* is the maximum number of connections for all network types specified in the **sqlhosts** file or registry by one or more NETTYPE parameters. If you configured more than one connection by setting multiple NETTYPE configuration parameters in your configuration file, sum the **users** fields for each NETTYPE parameter, and substitute this total for *connections* in the preceding formula.
- *maxrows* is the largest number of rows to be updated in a single transaction.
- *rowsize* is the average size of a row in bytes. You can calculate *rowsize* by adding up the length (from the **syscolumns** system catalog table) of the columns in a row.
- *1024* is a necessary divisor because you specify LOGSIZE in kilobytes.

To obtain a better estimate during peak activity periods, execute the **onstat -u** command. The last line of the **onstat -u** output contains the maximum number of concurrent connections.

You need to adjust the size of the logical log when your transactions include simple large objects or smart large objects, as the following sections describe.

You also can increase the amount of space devoted to the logical log by adding another logical-log file.

Related tasks

 [Adding logical-log files manually \(Administrator's Guide\)](#)

Estimating the logical-log size when logging simple large objects:

To obtain better overall performance for applications that perform frequent updates of TEXT or BYTE data in blobspaces, reduce the size of the logical log.

Blobspages cannot be reused until the logical log to which they are allocated is backed up. When TEXT or BYTE data activity is high, the performance impact of more frequent checkpoints is balanced by the higher availability of free blobpages.

When you use volatile blobpages in blobspaces, smaller logs can improve access to simple large objects that must be reused. Simple large objects cannot be reused until the log in which they are allocated is flushed to disk. In this case, you can justify the cost in performance because those smaller log files are backed up more frequently.

Estimating the logical-log size when logging smart large objects:

If you plan to log smart-large-object user data, you must ensure that the log size is considerably larger than the amount of data being written. Smart-large-object metadata is always logged even if the smart large objects are not logged.

Use the following guidelines when you log smart large objects:

- If you are appending data to a smart large object, the increased logging activity is roughly equal to the amount of data written to the smart large object.
- If you are updating a smart large object (overwriting data), the increased logging activity is roughly twice the amount of data written to the smart large object. The database server logs both the before-image and after-image of a smart large object for update transactions. When updating the smart large objects, the database server logs only the updated parts of the before and after image.
- Metadata updates affect logging less. Even though metadata is always logged, the number of bytes logged is usually much smaller than the smart large objects.

DYNAMIC_LOGS and its effect on logging

The dynamic log file allocation feature prevents hanging problems that are caused by rollbacks of a long transaction because the database server does not run out of log space. The DYNAMIC_LOGS configuration parameter specifies whether the dynamic log file allocation feature is off, on, or causes the server to pause to allow the manual addition of a logical log file.

Dynamic log allocation allows you to do the following actions:

- Add a logical log file while the system is active, even during fast recover.
- Insert a logical log file immediately after the current log file, instead of appending it to the end.
- Immediately access the logical log file even if the root dbspace is not backed up.

The default value for the DYNAMIC_LOGS configuration parameter is 2, which means that the database server automatically allocates a new logical log file after the current log file when it detects that the next log file contains an open transaction. The database server automatically checks if the log after the current log still contains an open transaction at the following times:

- Immediately after it switches to a new log file while writing log records (not while reading and applying log records)
- At the beginning of the transaction cleanup phase which occurs as the last phase of logical recovery
Logical recovery happens at the end of fast recovery and at the end of a cold restore or roll forward.
- During transaction cleanup (rollback of open transactions), a switch to a new log file log might occur
The database server also checks after this switch because it is writing log records for the rollback.

When you use the default value of 2 for DYNAMIC_LOGS, the database server determines the location and size of the new logical log for you:

- The database server uses the following criteria to determine on which disk to allocate the new log file:
 - Favor mirrored dbspaces
 - Avoid root dbspace until no other critical dbspace is available
 - Least favored space is unmirrored and noncritical dbspaces

- The database server uses the average size of the largest log file and the smallest log file for the size of the new logical log file. If not enough contiguous disk space is available for this average size, the database server searches for space for the next smallest average size. The database server allocates a minimum of 200 kilobytes for the new log file.

If you want to control the location and size of the additional log file, set `DYNAMIC_LOGS` to 1. When the database server switches log files, it still checks if the next active log contains an open transaction. If it does find an open transaction in the next log to be active, it does the following actions:

- Issues alarm event 27 (log required)
- Writes a warning message to the online log
- Pauses to wait for the administrator to manually add a log with the `onparams -a -i` command-line option

You can write a script that will execute when alarm event 27 occurs to execute `onparams -a -i` with the location you want to use for the new log. Your script can also execute the `onstat -d` command to check for adequate space and execute the `onparams -a -i` command with the location that has enough space. You must use the `-i` option to add the new log right after the current log file.

If you set `DYNAMIC_LOGS` to 0, the database server still checks whether the next active log contains an open transaction when it switches log files. If it does find an open transaction in the next log to be active, it issues the following warning:

```
WARNING: The oldest logical log file (%d) contains records
from an open transaction (0x%p), but the Dynamic Log
Files feature is turned off.
```

Related concepts

 [Fast recovery \(Administrator's Guide\)](#)

Related reference

 [DYNAMIC_LOGS Configuration Parameter \(Administrator's Reference\)](#)

LTXHWM and LTXEHWM and their effect on logging

With the dynamic log file feature, the long transaction high watermarks are no longer as critical as in database server versions prior to Version 9.3, because the server does not run out of log space unless you use up the physical disk space available on the system. The `LTXHWM` and `LTXEHWM` configuration parameters define long transaction watermarks.

The `LTXHWM` parameter still indicates how full the logical log is when the database server starts to check for a possible long transaction and to roll it back. `LTXEHWM` still indicates the point at which the database server suspends new transaction activity to locate and roll back a long transaction. These events should be rare, but if they occur, they can indicate a serious problem within an application.

Under normal operations, use the default values for `LTXHWM` and `LTXEHWM`. However, you might want to change these default values for one of the following reasons:

- To allow other transactions to continue update activity (which requires access to the log) during the rollback of a long transaction
In this case, you increase the value of `LTXEHWM` to raise the point at which the long transaction rollback has exclusive access to the log.

- To perform scheduled transactions of unknown length, such as large loads that are logged

In this case, you increase the value of LTXHWM so that the transaction has a chance to complete before reaching the high watermark.

Related reference

[➡ LTXEHWM Configuration Parameter \(Administrator's Reference\)](#)

[➡ LTXHWM Configuration Parameter \(Administrator's Reference\)](#)

TEMPTAB_NOLOG and its effect on logging

The TEMPTAB_NOLOG configuration parameter allows you to disable logging on temporary tables. You can do this to improve performance and to prevent Informix from transferring temporary tables when using High-Availability Data Replication (HDR).

To disable logging on temporary tables, set the TEMPTAB_NOLOG configuration parameter to 1.

Related reference

[➡ TEMPTAB_NOLOG Configuration Parameter \(Administrator's Reference\)](#)

Configuration parameters that affect page cleaning

Several configuration parameters, including the CLEANERS and RTO_SERVER_RESTART configuration parameters, affect page cleaning. If pages are not cleaned often enough, an `sqlexec` thread that performs a query might be unable to find the available pages that it needs.

If the `sqlexec` thread cannot find the available pages that it needs, the thread initiates a *foreground write* and waits for pages to be freed. Foreground writes impair performance, so you should avoid them. To reduce the frequency of foreground writes, increase the number of page cleaners or decrease the threshold for triggering a page cleaning.

Use `onstat -F` to monitor the frequency of foreground writes.

The following configuration parameters affect page cleaning:

- BUFFERPOOL, which contains `lrus`, `lru_max_dirty`, and `lru_min_dirty` values
Information that was specified with the BUFFERS, LRUS, LRU_MAX_DIRTY, and LRU_MIN_DIRTY configuration parameters before Version 10.0 is now specified using the BUFFERPOOL configuration parameter.
- CLEANERS
- RA_PAGES and RA_THRESHOLD
- RTO_SERVER_RESTART

“How RA_PAGES and RA_THRESHOLD affect table I/O” on page 5-28 describes the RA_PAGES and RA_THRESHOLD parameters.

CLEANERS and its effect on page cleaning

The CLEANERS configuration parameter indicates the number of page-cleaner threads to run. For installations that support fewer than 20 disks, one page-cleaner thread is recommended for each disk that contains database server data. For installations that support between 20 and 100 disks, one page-cleaner thread is recommended for every two disks. For larger installations, one page-cleaner thread is recommended for every four disks.

If you increase the number of LRU queues, you must increase the number of page-cleaner threads proportionally.

Related reference

[➔ CLEANERS Configuration Parameter \(Administrator's Reference\)](#)

BUFFERPOOL and its effect on page cleaning

The **BUFFERPOOL** configuration parameter specifies the number of least recently used (LRU) queues to set up within the shared-memory buffer pool. The buffer pool is distributed among LRU queues. Configuring more LRU queues allows more page cleaners to operate and reduces the size of each LRU queue.

For a single-processor system, you should set the **lrus** option of the **BUFFERPOOL** configuration parameter to a minimum of 4. For multiprocessor systems, set the **lrus** to a minimum of 4 or to the number of CPU VPs, whichever is greater.

The **lrus**, **lru_max_dirty**, and **lru_min_dirty** values control how often pages are flushed to disk between checkpoints. Automatic LRU tuning affects all buffer pools and adjusts **lru_min_dirty** and **lru_max_dirty** values in the **BUFFERPOOL** configuration parameter.

If you increase the **lru_max_dirty** and **lru_min_dirty** values to improve transaction throughput, do not change the gap between the **lru_max_dirty** and **lru_min_dirty**.

When the buffer pool is very large and transaction blocking is occurring during checkpoint processing, look in the message log to determine which resource is triggering transaction blocking. If the physical or logical log is critically low and triggers transaction blocking, increase the size of the resource that is causing the transaction blocking. If you cannot increase the size of the resource, consider making LRU flushing more aggressive by decreasing the **lru_min_dirty** and **lru_max_dirty** settings so that the server has fewer pages to flush to disk during checkpoint processing.

To monitor the percentage of dirty pages in LRU queues, use the **onstat -R** command. When the number of dirty pages consistently exceeds the **lru_max_dirty** limit, you have too few LRU queues or too few page cleaners. First, use the **BUFFERPOOL** configuration parameter to increase the number of LRU queues. If the percentage of dirty pages still exceeds the **lru_max_dirty** limit, use the **CLEANERS** configuration parameter to increase the number of page cleaners.

Related reference

[➔ BUFFERPOOL configuration parameter \(Administrator's Reference\)](#)

RTO_SERVER_RESTART and its effect on page cleaning

The **RTO_SERVER_RESTART** configuration parameter allows you to use recovery time objective (RTO) standards to set the amount of time, in seconds, that Informix has to recover from a problem after you restart Informix and bring it into online or quiescent mode.

When this configuration parameter is enabled, the database server automatically adjusts the number of AIO virtual processors and cleaner threads and automatically tunes LRU flushing.

Use the **AUTO_LRU_TUNING** configuration parameter to specify whether automatic LRU tuning is enabled or disabled when the server starts.

Related reference

- [RTO_SERVER_RESTART configuration parameter \(Administrator's Reference\)](#)
- [AUTO_LRU_TUNING Configuration Parameter \(Administrator's Reference\)](#)

Configuration parameters that affect backup and restore

Four configuration parameters that affect backup and restore on all operating systems also affect background I/O. Additional configuration parameters affect backup and restore on UNIX.

The following configuration parameters affect backup and restore on all operating systems:

- BAR_MAX_BACKUP
- BAR_NB_XPORT_COUNT
- BAR_PROGRESS_FREQ
- BAR_XFER_BUF_SIZE

In addition, the following configuration parameters affect backup and restore on UNIX:

- LTAPEBLK
- LTAPEDEV
- LTAPESIZE
- TAPEBLK
- TAPEDEV
- TAPESIZE

ON-Bar configuration parameters

BAR_MAX_BACKUP, BAR_NB_XPORT_COUNT, BAR_PROGRESS_FREQ, and BAR_XFER_BUF_SIZE are some ON-Bar configuration parameters that affect background I/O.

The BAR_MAX_BACKUP configuration parameter specifies the maximum number of backup processes per ON-Bar command. This configuration parameter also defines the degree of parallelism, determining how many processes start to run concurrently, including processes for backing up and restoring a whole system. When the number of running processes is reached, further processes start only when a running process completes its operation.

BAR_NB_XPORT_COUNT specifies the number of shared-memory data buffers for each backup or restore process.

BAR_PROGRESS_FREQ specifies, in minutes, how frequently the backup or restore progress messages display in the activity log.

BAR_XFER_BUF_SIZE specifies the size, in pages, of the buffers.

Related reference

- [BAR_MAX_BACKUP parameter \(Backup and Restore Guide\)](#)
- [BAR_NB_XPORT_COUNT parameter \(Backup and Restore Guide\)](#)
- [BAR_PROGRESS_FREQ parameter \(Backup and Restore Guide\)](#)
- [BAR_XFER_BUF_SIZE parameter \(Backup and Restore Guide\)](#)

ontape configuration parameters (UNIX)

On UNIX, LTAPEBLK, LTAPEDEV, LTAPESIZE, TAPEBLK, TAPEDEV, and TAPESIZE are configuration parameters that affect the **ontape** utility.

On UNIX, the LTAPEBLK, LTAPEDEV, and TAPESIZE configuration parameters specify the block size, device, and tape size for logical-log backups made with **ontape**. The TAPEBLK configuration parameter specifies the block size for database backups made with **ontape**, **onload**, and **onunload**.

TAPEDEV specifies the tape device. TAPESIZE specifies the tape size for these backups.

Related reference

- [LTAPEBLK Configuration Parameter \(Administrator's Reference\)](#)
- [LTAPEDEV Configuration Parameter \(Administrator's Reference\)](#)
- [LTAPESIZE Configuration Parameter \(Administrator's Reference\)](#)
- [TAPEBLK Configuration Parameter \(Administrator's Reference\)](#)
- [TAPEDEV configuration parameter \(Administrator's Reference\)](#)
- [TAPESIZE Configuration Parameter \(Administrator's Reference\)](#)

Configuration parameters that affect rollback and recovery

The OFF_RECVRY_THREADS, ON_RECVRY_THREADS, PLOG_OVERFLOW_PATH, and RTO_SERVER_RESTART configuration parameters affect recovery. The LOW_MEMORY_RESERVE configuration parameter reserves a specific amount of memory, in kilobytes, for the database server to use when critical activities, such as rollback activities, are needed.

OFF_RECVRY_THREADS and ON_RECVRY_THREADS and their effect on fast recovery

The OFF_RECVRY_THREADS and ON_RECVRY_THREADS configuration parameters specify the number of recovery threads that operate when the database server performs a cold restore, warm restore, or fast recovery. The setting of ON_RECVRY_THREADS controls warm restores, and the setting of OFF_RECVRY_THREADS controls cold restores and fast recovery.

To improve the performance of fast recovery, increase the number of fast-recovery threads with the OFF_RECVRY_THREADS configuration parameter. The number of threads should usually match the number of tables or fragments that are frequently updated to roll forward the transactions recorded in the logical log.

Another estimate is the number of tables or fragments that experience frequent updates. On a single-CPU host, the number of threads should be no fewer than 10 and no more than 30 or 40. At a certain point, the overhead that is associated with each thread outweighs the advantages of parallel threads.

A warm restore takes place concurrently with other database operations. To reduce the impact of the warm restore on other users, you can allocate fewer threads to it than you would allocate to a cold restore. However, to replay logical-log transactions in parallel during a warm restore, specify more threads in the `ON_RECOVERY_THREADS` configuration parameter.

Related reference

[OFF_RECOVERY_THREADS configuration parameter \(Administrator's Reference\)](#)

[ON_RECOVERY_THREADS Configuration Parameter \(Administrator's Reference\)](#)

PLOG_OVERFLOW_PATH and its effect on fast recovery

The `PLOG_OVERFLOW_PATH` configuration parameter specifies the location of a disk file (named `plog_extend.servernum`) that the database server uses if the physical log file overflows during fast recovery.

The database server removes the `plog_extend.servernum` file when the first checkpoint is performed during a fast recovery.

Related reference

[PLOG_OVERFLOW_PATH Configuration Parameter \(Administrator's Reference\)](#)

RTO_SERVER_RESTART and its effect on fast recovery

The `RTO_SERVER_RESTART` configuration parameter enables you to use recovery time objective (RTO) standards to set the amount of time, in seconds, that Informix has to recover from a problem after you restart Informix and bring it into online or quiescent mode.

Related reference

[RTO_SERVER_RESTART configuration parameter \(Administrator's Reference\)](#)

The LOW_MEMORY_RESERVE configuration parameter and memory utilization

The `LOW_MEMORY_RESERVE` configuration parameter reserves a specific amount of memory, in kilobytes, for the database server to use when critical activities are needed and the server has limited free memory.

If you enable the new `LOW_MEMORY_RESERVE` configuration parameter by setting it to a specified value in kilobytes, critical activities, such as rollback activities, can complete even when you receive out-of-memory errors.

Related reference

[LOW_MEMORY_RESERVE configuration parameter \(Administrator's Reference\)](#)

[onstat -g seg command: Print shared memory segment statistics \(Administrator's Reference\)](#)

Configuration parameters that affect data replication and auditing

Data replication and auditing are optional. If you use these features, you can set configuration parameters that affect data-replication performance and auditing performance.

To obtain immediate performance improvements, you can disable these features, provided that the operating requirements for your system allow you to do so.

Configuration parameters that affect data replication

The DRINTERVAL and DRTIMEOUT configuration parameters affect data-replication performance.

Data replication typically adds overhead to logical-log I/O that is proportional to your logging activity. A configuration that optimizes logging activity without data replication is likely to optimize logging with data replication.

The DRINTERVAL configuration parameter indicates whether the data-replication buffer is flushed synchronously or asynchronously to the secondary database server. If this parameter is set to flush asynchronously, it specifies the interval between flushes. Each flush impacts the CPU and sends data across the network to the secondary database server.

The DRTIMEOUT configuration parameter specifies the interval for which either database server waits for a transfer acknowledgment from the other. If the primary database server does not receive the expected acknowledgment, it adds the transaction information to the file named in the DRLOSTFOUND configuration parameter. If the secondary database server receives no acknowledgment, it changes the data-replication mode as the DRAUTO configuration parameter specifies.

Related reference

- [➤ DRINTERVAL Configuration Parameter \(Administrator's Reference\)](#)
- [➤ DRTIMEOUT Configuration Parameter \(Administrator's Reference\)](#)
- [➤ DRLOSTFOUND Configuration Parameter \(Administrator's Reference\)](#)
- [➤ DRAUTO Configuration Parameter \(Administrator's Reference\)](#)

Configuration parameters that affect auditing

The ADTERR and ADTMODE configuration parameters affect auditing performance.

The ADTERR configuration parameter specifies whether the database server is to halt processing for a user session for which an audit record encounters an error. When ADTERR is set to halt such a session, the response time for that session appears to degrade until one of the successive attempts to write the audit record succeeds.

The ADTMODE configuration parameter enables or disables auditing according to the audit records that you specify with the **onaudit** utility. Records are written to files in the directory that the AUDITPATH parameter specifies. The AUDITSIZE parameter specifies the size of each audit-record file.

The effect of auditing on performance is largely determined by the auditing events that you choose to record. Depending on which users and events are audited, the impact of these configuration parameters can vary widely.

Infrequent events, such as requests to connect to a database, have low performance impact. Frequent events, such as requests to read any row, can generate a large amount of auditing activity. The more users for whom such frequent events are audited, the greater the impact on performance.

Related reference

 [ADTERR configuration parameter \(Security Guide\)](#)

 [ADTMODE configuration parameter \(Security Guide\)](#)

Related information

 [Auditing data security \(Security Guide\)](#)

LRU tuning

The LRU settings for flushing each buffer pool between checkpoints are not critical to checkpoint performance. The LRU settings are necessary only for maintaining enough clean pages for page replacement.

The default settings for LRU flushing are 50 percent for **lru_min_dirty** and 60 percent for **lru_max_dirty**.

If your database server has been configured for more aggressive LRU flushing because of checkpoint performance, you can decrease the LRU flushing at least to the default values.

The database server automatically tunes LRU flushing when the **AUTO_LRU_TUNING** configuration parameter is on and in the following cases:

- A page replacement is forced to perform a foreground write in order to find an empty page. In this case, LRU flushing is adjusted to be 5 percent more aggressive for the specific bufferpool where the foreground write took place.
- A page replacement is forced to use a buffer that is marked as high priority, meaning it is frequently accessed. In this case, LRU flushing is adjusted to be one (1) percent more aggressive for the specific bufferpool where the page replacement using high priority buffer took place.
- If the **RTO_SERVER_RESTART** configuration parameter is on and the time it takes to flush the bufferpool is longer than the recovery time objective, LRU flushing is adjusted to be 10 percent more aggressive for all bufferpools.

After a checkpoint has occurred, if a page replacement performed a foreground write during the previous checkpoint interval, the database server increases the LRU settings by 5 percent and continues to increase the LRU flushing at each subsequent checkpoint until the foreground write stops or until the **lru_max_dirty** for a given buffer pool falls below 10 percent. For example, if a page replacement performs a foreground write and the LRU settings for a buffer pool are 80 and 90, the database server adjusts these to 76 and 85.5.

In addition to foreground writes, LRU flushing is tuned more aggressively whenever a page fault replaces high priority buffers and non-high priority buffers are on the modified LRU queue. Automatic LRU adjustments only make LRU flushing more aggressive; they do not decrease LRU flushing. Automatic LRU adjustments are not permanent and are not recorded in the ONCONFIG file.

LRU flushing is reset to the values contained in the ONCONFIG file on which the database server starts.

The **AUTO_LRU_TUNING** configuration parameter specifies whether automatic LRU tuning is enabled or disabled when the server starts.

Related reference

- [➤ AUTO_LRU_TUNING Configuration Parameter \(Administrator's Reference\)](#)
- [➤ RTO_SERVER_RESTART configuration parameter \(Administrator's Reference\)](#)

Chapter 6. Table performance considerations

Some performance issues are associated with unfragmented tables and table fragments.

Issues include:

- Table placement on disk to increase throughput and reduce contention
- Space estimates for tables, blobpages, sbspaces, and extents
- Changes to tables that add or delete historical data
- Denormalization of the database to reduce overhead

Placing tables on disk

Tables that the database server supports reside on one or more portions of one or more disks. You control the placement of a table on disk when you create it by assigning it to a dbspace.

Tables that the database server supports reside on one or more portions of a disk or disks. You control the placement of a table on disk when you create it by assigning it to a dbspace. A dbspace consists of one or more chunks. Each chunk corresponds to all or part of a disk partition. When you assign chunks to dbspaces, you make the disk space in those chunks available for storing tables or table fragments.

When you configure chunks and allocate them to dbspaces, you must relate the size of the dbspaces to the tables or fragments that each dbspace is to contain. To estimate the size of a table, follow the instructions in “Estimating table size” on page 6-5.

The database administrator (DBA) who is responsible for creating a table assigns that table to a dbspace in one of the following ways:

- By using the IN DBSPACE clause of the CREATE TABLE statement
- By using the dbspace of the current database

The most recent DATABASE or CONNECT statement that the DBA issues before issuing the CREATE TABLE statement sets the current database.

The DBA can fragment a table across multiple dbspaces, as described in “Planning a fragmentation strategy” on page 9-1, or use the ALTER FRAGMENT statement to move a table to another dbspace. The ALTER FRAGMENT statement provides the simplest method for altering the placement of a table. However, the table is unavailable while the database server processes the alteration. Schedule the movement of a table or fragment at a time that affects the fewest users. For a description of the ALTER FRAGMENT statement, see the *IBM Informix Guide to SQL: Syntax*.

Other methods exist for moving tables between dbspaces. A DBA can unload the data from a table and then move that data to another dbspace with the SQL statements LOAD and UNLOAD, as the *IBM Informix Guide to SQL: Syntax* describes. The database server administrator can perform the same actions with the

onload and **onunload** utilities, as the *IBM Informix Migration Guide* describes, or with the High-Performance Loader (HPL), as the *IBM Informix High-Performance Loader User's Guide* describes.

Moving tables between databases with LOAD and UNLOAD, **onload** and **onunload**, or HPL involves periods in which data from the table is copied to tape and then reloaded onto the system. These periods present windows of vulnerability during which a table can become inconsistent with the rest of the database. To prevent the table from becoming inconsistent, you must restrict access to the version that remains on disk while the data transfers occur.

Depending on the size, fragmentation strategy, and indexes that are associated with a table, it can be faster to unload a table and reload it than to alter fragmentation. For other tables, it can be faster to alter fragmentation. You can experiment to determine which method is faster for a table that you want to move or re-partition.

Isolating high-use tables

You can place a table with high I/O activity on a dedicated disk device. Doing this reduces contention for the data that is stored in that table.

When disk drives have different performance levels, you can put the tables with the highest use on the fastest drives. Placing two high-use tables on separate disk devices reduces competition for disk access when the two tables experience frequent, simultaneous I/O from multiple applications or when joins are formed between them.

To isolate a high-use table on its own disk device, assign the device to a chunk, assign that chunk to a dbspace, and then place the table in the dbspace that you created. Figure 6-1 shows three high-use tables, each in a separate dbspace, placed on three disks.

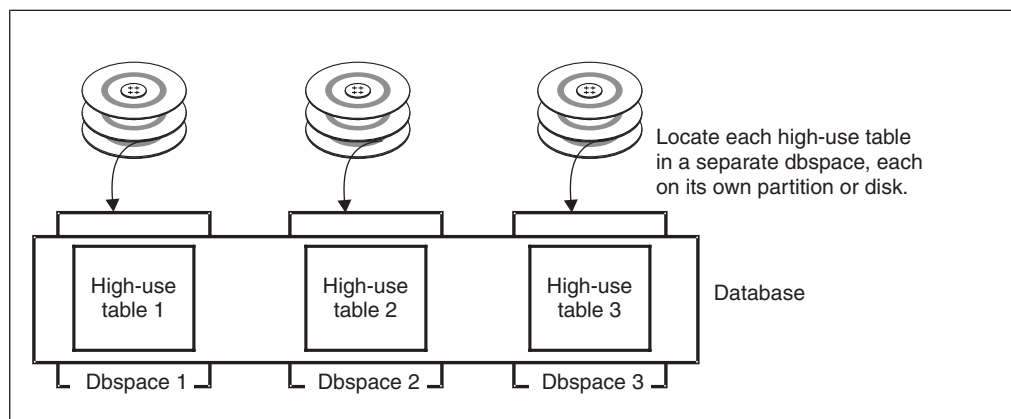

Figure 6-1. Isolating high-use tables

Placing high-use tables on middle partitions of disks

To minimize disk-head movement, place the most frequently accessed data on partitions close to the middle band of the disk (not near the center and not near the edge). This approach minimizes disk-head movement to reach data in the high-demand table.

The following figure shows the placement of the most frequently accessed data on partitions close to the middle band of the disk.

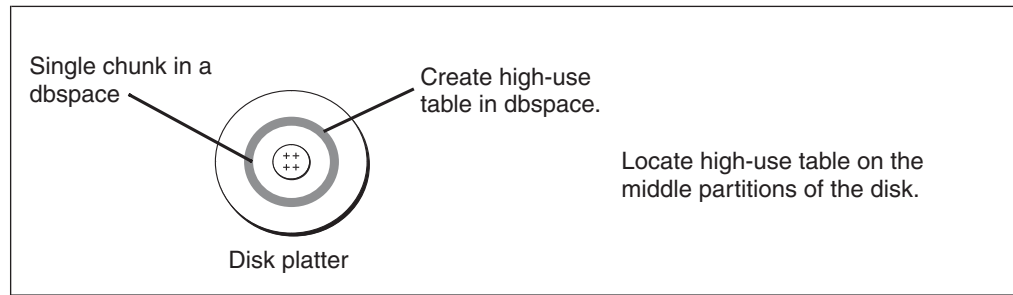

Figure 6-2. Disk platter with high-use table located on middle Partitions

To place high-use tables on the middle partition of the disk, create a raw device composed of cylinders that reside midway between the spindle and the outer edge of the disk. (For instructions on how to create a raw device, see the *IBM Informix Administrator's Guide* for your operating system.) Allocate a chunk, associating it with this raw device, as your *IBM Informix Administrator's Reference* describes. Then create a dbspace with this same chunk as the initial and only chunk. When you create a high-use table, place the table in this dbspace.

Using multiple disks

You can use multiple disks for dbspaces, logical logs, temporary tables, and sort files.

Using multiple disks for a dbspace

Using multiple disks for a dbspace helps to distribute I/O across dbspaces that contain several small tables.

A dbspace can include multiple chunks, and each chunk can represent a different disk. The maximum size for a chunk is 4 terabytes. This arrangement allows you to distribute data in a dbspace over multiple disks. Figure 6-3 shows a dbspace distributed over three disks.

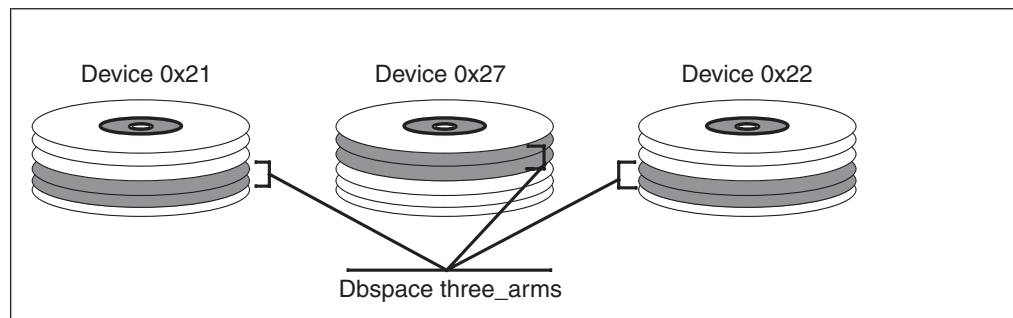

Figure 6-3. A dbspace distributed over three disks

Because you cannot use this type of distributed dbspace for parallel database queries (PDQ), you should use the table-fragmentation techniques described in "Distribution schemes" on page 9-6 to partition large, high-use tables across multiple dbspaces.

Using multiple disks for logical logs

You can distribute logical logs in different dbspaces on multiple disks in round-robin fashion to improve logical backup performance. This scheme allows the database server to back up logs on one disk, while performing logging operations on the other disks.

Keep your logical logs and the physical log on separate devices to improve performance by decreasing I/O contention on a single device. The logical and physical logs are created in the root dbspace when the database server is initialized. After initialization, you can move them to other dbspaces.

Spreading temporary tables and sort files across multiple disks

You can spread the I/O associated with temporary tables and sort files across multiple disks, after defining dbspaces for temporary tables and sort files. This can improve performance for applications that require a large amount of temporary space for temporary tables or large sort operations.

To define several dbspaces for temporary tables and sort files, use **onspaces -t**. When you place these dbspaces on different disks and list them in the **DBSPACETEMP** configuration parameter, you spread the I/O associated with temporary tables and sort files across multiple disks, as Figure 6-4 illustrates. You can list dbspaces that contain regular tables in **DBSPACETEMP**.

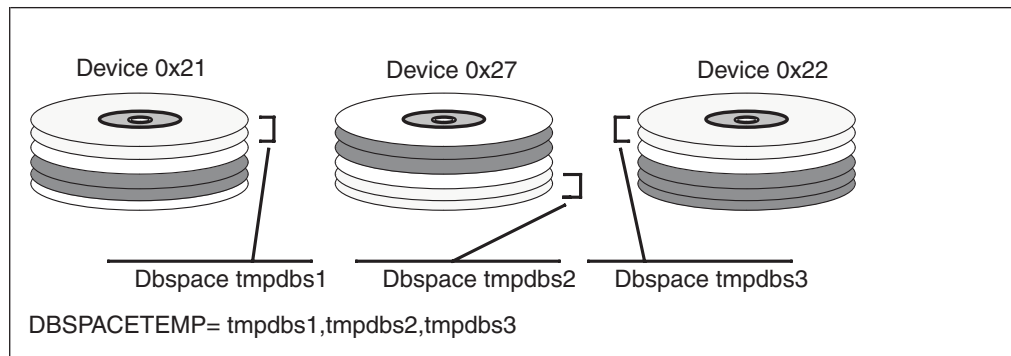

Figure 6-4. Dbspaces for temporary tables and sort files

Users can specify their own lists of dbspaces for temporary tables and sort files with the **DBSPACETEMP** environment variable. For details, see “Configure dbspaces for temporary tables and sort files” on page 5-8.

Backup and restore considerations

When you decide where to place your tables or fragments, remember that if a device that contains a dbspace fails, all tables or table fragments in that dbspace are rendered inaccessible, even though tables and fragments in other dbspaces are accessible. The need to limit data unavailability in the event of a disk failure might influence which tables you group together in a particular dbspace.

Although you must perform a cold restore if a dbspace that contains critical data fails, you need only perform a warm restore if a noncritical dbspace fails. The desire to minimize the impact of cold restores might influence the dbspace that you use to store critical data. For more information, see the *IBM Informix Backup and Restore Guide*.

Factors affecting the performance of nonfragmented tables and table fragments

Numerous factors affect the performance of an individual table or table fragment. These include the placement of the table or fragment, the size of the table or fragment, the indexing strategy that was used, the size and placement of table extents with respect to one another, and the frequency of access to the table.

Estimating table size

You can calculate the approximate sizes (in disk pages) of tables.

For a description of size calculations for indexes, see “Estimating index pages” on page 7-3.

The disk pages allocated to a table are collectively referred to as a *tblspace*. The *tblspace* includes data pages. A separate *tblspace* includes index pages. If simple large objects (TEXT or BYTE data) are associated with a table that is not stored in an alternative *dbspace*, pages that hold simple large objects are also included in the *tblspace*.

The *tblspace* does not correspond to any fixed region within a *dbspace*. The data extents and indexes that make up a table can be scattered throughout the *dbspace*.

The size of a table includes all the pages within the *tblspace*: data pages and pages that store simple large objects. Blobpages that are stored in a separate *blobospace* or on an optical subsystem are not included in the *tblspace* and are not counted as part of the table size. The following sections describe how to estimate the page count for each type of page within the *tblspace*.

Tip: If an appropriate sample table already exists, or if you can build a sample table of realistic size with simulated data, you do not need to make estimates. You can run `oncheck -pt` to obtain exact numbers.

Estimating data pages

How you estimate the data pages of a table depends on whether that table contains fixed-length or variable-length rows.

Estimating tables with fixed-length rows

You can estimate the size (in pages) of a table with fixed-length rows. A table with fixed-length rows has no columns of the VARCHAR or NVARCHAR data type.

Perform the following steps to estimate the size (in pages) of a table with fixed-length rows.

To estimate the page size, row size, number of rows, and number of data pages:

1. Use `onstat -b` to obtain the size of a page.
The **buffer size** field in the last line of this output displays the page size.
2. Subtract 28 from this amount to account for the header that appears on each data page. The resulting amount is referred to as *pageuse*.
3. To calculate the size of a row, add the widths of all the columns in the table definition. TEXT and BYTE columns each use 56 bytes. If you have already created your table, you can use the following SQL statement to obtain the size of a row:

```
SELECT rowsize FROM systables WHERE tablename =
      'table-name';
```

4. Estimate the number of rows that the table is expected to contain. This number is referred to as *rows*. The procedure for calculating the number of data pages that a table requires differs depending on whether the row size is less than or greater than *pageuse*.
5. If the size of the row is less than or equal to *pageuse*, use the following formula to calculate the number of data pages. The **trunc()** function notation indicates that you are to round down to the nearest integer.

$$\text{data_pages} = \text{rows} / \text{trunc}(\text{pageuse}/(\text{rowsize} + 4))$$

The maximum number of rows per page is 255, regardless of the size of the row.

Important: Although the maximum size of a row that the database server accepts is approximately 32 kilobytes, performance degrades when a row exceeds the size of a page. For information about breaking up wide tables for improved performance, see “Denormalize the data model to improve performance” on page 6-39.

6. If the size of the row is greater than *pageuse*, the database server divides the row between pages. The page that contains the initial portion of a row is called the *home page*. Pages that contains subsequent portions of a row are called *remainder pages*. If a row spans more than two pages, some of the remainder pages are completely filled with data from that row. When the trailing portion of a row uses less than a page, it can be combined with the trailing portions of other rows to fill out the partial remainder page. The number of data pages is the sum of the home pages, the full remainder pages, and the partial remainder pages.

- a. Calculate the number of home pages.

The number of home pages is the same as the number of rows:

$$\text{homepages} = \text{rows}$$

- b. Calculate the number of full remainder pages.

First calculate the size of the row remainder with the following formula:

$$\text{remsize} = \text{rowsize} - (\text{pageuse} + 8)$$

If *remsize* is less than *pageuse* - 4, you have no full remainder pages.

If *remsize* is greater than *pageuse* - 4, use *remsize* in the following formula to obtain the number of full remainder pages:

$$\text{fullrempages} = \text{rows} * \text{trunc}(\text{remsize}/(\text{pageuse} - 8))$$

- c. Calculate the number of partial remainder pages.

First calculate the size of a partial row remainder left after you have accounted for the home and full remainder pages for an individual row. In the following formula, the **remainder()** function notation indicates that you are to take the remainder after division:

$$\text{partremsize} = \text{remainder}(\text{rowsize}/(\text{pageuse} - 8)) + 4$$

The database server uses certain size thresholds with respect to the page size to determine how many partial remainder pages to use. Use the following formula to calculate the ratio of the partial remainder to the page:

$$\text{partratio} = \text{partremsize}/\text{pageuse}$$

Use the appropriate formula in the following table to calculate the number of partial remainder pages.

partratio Value	Formula to Calculate the Number of Partial Remainder Pages
Less than .1	$\text{partrempages} = \text{rows} / (\text{trunc}(\text{pageuse} / 10) / \text{remsize} + 1)$
Less than .33	$\text{partrempages} = \text{rows} / (\text{trunc}(\text{pageuse} / 3) / \text{remsize} + 1)$
.33 or larger	$\text{partrempages} = \text{rows}$

d. Add up the total number of pages with the following formula:

$$\text{tablesize} = \text{homepages} + \text{fullrempages} + \text{partrempages}$$

Estimating tables with variable-length rows

You can estimate the size of a table with variable-length rows with columns of the VARCHAR or NVARCHAR data type.

When a table contains one or more VARCHAR or NVARCHAR columns, its rows can have varying lengths. These varying lengths introduce uncertainty into the calculations. You must form an estimate of the typical size of each VARCHAR column, based on your understanding of the data, and use that value when you make the estimates.

Important: When the database server allocates space to rows of varying size, it considers a page to be full when no room exists for an additional row of the maximum size.

To estimate the size of a table with variable-length rows, you must make the following estimates and choose a value between them, based on your understanding of the data:

- The maximum size of the table, which you calculate based on the maximum width allowed for all VARCHAR or NVARCHAR columns
- The projected size of the table, which you calculate based on a typical width for each VARCHAR or NVARCHAR column

To estimate the maximum number of data pages:

1. To calculate *rowsize*, add together the maximum values for all column widths.
2. Use this value for *rowsize* and perform the calculations described in “Estimating tables with fixed-length rows” on page 6-5. The resulting value is called *maxsize*.

To estimate the projected number of data pages:

1. To calculate *rowsize*, add together typical values for each of your variable-width columns. It is suggested that you use the most frequently occurring width within a column as the typical width for that column. If you do not have access to the data or do not want to tabulate widths, you might choose to use some fractional portion of the maximum width, such as 2/3 (.67).
2. Use this value for *rowsize* and perform the calculations described in “Estimating tables with fixed-length rows” on page 6-5. The resulting value is called *projsize*.

Selecting an intermediate value for the size of the table

The actual table size should fall somewhere between the projected number of data pages (*projsize*) and the maximum number of data pages (*maxsize*).

Based on your knowledge of the data, choose a value within that range that seems most reasonable to you. The less familiar you are with the data, the more conservative (higher) your estimate should be.

Estimating pages that simple large objects occupy

You can estimate the total number of pages for all simple large objects, or you can estimate the number of pages based on the median size of the simple large objects.

The blobpages can reside in either the dbspace where the table resides or in a blobspace. For more information about when to use a blobspace, see “Storing simple large objects in the tblspace or a separate blobspace.”

The following methods for estimating blobpages yield a conservative (high) estimate because a single TEXT or BYTE column does not necessarily occupy the entire blobpage within a tblspace. In other words, a blobpage in a tblspace can contain multiple TEXT or BYTE columns.

To estimate the number of blobpages:

1. Obtain the page size with **onstat -b**.
2. Calculate the usable portion of the blobpage with the following formula:
$$bpuse = pagesize - 32$$
3. For each byte of blobsize n , calculate the number of pages that the byte occupies ($bpages_n$) with the following formula:
$$bpages1 = \text{ceiling}(bytesize1/bpuse)$$
$$bpages2 = \text{ceiling}(bytesize2/bpuse)$$
$$\dots$$
$$bpages_n = \text{ceiling}(bytesize_n/bpuse)$$

The **ceiling()** function indicates that you should round up to the nearest integer value.
4. Add up the total number of pages for all simple large objects, as follows:
$$blobpages = bpages1 + bpages2 + \dots + bpagesn$$

Alternatively, you can base your estimate on the median size of simple large objects (TEXT or BYTE data); that is, the simple-large-object data size that occurs most frequently. This method is less precise, but it is easier to calculate.

To estimate the number of blobpages based on the median size of simple large objects:

1. Calculate the number of pages required for simple large objects of median size, as follows:
$$mpages = \text{ceiling}(mblobsize/bpuse)$$
2. Multiply this amount by the total number of simple large objects, as follows:
$$blobpages = blobcount * mpages$$

Storing simple large objects in the tblspace or a separate blobspace

When you create a simple-large-object column on magnetic disk, you have the option of storing the column data in the tblspace or in a separate blobspace. You can often improve performance by storing simple-large-object data in a separate blobspace, and by storing smart large objects and user-defined data in sbspaces.

You can also store simple large objects on optical media, but this discussion does not apply to simple large objects stored in this way.

In the following example, a TEXT value is stored in the tblspace, and a BYTE value is stored in a blobspace named **rasters**:

```

CREATE TABLE examptab
(
  pic_id SERIAL,
  pic_desc TEXT IN TABLE,
  pic_raster BYTE IN rasters
)

```

For information about storing simple-large-object data in a separate blobspace, see “Estimating pages that simple large objects occupy” on page 6-8.

A TEXT or BYTE value is always stored apart from the rows of the table; only a 56-byte descriptor is stored with the row. However, a simple large object occupies at least one disk page. The simple large object to which the descriptor points can reside in the same set of extents on disk as the table rows (in the same tblspace) or in a separate blobspace.

When simple large objects are stored in the tblspace, the pages of their data are interspersed among the pages that contain rows, which can greatly increase the size of the table. When the database server reads only the rows and not the simple large objects, the disk arm must move farther than when the blobpages are stored apart. The database server scans only the row pages in the following situations:

- When it performs any SELECT operation that does not retrieve a simple-large-object column
- When it uses a filter expression to test rows

Another consideration is that disk I/O to and from a dbspace is buffered in shared memory of the database server. Pages are stored in case they are needed again soon, and when pages are written, the requesting program can continue before the actual disk write takes place. However, because blobspace data is expected to be voluminous, disk I/O to and from blobspaces is not buffered, and the requesting program is not allowed to proceed until all output has been written to the blobspace.

For best performance, store a simple-large-object column in a blobspace in either of the following circumstances:

- When single data items are larger than one or two pages each
- When the number of pages of TEXT or BYTE data is more than half the number of pages of row data

Estimating tblspace pages for simple large objects

In your estimate of the space required for a table, include blobpages for any simple large objects that are to be stored in that tblspace. For a table that is both relatively small and nonvolatile, you can achieve the effect of a dedicated blobspace by separating row pages and blobpages.

To separate row pages from blobpages within a dbspace:

1. Load the entire table with rows in which the simple-large-object columns are null.
2. Create all indexes. The row pages and the index pages are now contiguous.
3. Update all the rows to install the simple large objects. The blobpages now appear after the pages of row and index data within the tblspace.

Managing the size of first and next extents for the tblspace tblspace

The tblspace **tblspace** is a collection of pages that describe the location and structure of all tblspaces in a dbspace. Each dbspace has one tblspace **tblspace**. When you create a dbspace, you can use the TBLTBLFIRST and TBLTBLNEXT configuration parameters to specify the first and next extent sizes for the tblspace **tblspace** in a root dbspace.

You can use the **onspaces** utility to specify the initial and next extent sizes for the tblspace **tblspace** in non-root dbspaces.

Specify the initial and next extent sizes if you want to reduce the number of tblspace **tblspace** extents and reduce the frequency of situations when you need to place the tblspace **tblspace** extents in non-primary chunks.

The ability to specify a first extent size that is larger than the default provides flexibility for managing space. When you create an extent, you can reserve space during creation of the dbspace, thereby decreasing the risk of needing additional extents created in chunks that are not initial chunks.

You can only specify the first and next extent sizes when you create a dbspace. You cannot alter the specification of the first and next extents sizes after the creation of the dbspace. In addition, you cannot specify extent sizes for temporary dbspaces, sbspaces, blobspaces, or external spaces.

If you do not specify first and next extent sizes for the tblspace **tblspace**, Informix uses the existing default extent sizes.

For more information about specifying first and next extent sizes for the tblspace **tblspace**, see the *IBM Informix Administrator's Guide* and the *IBM Informix Administrator's Reference*.

Managing sbspaces

An *sbspace* is a logical storage unit composed of one or more chunks that store smart large objects. You can estimate the amount of storage needed for smart large objects, improve metadata I/O, monitor sbspaces, and change storage characteristics.

Estimating pages that smart large objects occupy

In your estimate of the space required for a table, you should also consider the amount of sbspace storage for any smart large objects (such as CLOB, BLOB, or multi-representative data types) that are part of the table. An sbspace contains user-data areas and metadata areas.

CLOB and BLOB data is stored in sbpages that reside in the user-data area. The metadata area contains the smart-large-object attributes, such as average size and whether or not the smart large object is logged. For more information about sbspaces, see your *IBM Informix Administrator's Guide*.

Estimating the size of the sbspace and metadata area

The first chunk of an sbspace must have a metadata area. When you add smart large objects, the database server adds more control information to this metadata area.

If you add a chunk to the sbspace after the initial allocation, you can take one of the following actions for metadata space:

- Allocate another metadata area on the new chunk by default.

This action provides the following advantages:

- It is easier because the database server automatically calculates and allocates a new metadata area on the added chunk based on the average smart large object size
 - Distributes I/O operations on the metadata area across multiple disks
- Use the existing metadata area

If you specify the **onspaces -U** option, the database server does not allocate metadata space in the new chunk. Instead it must use a metadata area in one of the other chunks.

In addition, the database server reserves 40 percent of the user area to be used in case the metadata area runs out of space. Therefore, if the allocated metadata becomes full, the database server starts using this reserved space in the user area for additional control information.

You can let the database server calculate the size of the metadata area for you on the initial chunk and on each added chunks. However, you might want to specify the size of the metadata area explicitly, to ensure that the sbspace does not run out of metadata space and the 40 percent reserve area. You can use one of the following methods to explicitly specify the amount of metadata space to allocate:

- Specify the **AVG_LO_SIZE** tag on the **onspaces -Df** option.

The database server uses this value to calculate the size of the metadata area to allocate when the **-Ms** option is not specified. If you do not specify **AVG_LO_SIZE**, the database server uses the default value of 8 kilobytes to calculate the size of the metadata area.

- Specify the metadata area size in the **-Ms** option of the **onspaces** utility.

Use the procedure that “Sizing the metadata area manually for a new chunk” describes to estimate a value to specify in the **onspaces -Ms** option.

For information about monitoring the space usage in an sbspace and allocating more space, see the *IBM Informix Administrator's Guide*.

Sizing the metadata area manually for a new chunk

Each chunk can contain metadata, but the sum total must accommodate enough room for all LO headers (average length 570 bytes each) and the chunk free list (which lists all the free extents in the chunk).

The following procedure assumes that you know the sbspace size and need to allocate more metadata space.

To size the metadata area manually for a new chunk:

1. Use the **onstat -d** option to obtain the size of the current metadata area from the **Metadata size** field.
2. Estimate the number of smart large objects that you expect to reside in the sbspace and their average size.
3. Use the following formula to calculate the total size of the metadata area:

$$\text{Total metadata kilobytes} = (\text{LOcount} * 570) / 1024 + (\text{numchunks} * 800) + 100$$

LOcount

is the number of smart large objects that you expect to have in all sbspace chunks, including the new one.

numchunks

is the total number of chunks in the sbspace.

4. To obtain the additional required area for metadata, subtract the current metadata size that you obtained in step 1 from the value that you obtained in step 3.
5. When you add another chunk, specify in the **-Ms** option of the **onspaces -a** command the value that you obtained in step 4.

Example of calculating the metadata area for a new chunk:

This topic contains an example showing how to estimate the metadata size required for two sbspaces chunks.

Suppose the **Metadata size** field in the **onstat -d** option shows that the current metadata area is 1000 pages. If the system page size is 2048 bytes, the size of this metadata area is 2000 kilobytes, as the following calculation shows:

```
current metadata = (metadata_size * pagesize) / 1024
                  = (1000 * 2048) / 1024
                  = 2000 kilobytes
```

Suppose you expect 31,000 smart large objects in the two sbspace chunks. The following formula calculates the total size of metadata area required for both chunks, rounding up fractions:

```
Total metadata = (LOcount*570)/1024 + (numchunks*800) + 100
                 = (31,000 * 570)/1024 + (2*800) + 100
                 = 17256 + 1600 + 100
                 = 18956 kilobytes
```

To obtain the additional area that is required for metadata:

1. Subtract the current metadata size from the total metadata value.

```
Additional metadata = Total metadata - current metadata
                    = 18956 - 2000
                    = 16956 kilobytes
```

2. When you add the chunk to the sbspace, use the **-Ms** option of the **onspaces -a** command to specify a metadata area of 16,956 kilobytes.

```
% onspaces -a sbchk2 -p /dev/raw_dev1 -o 200 -Ms 16956
```

For more information about **onspaces** and **onstat -d**, see the *IBM Informix Administrator's Reference*.

Improving metadata I/O for smart large objects

The metadata pages in an sbspace contain information about the location of the smart large objects in the sbspace. Typically, these pages are read intensive. You can improve metadata I/O by redistributing it.

You can distribute I/O to these pages in one of the following ways:

- Mirror the chunks that contain metadata.
For more information about the implications of mirroring, see "Consider mirroring for critical data components" on page 5-5.
- Position the metadata pages on the fastest portion of the disk.

Because the metadata pages are the most read-intensive part of an sbspace, place the metadata pages toward the middle of the disk to minimize disk seek time. To position metadata pages, use the **-Mo** option when you create the sbspace or add a chunk with the **onspaces** utility.

- Spread metadata pages across disks.

To spread metadata pages across disks, create multiple chunks in an sbspace, with each chunk residing on a separate disk. When you add a chunk to the sbspace with the **onspaces** utility, specify the **-Ms** option to allocate pages for the metadata information.

Although the database server attempts to keep the metadata information with its corresponding data in the same chunk, it cannot guarantee that they will be together.

- Decrease the number of extents each smart large object occupies.

When a smart large object spans multiple extents, the metadata area contains a separate descriptor for each extent. To decrease the number of descriptor entries that must be read for each smart large object, specify the expected final size of the smart large object when you create the smart large object.

The database server allocates the smart large object as a single extent (if it has contiguous storage in the chunk) when you specify the final size in either of the following functions:

- The DataBlade API **mi_lo_specset_estbytes** function
- The Informix ESQL/C **ifx_lo_specset_estbytes** function

For more information about the functions to open a smart large object and to set the estimated number of bytes, see the *IBM Informix ESQL/C Programmer's Manual* and *IBM Informix DataBlade API Programmer's Guide*.

For more information about sizing extents, see "Sbspace extents" on page 5-20.

Important: For highest data availability, mirror all sbspace chunks that contain metadata.

Monitoring sbspaces

You can monitor the effectiveness of I/O operations on smart large objects. For better I/O performance, all smart large objects should be allocated in one extent to be contiguous.

For more information about sizing extents, see "Sbspace extents" on page 5-20.

Contiguity provides the following I/O performance benefits:

- Minimizes the disk-arm motion
- Requires fewer I/O operations to read the smart large object
- When doing large sequential reads, can take advantage of lightweight I/O, which reads in larger blocks of data (60 kilobytes or more, depending on your platform) in a single I/O operation

You can use the following command-line utilities to monitor the effectiveness of I/O operations on smart large objects:

- **oncheck -cS, -pe** and **-pS**
- **onstat -g smb s** option

The following sections describe how to use these utility options to monitor sbspaces. For more information about **oncheck** and **onstat**, see the *IBM Informix Administrator's Reference*.

Monitoring sbspaces with oncheck -cS

The **oncheck -cS** option checks smart-large-object extents and the sbspace partitions in the user-data area.

Figure 6-5 shows an example of the output from the **-cS** option for **s9_sbspc**.

The values in the **Sbs#**, **Chk#**, and **Seq#** columns correspond to the **Space Chunk Page** value in the **-pS** output. The **Bytes** and **Pages** columns display the size of each smart large object in bytes and pages.

To calculate the average size of smart large objects, you can total the numbers in the **Size (Bytes)** column and then divide by the number of smart large objects. In Figure 6-5, the average number of bytes allocated is 2690, as the following calculation shows:

$$\begin{aligned} \text{Average size in bytes} &= (15736 + 98 + 97 + 62 + 87 + 56) / 6 \\ &= 16136 / 6 \\ &= 2689.3 \end{aligned}$$

For information about how to specify smart large object sizes to influence extent sizes, see “Sbspace extents” on page 5-20.

```
Validating space 's9_sbspc' ...
```

Large Objects											
ID	Sbs#	Chk#	Seq#	Ref Cnt	Size (Bytes)	Alloced Pages	Extns	Creat Flags	Last Modified		
2	2	1	1	1	15736	8	1	N-N-H	Thu Jun 21 16:59:12 2007		
2	2	2	1	1	98	1	1	N-K-H	Thu Jun 21 16:59:12 2007		
2	2	3	1	1	97	1	1	N-K-H	Thu Jun 21 16:59:12 2007		
2	2	4	1	1	62	1	1	N-K-H	Thu Jun 21 16:59:12 2007		
2	2	5	1	1	87	1	1	N-K-H	Thu Jun 21 16:59:12 2007		
2	2	6	1	1	56	1	1	N-K-H	Thu Jun 21 16:59:12 2007		

Figure 6-5. **oncheck -cS** output

The **Extns** field shows the minimum extent size, in number of pages, allocated to each smart large object.

Monitoring sbspaces with oncheck -pe

The **oncheck -pe** option displays information that includes the size in pages of the chunk, the number of pages used, the number of pages that are free, and a list of all the tables in the chunk, with the initial page number and the length of the table in pages. This option also shows if smart large objects occupy contiguous space within an sbspace.

Execute **oncheck -pe** to display the following information to determine if the smart large objects occupy contiguous space within an sbspace:

- Identifies each smart large object with the term **SBL0BSpace L0**
The three values in brackets following **SBL0BSpace L0** correspond to the **Sbs#**, **Chk#**, and **Seq#** columns in the **-cS** output.
- Offset of each smart large object
- Number of disk pages (*not* sbpages) used by each smart large object

Tip: The **oncheck -pe** option provides information about sbspace use in terms of database server pages, not sbpages.

Figure 6-6 shows sample output. In this example, the **size** field shows that the first smart large object occupies eight pages. Because the **offset** field shows that the first smart large object starts at page 53 and the second smart large object starts at page 61, the first smart large object occupies contiguous pages.

Chunk Pathname	Size 1000	Used 940	Free 60
Description		Offset	Size
RESERVED PAGES		0	2
CHUNK FREELIST PAGE		2	1
s9_sbspc:'informix'.TBLSpace		3	50
SBLOBSpace LO [2,2,1]		53	8
SBLOBSpace LO [2,2,2]		61	1
SBLOBSpace LO [2,2,3]		62	1
SBLOBSpace LO [2,2,4]		63	1
SBLOBSpace LO [2,2,5]		64	1
SBLOBSpace LO [2,2,6]		65	1
...			

Figure 6-6. *oncheck -pe* output that shows contiguous space use

Monitoring sbspaces with oncheck -pS

The **oncheck -pS** option displays information about smart-large-object extents and metadata areas in sbspace partitions. If you do not specify an sbspace name on the command line, **oncheck** checks and displays the metadata for all sbspaces.

Figure 6-7 on page 6-16 shows an example of the **-pS** output for **s9_sbspc**.

To display information about smart large objects, execute the following command:

```
oncheck -pS spacename
```

The **oncheck -pS** output displays the following information for each smart large object in the sbspace:

- Space chunk page
- Size in bytes of each smart large object
- Object ID that DataBlade API and Informix ESQL/C functions use
- Storage characteristics of each smart large object

When you use **onspaces -c -S** to create an sbspace, you can use the **-Df** option to specify various storage characteristics for the smart large objects. You can use **onspaces -ch** to change attributes after the sbspace is created. The **Create Flags** field in the **oncheck -pS** output displays these storage characteristics and other attributes of each smart large object. In Figure 6-7 on page 6-16, the **Create Flags** field shows **LO_LOG** because the **LOGGING** tag was set to **ON** in the **-Df** option.

```

Space Chunk Page = [2,2,2] Object ID = 987122917
LO SW Version                4
LO Object Version           1
Created by Txid             7
Flags                       0x31 LO_LOG LO_NOKEEP_LASTACCESS_TIME LO_HIGH_INTEG
Data Type                   0
Extent Size                 -1
IO Size                     0
Created                     Thu Apr 12 17:48:35 2007
Last Time Modified          Thu Apr 12 17:48:43 2007
Last Time Accessed          Thu Apr 12 17:48:43 2007
Last Time Attributes Modified Thu Apr 12 17:48:43 2007
Ref Count                   1
Create Flags                0x31 LO_LOG LO_NOKEEP_LASTACCESS_TIME LO_HIGH_INTEG
Status Flags                0x0 LO_FROM_SERVER
Size (Bytes)                2048
Size Limit                  -1
Total Estimated Size        -1
Deleting TxId               -1
LO Map Size                 200
LO Map Last Row             -1
LO Map Extents              2
LO Map User Pages           2

```

Figure 6-7. `oncheck -pS` output

Monitoring sbspaces with `onstat -g smb`

The `onstat -g smb s` option displays sbspace attributes.

Use the `onstat -g smb s` option to display the following characteristics that affect the I/O performance of each sbspace:

- Logging status

If applications are updating temporary smart large objects, logging is not required. You can turn off logging to reduce the amount of I/O activity to the logical log, CPU utilization, and memory resources.

- Average smart-large-object size

Average size and extent size should be similar to reduce the number of I/O operations required to read in an entire smart large object. The **avg s/kb** output field shows the average smart-large-object size in kilobytes. In Figure 6-8 on page 6-17, the **avg s/kb** output field shows the value 30 kilobytes.

Specify the final size of the smart large object in either of the following functions to allocate the object as a single extent:

- The DataBlade API `mi_lo_specset_estbytes` function
- The Informix ESQL/C `ifx_lo_specset_estbytes` function

For more information about the functions to open a smart large object and to set the estimated number of bytes, see the *IBM Informix ESQL/C Programmer's Manual* and *IBM Informix DataBlade API Programmer's Guide*.

- First extent size, next extent size, and minimum extent size

The **1st sz/p**, **nxt sz/p**, and **min sz/p** output fields show these extent sizes if you set the extent tags in the `-Df` option of `onspaces`. In Figure 6-8 on page 6-17, these output fields show values of 0 and -1 because these tags are not set in `onspaces`.

```

sbnnum 7      address 2afae48
Space       : flags      nchk owner   sbname
              ----- 1    informix client
Defaults   : LO_LOG LO_KEEP_LASTACCESS_TIME

LO         : ud b/pg flags   flags    avg s/kb max lcks
              2048   0      ----- 30      -1
Ext/IO    : 1st sz/p  nxt sz/p  min sz/p  mx io sz
              4      0      0      -1

HdrCache  : max    free
              512   0

```

Figure 6-8. `onstat -g smb s` output

Changing storage characteristics of smart large objects

When you create an sbspace, but do not specify values in the `-Df` option of the `onspaces -c -S` command, you use the defaults for the storage characteristics and attributes (such as logging and buffering). After you monitor sbspaces, you might want to change the storage characteristics, logging status, lock mode, or other attributes for new smart large objects.

The database administrator or programmer can use the following methods to override these default values for storage characteristics and attributes:

- The database administrator can use one of the following `onspaces` options:
 - Specify values when the sbspace is first created with the `onspaces -c -S` command.
 - Change values after the sbspace is created with the `onspaces -ch` command.

Specify these values in the tag options of the `-Df` option of `onspaces`. For more information about the `onspaces` utility, see the *IBM Informix Administrator's Reference*.

- The database administrator can specify values in the PUT clause of the CREATE TABLE or ALTER TABLE statements.

These values override the values in the `onspaces` utility and are valid only for smart large objects that are stored in the associated column of the specific table. Other smart large objects (from columns in other tables) might also reside in this same sbspace. These other columns continue to use the storage characteristics and attributes of the sbspace that `onspaces` defined (or the default values, if `onspaces` did not define them) unless these columns also used a PUT clause to override them for a particular column.

If you do not specify the storage characteristics for a smart-large-object column in the PUT clause, they are inherited from the sbspace.

If you do not specify the PUT clause when you create a table with smart-large-object columns, the database server stores the smart large objects in the system default sbspace, which is specified by the SBSPACENAME configuration parameter in the ONCONFIG file. In this case, the storage characteristics and attributes are inherited from the SBSPACENAME sbspace.

- Programmers can use functions in the DataBlade API and Informix ESQL/C to alter storage characteristics for a smart-large-object column.

For information about the DataBlade API functions for smart large objects, see the *IBM Informix DataBlade API Programmer's Guide*. For information about the Informix ESQL/C functions for smart large objects, see the *IBM Informix ESQL/C Programmer's Manual*.

Table 6-1 summarizes the ways to alter the storage characteristics for a smart large object.

Table 6-1. Altering storage characteristics and other attributes of an sbspace

Storage Characteristic or Attribute	System Default Value	System-Specified Storage Characteristics Specified by -Df Option in onspaces Utility	Column-Level Storage Characteristics Specified by PUT clause of CREATE TABLE or ALTER TABLE	Storage Characteristics Specified by a DataBlade API Function	Storage Characteristics Specified by an ESQL/C Function
Last-access time	OFF	ACCESSTIME	KEEP ACCESS TIME, NO KEEP ACCESS TIME	Yes	Yes
Lock mode	BLOB	LOCK_MODE	No	Yes	Yes
Logging status	OFF	LOGGING	LOG, NO LOG	Yes	Yes
Data integrity	HIGH INTEG	No	HIGH INTEG, MODERATE INTEG	Yes	No
Size of extent	None	EXTENT_SIZE	EXTENT SIZE	Yes	Yes
Size of next extent	None	NEXT_SIZE	No	No	No
Minimum extent size	2 kilobytes on Windows 4 kilobytes on UNIX	MIN_EXT_SIZE	No	No	No
Size of smart large object	8 kilobytes	Average size of all smart large objects in sbspace: AVG_LO_SIZE	No	Estimated size of a particular smart large object Maximum size of a particular smart large object	Estimated size of a particular smart large object Maximum size of a particular smart large object
Buffer pool usage	ON	BUFFERING	No	LO_BUFFER and LO_NOBUFFER flags	LO_BUFFER and LO_NOBUFFER flags
Name of sbspace	SBSpace-NAME	Not in -Df option. Name specified in onspaces -S option.	Name of an existing sbspace in which a smart large object resides: PUT ... IN clause	Yes	Yes
Fragmentation across multiple sbspaces	None	No	Round-robin distribution scheme: PUT ... IN clause	Round-robin or expression-based distribution scheme	Round-robin or expression-based distribution scheme
Last-access time	OFF	ACCESSTIME	KEEP ACCESS TIME, NO KEEP ACCESS TIME	Yes	Yes

Altering smart-large-object columns

When you create or modify a table, you have several options for choosing storage characteristics and other attributes (such as logging status, buffering, and lock mode) for specific smart-large-object columns.

When you create or modify a table, you can:

- Use the values that were set when the sbspace was created. These values are specified in one of the following ways:
 - With the various tags of the **-Df** option of the **onspaces -c -S** command
 - With the system default value for any specific tag that was not specified

For guidelines to change the default storage characteristics of the **-Df** tags, see “onspaces options that affect sbspace I/O” on page 5-20.

- Use the PUT clause of the CREATE TABLE statement to specify non-default values for particular characteristics or attributes.

When you do not specify particular characteristics or attributes in the PUT clause, they default to the values set in the **onspaces -c -S** command.

Later, you can use the PUT clause of the ALTER TABLE statement to change the optional storage characteristics of these columns. Table 6-1 on page 6-18 shows which characteristics and attributes you can change.

You can use the PUT clause of the ALTER TABLE statement to perform the following actions:

- Specify the smart-large-object characteristics and storage location when you add a new column to a table.

The smart large objects in the new columns can have different characteristics than those in the existing columns.
- Change the smart-large-object characteristics of an existing column.

The new characteristics of the column apply only to new smart large objects created for that column. The characteristics of existing smart large objects remain the same.

For example, the BLOB data in the **catalog** table in the **superstores_demo** database is stored in **s9_sbspc** with logging turned off and has an extent size of 100 kilobytes. You can use the PUT clause of the ALTER TABLE statement to turn on logging and store new smart large objects in a different sbspace. For information about sbspace logging, see smart large objects in the logging chapter of your *IBM Informix Administrator's Guide*.

For information about changing sbspace extents with the CREATE TABLE statement, see “Extent sizes for smart large objects in sbspaces” on page 6-22.

For more information about CREATE TABLE and ALTER TABLE, see the *IBM Informix Guide to SQL: Syntax*.

Managing extents

As you add rows to a table, the database server allocates disk space in units called *extents*. Each extent is a block of physically contiguous pages from the dbspace. Even when the dbspace includes more than one chunk, each extent is allocated entirely within a single chunk, so that it remains contiguous.

Contiguity is important to performance. When the pages of data are contiguous, and when the database server reads the rows sequentially during read-ahead, light scans, or lightweight I/O operations, disk-arm motion is minimized. For more information about these operations, see “Sequential scans” on page 5-26, “Light scans” on page 5-26, and “Configuration parameters that affect sbspace I/O” on page 5-20.

The mechanism of extents is a compromise between the following competing requirements:

- Most dbspaces are shared among several tables.
- The size of some tables is not known in advance.
- Tables can grow at different times and different rates.
- All the pages of a table should be adjacent for best performance.

Because table sizes are not known, the database server cannot preallocate table space. Therefore, the database server adds extents only as they are needed, but all the pages in any one extent are contiguous for better performance. In addition, when the database server creates an extent that is next to the previous one, it treats both as a single extent.

Choosing table extent sizes

When you create a table, you can specify extent sizes for the data rows of a table in a dbspace and for each fragment of a fragmented table, and the smart large objects in an sbspace. The database server calculates extent sizes for smart large objects in sbspaces.

Extent sizes for tables in a dbspace

When you create a table, you can specify the size of the first extent, as well as the size of the extents to be added as the table grows. You can also modify the size of the first extent in a table in a dbspace, and you can modify the size of new subsequent extents.

The following sample SQL statement creates a table with a 512-kilobyte initial extent and 100-kilobyte added extents:

```
CREATE TABLE big_one (...column specifications...)
  IN big_space
  EXTENT SIZE 512
  NEXT SIZE 100
```

The default value for the extent size and the next-extent size is eight times the disk page size on your system. For example, if you have a 2-kilobyte page, the default length is 16 kilobytes.

You can use the ALTER TABLE statement with the MODIFY EXTENT SIZE clause to change the size of the first extent of a table in a dbspace. When you change the size of the first extent, Informix records the change in the system catalog and on the partition page, but only makes the actual change when the table is rebuilt or a new partition or fragment is created.

You might want to change the size of the first extent of a table in a dbspace in either of these situations:

- If a table was created with small first extent size and you need to keep adding a lot of next extents, the table becomes fragmented across multiple extents and the data is scattered.

- If a table was created with a first extent that is much larger than the amount of data that is stored, space is wasted.

The following example changes the size of the first extent of a table in a dbspace to 50 kilobytes:

```
ALTER TABLE customer MODIFY EXTENT SIZE 50;
```

Changes to the first extent size are recorded into the system catalog table and on the partition page on the disk. However, changes to the first extent size do not take effect immediately. Instead, whenever a change that rebuilds the table occurs, the server uses the new first extent size.

For example, if a table has a first extent size of 8 kilobytes and you use the ALTER TABLE statement to change this to 16 kilobytes, the server does not drop the current first extent and recreate it with the new size. Instead, the new first extent size of 16 kilobytes takes effect only when the server rebuilds the table after actions such as creating a cluster index on the table or detaching a fragment from the table.

If a TRUNCATE TABLE statement without the REUSE option is executed before the ALTER TABLE statement with the MODIFY EXTENT SIZE clause, there is no change in the current first extent.

Use the MODIFY NEXT SIZE clause to change the size of the next extent to be added. This change does not affect next extents that already exist.

The following example changes the size of the next extent of a table to 50 kilobytes:

```
ALTER TABLE big_one MODIFY NEXT SIZE 50;
```

The next extent sizes of the following kinds of tables do not affect performance significantly:

- A small table is defined as a table that has only one extent. If such a table is heavily used, large parts of it remain buffered in memory.
- An infrequently used table is not important to performance no matter what size it is.
- A table that resides in a dedicated dbspace always receives new extents that are adjacent to its old extents. The size of these extents is not important because, being adjacent, they perform as one large extent.

For more information about creating extents and modifying the size of extents, see the *IBM Informix Guide to SQL: Syntax*.

Avoid Creating Large Numbers of Extents

When you assign an extent size to these kinds of tables, the only consideration is to avoid creating large numbers of extents. A large number of extents causes the database server to spend extra time finding the data. In addition, an upper limit exists on the number of extents allowed. (“Considering the upper limit on extents” on page 6-23 covers this topic.)

Tips for Allocating Space for Table Extents

No upper limit exists on extent sizes except the size of the chunk. The maximum size for a chunk is 4 terabytes. When you know the final size of a table (or can

confidently predict it within 25 percent), allocate all its space in the initial extent. When tables grow steadily to unknown size, assign them next-extent sizes that let them share the dbspace with a small number of extents each.

Allocating Space for Table Extents

To allocate space for table extents:

1. Decide how to allocate space among the tables.
For example, you might divide the dbspace among three tables in the ratio 0.4:0.2:0.3 (reserving 10 percent for small tables and overhead).
2. Give each table one-fourth of its share of the dbspace as its initial extent.
3. Assign each table one-eighth of its share as its next-extent size.
4. Monitor the growth of the tables regularly with **oncheck**.

As the dbspace fills up, you might not have enough contiguous space to create an extent of the specified size. In this case, the database server allocates the largest contiguous extent that it can.

Extent sizes for table fragments

When you fragment an existing table, you might want to adjust the next-extent size because each fragment requires less space than the original, unfragmented table.

If the unfragmented table was defined with a large next-extent size, the database server uses that same size for the next-extent on *each* fragment, which results in over-allocation of disk space. Each fragment requires only a proportion of the space for the entire table.

For example, if you fragment the preceding **big_one** sample table across five disks, you can alter the next-extent size to one-fifth the original size. For more information about the ALTER TABLE statement, see the *IBM Informix Guide to SQL: Syntax*. The following example changes the next-extent size to one-fifth of the original size:

```
ALTER TABLE big_one MODIFY NEXT SIZE 2;
```

Extent sizes for smart large objects in sbspaces

When you create a table, you should use the extent size that the database server calculates for smart large objects in sbspaces. Alternatively, you can use the final size of the smart large object, as indicated by a particular function when you open the sbspace in an application program.

You can use the final size of the smart large object when you open one of the following application programs:

- *For DB-Access:* Use the DataBlade API **mi_lo_specset_estbytes** function. For more information about the DataBlade API functions to open a smart large object and set the estimated number of bytes, see the *IBM Informix DataBlade API Programmer's Guide*.
- *For ESQL/C:* Use the Informix ESQL/C **ifx_lo_specset_estbytes** function. For more information about the Informix ESQL/C functions to open a smart large object and set the estimated number of bytes, see the *IBM Informix ESQL/C Programmer's Manual*.

For more information about sizing extents, see "Sbspace extents" on page 5-20. For more information, see "Monitoring sbspaces" on page 6-13.

Monitoring active tablespaces

Monitor tablespaces to determine which tables are active. Active tables are those that a thread has currently opened.

Output from the **onstat -t** option includes the tablespace number and the following four fields.

Field Description

npages

Pages allocated to the tablespace

nused Pages used from this allocated pool

nextns Number of extents used

npdata

Number of data pages used

If a specific operation needs more pages than are available (**npages** minus **nused**), a new extent is required. If enough space is available in this chunk, the database server allocates the extent here; if not, the database server looks for space in other available chunks. If none of the chunks contains adequate contiguous space, the database server uses the largest block of contiguous space that it can find in the dbspace. Figure 6-9 shows an example of the output from this option.

Tbspaces										
n	address	flgs	ucnt	tblnum	physaddr	npages	nused	npdata	nrows	nextns
0	422528	1	1	100001	10000e	150	124	0	0	3
1	422640	1	1	200001	200004	50	36	0	0	1
54	426038	1	6	100035	1008ac	3650	3631	3158	60000	3
62	4268f8	1	6	100034	1008ab	8	6	4	60	1
63	426a10	3	6	100036	1008ad	368	365	19	612	3
64	426b28	1	6	100033	1008aa	8	3	1	6	1
193	42f840	1	6	10001b	100028	8	5	2	30	1
7 active, 200 total, 64 hash buckets										

Figure 6-9. *onstat -t* output

Monitoring the upper limit on extents and extent interleaving

You can monitor the upper limit on the number of extents. You can also check for and eliminate extent interleaving.

The maximum number of extents for a partition is 32767.

Considering the upper limit on extents

Do not allow a table to acquire a large number of extents because an upper limit exists on the number of extents allowed. Trying to add an extent after you reach the limit causes error -136 (No more extents) to follow an INSERT request.

To determine the upper limit on number of extents allowed for a table:

1. Run the following **oncheck** option to obtain the physical address of the object (table or index fragment) for which you wish to calculate extent limits.

```
oncheck -pt databasename:tablename
```

Figure 6-10 on page 6-24 shows sample output for **oncheck -pt**.

```
TBLSpace Report for stores7:wbyrne.sfe_enquiry
Physical Address 7:711
Number of special columns 18
Number of keys 0
Number of extents 65
Number of data pages 960
```

Figure 6-10. `oncheck -pt` Output

- Split the physical address of the table or index fragment into the chunk number (digits preceding the colon) and page number (last five digits to the right of the colon), and then run `oncheck -pP chunk_id page_id`.

In Figure 6-10, the **Physical Address** is 7:711. Therefore, the **chunk_id** is 7 and the **page_id** is 711 in the following `oncheck` command:

```
oncheck -pP 7:711
```

Figure 6-11 shows sample output for this command.

```
addr  stamp  nslots  flag  type  frptr  frcnt  next  prev
7:711 112686  5        2    PARTN 828    1196  0    0
slot ptr  len  flg
1    24  92  0
2    116 40  0
3    156 144 0
4    300  0  0
5    300 528 0
```

Figure 6-11. `oncheck -pP chunk# page#` output

- From the output of the `oncheck -pP`, take the number below the **frcnt** column and divide it by 8 to obtain the number of additional extents you can have for this object.

In the sample `oncheck -pP` in Figure 6-11, the **frcnt** column shows the value 1196. The following calculation shows the number of additional extents:

```
Additional_extents = trunc (frcnt / 8)
                  = trunc (1196 / 8)
                  = 149
```

- To obtain the maximum number of extents, add the value in the **Number of extents** line in the `oncheck -pt` output to the `Additional_extents` value, as the following formula shows:

```
Maximum_number_extents = Additional_extents +
                        Number_of_extents
```

In the sample `oncheck -pt` in Figure 6-10, the **Number of extents** line shows the value 65. The following calculation shows the maximum number of extents for this table:

```
Maximum_number_extents = 149 + 65 = 214
```

To help ensure that the limit is not exceeded, the database server performs the following actions:

- The database server checks the number of extents each time that it creates an extent. If the number of the extent being created is a multiple of 16, the database server automatically doubles the next-extent size for the table. Therefore, at every 16th creation, the database server doubles the next-extent size.
- When the database server creates an extent next to the previous extent, it treats both extents as a single extent.

Checking for extent interleaving

When two or more growing tables share a dbspace, extents from one tblspace can be placed between extents from another tblspace. When this situation occurs, the extents are said to be *interleaved*. Performance suffers when disk seeks for a table must span more than one extent, particularly for sequential scans.

Interleaving creates gaps between the extents of a table. Figure 6-12 shows gaps between table extents.

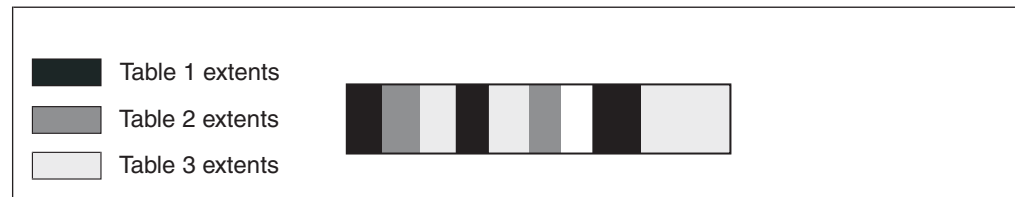

Figure 6-12. Interleaved table extents

Try to optimize the table-extent sizes to allocate contiguous disk space, which limits head movement. Also consider placing the tables in separate dbspaces.

Check periodically for extent interleaving by monitoring chunks. Execute **oncheck -pe** to obtain the physical layout of information in the chunk. The following information appears:

- Dbspace name and owner
- Number of chunks in the dbspace
- Sequential layout of tables and free space in each chunk
- Number of pages dedicated to each table extent or free space

This output is useful for determining the degree of extent interleaving. If the database server cannot allocate an extent in a chunk despite an adequate number of free pages, the chunk might be badly interleaved.

Eliminating interleaved extents

You can eliminate interleaved extents by reorganizing the tables with the UNLOAD and LOAD statements, creating or altering an index to cluster, or using the ALTER TABLE statement.

Reorganizing dbspaces and tables to eliminate extent interleaving:

You can rebuild a dbspace to eliminate interleaved extents so that the extents for each table are contiguous.

The order of the reorganized tables within the dbspace is not important, but the pages of each reorganized table should be contiguous so that no lengthy seeks are required to read the table sequentially. When the disk arm reads a table nonsequentially, it ranges only over the space that table occupies.

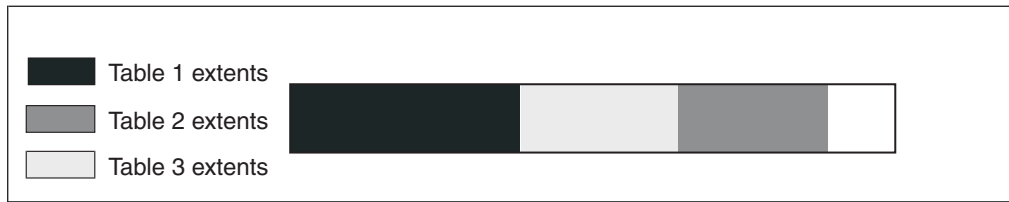

Figure 6-13. A dbspace reorganized to eliminate interleaved extents

To reorganize tables in a dbspace:

1. For DB-Access users: Copy the tables in the dbspace individually to tape with the UNLOAD statement in DB-Access.
2. Drop all the tables in the dbspace.
3. Re-create the tables with the LOAD statement or the **dbload** utility.

The LOAD statement re-creates the tables with the same properties they had before, including the same extent sizes.

You can also unload a table with the **onunload** utility and reload the table with the companion **onload** utility. For further information about selecting the correct utility or statement to use, see the *IBM Informix Migration Guide*.

Creating or altering an index to cluster:

Depending on the circumstances, you can eliminate extent interleaving if you create a clustered index or alter a clustered index. When you use the TO CLUSTER clause of the CREATE INDEX or ALTER INDEX statement, the database server sorts and reconstructs the table.

The TO CLUSTER clause reorders rows in the physical table to match the order in the index. For more information, see “Clustering” on page 7-9.

The TO CLUSTER clause eliminates interleaved extents under the following conditions:

- The chunk must contain contiguous space that is large enough to rebuild each table.
- The database server must use this contiguous space to rebuild the table.
If blocks of free space exist before this larger contiguous space, the database server might allocate the smaller blocks first. The database server allocates space for the ALTER INDEX process from the beginning of the chunk, looking for blocks of free space that are greater than or equal to the size that is specified for the next extent. When the database server rebuilds the table with the smaller blocks of free space that are scattered throughout the chunk, it does not eliminate extent interleaving.

To display the location and size of the blocks of free space, execute the **oncheck -pe** command.

To use the TO CLUSTER clause of the ALTER INDEX statement:

1. For each table in the chunk, drop all fragmented or detached indexes except the one that you want to cluster.
2. Cluster the remaining index with the TO CLUSTER clause of the ALTER INDEX statement. This step eliminates interleaving the extents when you rebuild the table by rearranging the rows.

3. Re-create all the other indexes.

You do not need to drop an index before you cluster it. However, the ALTER INDEX process is faster than CREATE INDEX because the database server reads the data rows in cluster order using the index. In addition, the resulting indexes are more compact.

To prevent the problem from recurring, consider increasing the size of the tblspace extents. For more information, see the *IBM Informix Guide to SQL: Tutorial*.

Using ALTER TABLE to eliminate extent interleaving:

If you use the ALTER TABLE statement to add or drop a column or to change the data type of a column, the database server copies and reconstructs the table. When the database server reconstructs the entire table, it rewrites the table to other areas of the dbspace. However, if other tables are in the dbspace, no guarantee exists that the new extents will be adjacent to each other.

Important: For certain types of operations that you specify in the ADD, DROP, and MODIFY clauses, the database server does not copy and reconstruct the table during the ALTER TABLE operation. In these cases, the database server uses an in-place alter algorithm to modify each row when it is updated (rather than during the ALTER TABLE operation). For more information about the conditions for this in-place alter algorithm, see “In-place alter” on page 6-33.

Reclaiming unused space within an extent

After the database server allocates disk space to a tblspace as part of an extent, that space remains dedicated to the tblspace. Even if all extent pages become empty after you delete data, the disk space remains unavailable for use by other tables unless you reclaim the space.

Important: When you delete rows in a table, the database server reuses that space to insert new rows into the same table. This section describes the procedures for reclaiming unused space for use by other tables.

You might want to resize a table that does not require the entire amount of space that was originally allocated to it. You can reallocate a smaller dbspace and release the unneeded space for other tables to use.

As the database server administrator, you can reclaim the disk space in empty extents and make it available to other users by rebuilding the table. To rebuild the table, use any of the following SQL statements:

- ALTER INDEX
- UNLOAD and LOAD
- ALTER FRAGMENT

Reclaiming space in an empty extent with ALTER INDEX

If the table with the empty extents includes an index, you can run the ALTER INDEX statement with the TO CLUSTER clause. Clustering an index rebuilds the table in a different location within the dbspace.

When you run the ALTER INDEX statement with the TO CLUSTER clause, all of the extents associated with the previous version of the table are released. Also, the newly built version of the table has no empty extents.

For more information about the syntax of the ALTER INDEX statement, see the *IBM Informix Guide to SQL: Syntax*. For more information about clustering, see "Clustering" on page 7-9.

Reclaiming space in an empty extent by unloading and re-creating or reloading a table

If the table does not include an index, you can unload the table, re-create the table (either in the same dbspace or in another one), and reload the data with the UNLOAD and LOAD statements or the **onunload** and **onload** utilities.

For further information about the **onunload** and **onload** utilities, see the *IBM Informix Migration Guide*. For more information about the syntax of the UNLOAD and LOAD statements, see the *IBM Informix Guide to SQL: Syntax*.

Releasing space in an empty extent with ALTER FRAGMENT

You can use the ALTER FRAGMENT statement to rebuild a table. When you run this statement, it releases space within the extents that were allocated to that table.

For more information about the syntax of the ALTER FRAGMENT statement, see the *IBM Informix Guide to SQL: Syntax*.

Managing extent deallocation with the TRUNCATE keyword

TRUNCATE is an SQL keyword that quickly deletes active rows from a table and the b-tree structures of its indexes, without dropping the table or its schema, access privileges, triggers, constraints, and other attributes. With this SQL data-definition language statement, you can depopulate a local table and reuse the table without re-creating it, or you can release the storage space that formerly held its data rows and b-tree structures.

Two implementations of TRUNCATE exist:

- The first implementation, called "fast truncate," operates on most tables.
- The second implementation, called "slow truncate," operates on tables that include opaque or smart large object data types, or inherited indexes that are defined on ROW types within data type hierarchies.

The performance advantages of using the TRUNCATE TABLE statement instead of the DELETE statement are much better for the fast truncate implementation, because this implementation does not examine or run all of the rows in a table. Slow truncation implementation occurs on tables that include opaque or smart large object data types or inherited indexes that are defined on ROW types within data types, because the truncate operation examines each row containing these items.

For more information about using TRUNCATE, see the *IBM Informix Guide to SQL: Syntax*.

Storing multiple table fragments in a single dbspace

You can store multiple fragments of the same table or index in a single dbspace, thus reducing the total number of dbspaces needed for a fragmented table. You must specify a name for each fragment that you want to store in the same dbspace. Storing multiple table or index fragments in a single dbspace simplifies the management of dbspaces.

You can also use this feature to improve query performance over storing each fragment in a different dbspace when a dbspace is located on a faster device.

For more information, see information about managing partitions in the *IBM Informix Administrator's Guide*.

Displaying a list of table and index partitions

Use the **onstat -g opn** option to display a list of the table and index partitions, by thread ID, that are currently open in the system.

For an example of **onstat -g opn** output and an explanation of output fields, see the *IBM Informix Administrator's Reference*.

Changing tables to improve performance

You can change tables to improve performance by dropping indexes, attaching or detaching fragments, and altering table definitions. You can also create databases for decision-support applications by unloading and loading tables in OLTP databases.

You might want to change an existing table for various reasons:

- To refresh large decision-support tables with data periodically
- To add or drop historical data from a certain time period
- To add, drop, or modify columns in large decision-support tables when the need arises for different data analysis

Loading and unloading tables

You can create databases for decision-support applications by periodically loading tables that have been unloaded from active OLTP databases.

You can use one or more of the following methods to load large tables quickly:

- High-Performance Loader (HPL)
You can use HPL in express mode to load tables quickly. For more information about how the database server performs high-performance loading, see the *IBM Informix High-Performance Loader User's Guide*.

- Nonlogging tables

The database server provides support to:

- Create nonlogging or logging tables in a logging database.
- Alter a table from nonlogging to logging and vice versa.

The two table types are STANDARD (logging tables) and RAW (nonlogging tables). You can use any loading utility such as **dbimport** or HPL to load raw tables.

- External tables

The following sections describe:

- Advantages of logging and nonlogging tables
- Step-by-step procedures to load data using nonlogging tables

For recovery information about standard and raw tables, see your *IBM Informix Administrator's Guide*.

Related tasks

 [Moving data with external tables \(Administrator's Guide\)](#)

Related reference

 [CREATE EXTERNAL TABLE Statement \(SQL Syntax\)](#)

Advantages of logging tables

Logging type options specify the logging characteristics that can improve performance in various bulk operations on the table.

STANDARD, which corresponds to a table in a logged database of previous versions, is the default logging type that is used when you issue the CREATE TABLE statement without specifying the table type.

Standard tables have the following features:

- Logging to allow rollback, recovery, and restoration from archives.
- Recovery from backups
- All insert, delete, and update operations
- Constraints to maintain the integrity of your data
- Indexes to quickly retrieve a small number of rows

OLTP applications usually use standard tables. OLTP applications typically have the following characteristics:

- Real-time insert, update, and delete transactions
Logging and recovery of these transactions is critical to preserve the data. Locking is critical to allow concurrent access and to ensure the consistency of the data selected.
- Update, insert, or delete one row or a few rows at a time
Indexes speed access to these rows. An index requires only a few I/O operations to access the pertinent row, but scanning a table to find the pertinent row might require many I/O operations.

Advantages of nonlogging tables

Nonlogging tables, which are also called raw tables, have characteristics that enable you to load very large data warehousing tables quickly.

Raw tables have following characteristics:

- They do not use CPU and I/O resources for logging.
- They avoid problems such as running out of logical-log space.
- They are locked exclusively during an express load so that no other user can access the table during the load.
- They do not support referential constraints and unique constraints, so overhead for constraint-checking is eliminated.

Quickly loading a large standard table:

You can change a large, existing standard table into a nonlogging table and then load the table.

To quickly load a large, existing standard table:

1. Drop indexes, referential constraints, and unique constraints.
2. Change the table to nonlogging.

The following sample SQL statement changes a STANDARD table to nonlogging:

```
ALTER TABLE targetab TYPE(RAW);
```

3. Load the table using a load utility such as **dbexport** or the High-Performance Loader (HPL). For more information about **dbexport** and **dbload**, see the *IBM Informix Migration Guide*. For more information about HPL, see the *IBM Informix High-Performance Loader User's Guide*.
4. Perform a level-0 backup of the nonlogging table. You must make a level-0 backup of any nonlogging table that has been modified before you convert it to STANDARD type. The level-0 backup provides a starting point from which to restore the data.
5. Change the nonlogging table to a logging table before you use it in a transaction. The following sample SQL statement changes a raw table to a standard table:

```
ALTER TABLE targetab TYPE(STANDARD);
```

Warning: Do not use nonlogging tables within a transaction where multiple users can modify the data. If you need to use a nonlogging table within a transaction, either set Repeatable Read isolation level or lock the table in exclusive mode to prevent concurrency problems.

For more information on standard tables, see the previous section, "Advantages of logging tables" on page 6-30.

6. Re-create indexes, referential constraints, and unique constraints.

Quickly loading a new nonlogging table:

You quickly create a new nonlogging table and load the table.

To quickly create and load a new, large table:

1. Create a nonlogging table in a logged database.

The following sample SQL statements create a nonlogging table:

```
CREATE DATABASE history WITH LOG;  
CONNECT TO DATABASE history;  
CREATE RAW TABLE history (...  
);
```

2. Load the table using a load utility such as **dbexport** or the High-Performance Loader (HPL). For more information about **dbexport** and **dbload**, see the *IBM Informix Migration Guide*. For more information about HPL, see the *IBM Informix High-Performance Loader User's Guide*.
3. Perform a level-0 backup of the nonlogging table.

You must make a level-0 backup of any nonlogging table that has been modified before you convert it to STANDARD type. The level-0 backup provides a starting point from which to restore the data.

4. Change the nonlogging table to a logging table before you use it in a transaction.

The following sample SQL statement changes a raw table to a standard table:

```
ALTER TABLE targetab TYPE(STANDARD);
```

Warning: Do not use nonlogging tables within a transaction where multiple users can modify the data. If you need to use a nonlogging table within a transaction, either set Repeatable Read isolation level or lock the table in exclusive mode to prevent concurrency problems.

For more information on standard tables, see the previous section, “Advantages of logging tables” on page 6-30.

5. Create indexes on columns most often used in query filters.
6. Create any referential constraints and unique constraints, if needed.

Dropping indexes for table-update efficiency

In some applications, you can confine most table updates to a single time period. You can set up your system so that all updates are applied overnight or on specified dates. When updates are performed as a batch, you can drop all nonunique indexes while you make updates and then create new indexes afterward.

This strategy can have two positive effects:

- The updating program runs much faster if it does not need to update indexes at the same time that it updates tables.
- Re-created indexes are more efficient.

For more information about when to drop indexes, see “Nonunique indexes” on page 7-10.

To load a table that has no indexes:

1. Drop the table (if it exists).
2. Create the table without specifying any unique constraints.
3. Load all rows into the table.
4. Alter the table to apply the unique constraints.
5. Create the nonunique indexes.

If you cannot guarantee that the loaded data satisfies all unique constraints, you must create unique indexes before you load the rows. You save time if the rows are presented in the correct sequence for at least one of the indexes. If you have a choice, make it the row with the largest key. This strategy minimizes the number of leaf pages that must be read and written.

Attaching or detaching fragments

You can use ALTER FRAGMENT ATTACH and DETACH statements to perform data warehouse-type operations. ALTER FRAGMENT DETACH provides a way to delete a segment of the table data rapidly. Similarly, ALTER FRAGMENT ATTACH provides a way to load large amounts of data into an existing table incrementally by taking advantage of the fragmentation technology.

For more information about how to take advantage of the performance enhancements for the ATTACH and DETACH options of the ALTER FRAGMENT statement, see “Improve the performance of operations that attach and detach fragments” on page 9-18.

Altering a table definition

The database server uses one of these algorithms to process an ALTER TABLE statement in SQL: slow alter, in-place alter, or fast alter.

Slow alter

When the database server uses the slow alter algorithm to process an ALTER TABLE statement, the table can be unavailable to other users for a long period of time.

The table might be unavailable because the database server:

- Locks the table in exclusive mode for the duration of the ALTER TABLE operation
- Makes a copy of the table in order to convert the table to the new definition
- Converts the data rows during the ALTER TABLE operation
- Can treat the ALTER TABLE statement as a long transaction and abort it if the LTXHWM threshold is exceeded

Because the database server makes a copy of the table to convert the table to the new definition, a slow alter operation requires space at least twice the size of the original table plus log space.

The database server uses the slow alter algorithm when the ALTER TABLE statement makes column changes that it cannot perform in place:

- Adding or dropping a column created with the ROWIDS keyword
- Adding or dropping a column created with the REPLCHECK keyword
- Dropping a column of the TEXT or BYTE data type
- Modifying a SMALLINT column to SERIAL, SERIAL8, or BIGSERIAL
- Converting an INT column to SERIAL, SERIAL8, or BIGSERIAL
- Modifying the data type of a column so that some possible values of the old data type cannot be converted to the new data type (For example, if you modify a column of data type INTEGER to CHAR(n), the database server uses the slow alter algorithm if the value of n is less than 11. An INTEGER requires 10 characters plus one for the minus sign for the lowest possible negative values.)
- Modifying the data type of a fragmentation column in a way that value conversion might cause rows to move to another fragment
- Adding, dropping or modifying any column when the table contains user-defined data types, smart large objects, or LVARCHAR, SET, MULTISSET, ROW, or COLLECTION data types.
- Modifying the original size or reserve specifications of VARCHAR or NVARCHAR columns.

In-place alter

The in-place alter algorithm provides numerous performance advantages over the slow alter algorithm

The in-place alter algorithm:

- Increases table availability

Other users can access the table sooner when the ALTER TABLE operation uses the in-place alter algorithm, because the database server locks the table for only the time that it takes to update the table definition and rebuild indexes that contain altered columns.

This increase in table availability can increase system throughput for application systems that require 24 by seven operations.

When the database server uses the in-place alter algorithm, it locks the table for a shorter time than the slow alter algorithm because the database server:

- Does not make a copy of the table to convert the table to the new definition
- Does not convert the data rows during the ALTER TABLE operation
- Alters the physical columns in place with the latest definition after the alter operation when you later update or insert rows. The database server converts the rows that reside on each page that you updated.
- Requires less space than the slow alter algorithm

When the ALTER TABLE operation uses the slow alter algorithm, the database server makes a copy of the table to convert the table to the new definition. The ALTER TABLE operation requires space at least twice the size of the original table plus log space.

When the ALTER TABLE operation uses the in-place alter algorithm, the space savings can be substantial for very large tables.
- Improves system throughput during the ALTER TABLE operation

The database server does not log any changes to the table data during the in-place alter operation. Not logging changes has the following advantages:

 - Log space savings can be substantial for very large tables.
 - The alter operation is not a long transaction.

Related reference

 [The ph_alert Table \(Administrator's Reference\)](#)

When the database server uses the in-place alter algorithm:

The database server uses the in-place alter algorithm for certain types of operations that you specify in the ADD, DROP, and MODIFY clauses of the ALTER TABLE statement.

The database server uses the in-place alter algorithm when you alter a table to:

- Add a column or list of columns of any data type except columns that you add with the ROWIDS keyword.
- Drop a column of any data type except TEXT or BYTE and columns created with the ROWIDS keyword.
- Add or drop a column created with the CRCOLS keyword.
- Modify a column for which the database server can convert all possible values of the old data type to the new data type.
- Modify a column that is part of the fragmentation expression if value changes do not require a row to move from one fragment to another fragment after conversion.

Important: When a table contains an extended data type, a LVARCHAR data type, a BOOLEAN data type or smart large objects, the database server does not use the in-place alter algorithm even when the column being altered contains a built-in data type.

Table 6-2 shows the conditions under which the ALTER TABLE MODIFY statement uses the in-place alter algorithm to process the ALTER TABLE MODIFY Statement.

Table 6-2. MODIFY operations and conditions that use the in-place alter algorithm

Operation on Column	Condition
Convert a SMALLINT column to an INTEGER column	All
Convert a SMALLINT column to an INT8 or BIGINT column	All

Table 6-2. MODIFY operations and conditions that use the in-place alter algorithm (continued)

Operation on Column	Condition
Convert a SMALLINT column to a DEC(p2,s2) column	p2-s2 >= 5
Convert a SMALLINT column to a DEC(p2) column	p2-s2 >= 5 OR nf
Convert a SMALLINT column to a SMALLFLOAT column	All
Convert a SMALLINT column to a FLOAT column	All
Convert a SMALLINT column to a CHAR(n) column	n >= 6 AND nf
Convert an INT column to an INT8 column	All
Convert an INT column to a DEC(p2,s2) column	p2-s2 >= 10
Convert an INT column to a DEC(p2) column	p2 >= 10 OR nf
Convert an INT column to a SMALLFLOAT column	nf
Convert an INT column to a FLOAT column	All
Convert an INT column to a CHAR(n) column	n >= 11 AND nf
Convert a SERIAL column to an INT8 column	All
Convert a SERIAL column to a DEC(p2,s2) column	p2-s2 >= 10
Convert a SERIAL column to a DEC(p2) column	p2 >= 10 OR nf
Convert a SERIAL column to a SMALLFLOAT column	nf
Convert a SERIAL column to a FLOAT column	All
Convert a SERIAL column to a CHAR(n) column	n >= 11 AND nf
Convert a SERIAL column to a SERIAL column	All
Convert a SERIAL column to a SERIAL8 or BIGSERIAL column	All
Convert a DEC(p1,s1) column to a SMALLINT column	p1-s1 < 5 AND (s1 == 0 OR nf)
Convert a DEC(p1,s1) column to an INTEGER column	p1-s1 < 10 AND (s1 == 0 OR nf)
Convert a DEC(p1,s1) column to an INT8 column	p1-s1 < 20 AND (s1 == 0 OR nf)
Convert a DEC(p1,s1) column to a SERIAL column	p1-s1 < 10 AND (s1 == 0 OR nf)
Convert a DEC(p1,s1) column to a SERIAL8 or BIGSERIAL column	p1-s1 < 20 AND (s1 == 0 OR nf)
Convert a DEC(p1,s1) column to a DEC(p2,s2) column	p2-s2 >= p1-s1 AND (s2 >= s1 OR nf)
Convert a DEC(p1,s1) column to a DEC(p2) column	p2 >= p1 OR nf
Convert a DEC(p1,s1) column to a SMALLFLOAT column	nf
Convert a DEC(p1,s1) column to a FLOAT column	nf
Convert a DEC(p1,s1) column to a CHAR(n) column	n >= 8 AND nf
Convert a DEC(p1) column to a DEC(p2) column	p2 >= p1 OR nf
Convert a DEC(p1) column to a SMALLFLOAT column	nf
Convert a DEC(p1) column to a FLOAT column	nf
Convert a DEC(p1) column to a CHAR(n) column	n >= 8 AND nf
Convert a SMALLFLOAT column to a DEC(p2) column	nf
Convert a SMALLFLOAT column to a FLOAT column	nf

Table 6-2. MODIFY operations and conditions that use the in-place alter algorithm (continued)

Operation on Column	Condition
Convert a SMALLFLOAT column to a CHAR(n) column	n >= 8 AND nf
Convert a FLOAT column to a DEC(p2) column	nf
Convert a FLOAT column to a SMALLFLOAT column	nf
Convert a FLOAT column to a CHAR(n) column	n >= 8 AND nf
Convert a CHAR(m) column to a CHAR(n) column	n >= m OR (nf AND not ANSI mode)
Increase the length of a CHARACTER column	Not ANSI mode
Increase the length of a DECIMAL or MONEY column	All

Additional information:

- The column type DEC(p) refers to non-ANSI databases in which this data type is handled as floating point.
- In ANSI databases, DEC(p) defaults to DEC(p,0) and uses the same alter algorithm as DEC(p,s).
- The condition nf indicates that the database server uses the in-place alter algorithm when the modified column is not part of the table fragmentation expression.
- The condition All indicates that the database server uses the in-place alter algorithm for all cases of the specific column operation.

Related concepts

 IBM Informix data types (Database Design and Implementation Guide)

Performance considerations for DML statements:

The database server performs additional actions if it detects any down-level version page during the execution of data manipulation language (DML) statements (INSERT, UPDATE, DELETE, SELECT). These actions can impact performance.

Each time you execute an ALTER TABLE statement that uses the in-place alter algorithm, the database server creates a new version of the table structure. The database server keeps track of all versions of table definitions. The database server resets the version status and all of the version structures and alter structures until the entire table is converted to the final format or a slow alter is performed.

If the database server detects any down-level version page during the execution of DML statements (INSERT, UPDATE, DELETE, SELECT), it performs the following actions:

- For UPDATE statements, the database server converts the entire data page or pages to the final format.
- For INSERT statements, the database server converts the inserted row to the final format and inserts it in the best-fit page. The database server converts the existing rows on the best-fit page to the final format.
- For DELETE statements, the database server does not convert the data pages to the final format.
- For SELECT statements, the database server does not convert the data pages to the final format.

If your query accesses rows that are not yet converted to the new table definition, you might notice a slight degradation in the performance of your individual query, because the database server reformats each row before it is returned.

Performance considerations for DDL statements:

In-place alter operations on data definition language (DDL) statements can impact performance. You might want to monitor outstanding in-place alters, because a large number of outstanding alters affects subsequent ALTER TABLE statements.

The **oncheck -pT *tablename*** option displays data-page versions for outstanding in-place alter operations. An in-place alter is outstanding when data pages still exist with the old definition.

Figure 6-14 displays a portion of the output that the following **oncheck** command produces after four in-place alter operations are executed on the **customer** demonstration table:

```
oncheck -pT stores_demo:customer
...
Home Data Page Version Summary

          Version          Count
          0 (oldest)         2
          1                   0
          2                   0
          3                   0
          4 (current)         0
...

```

Figure 6-14. Sample oncheck -pT output for the customer table

The **Count** field in Figure 6-14 displays the number of pages that currently use that version of the table definition. This **oncheck** output shows that four versions are outstanding:

- A value of 2 in the **Count** field for the oldest version indicates that two pages use the oldest version.
- A value of 0 in the **Count** fields for the next four versions indicates that no pages have been converted to the latest table definition.

Important: As you perform more in-place alters on a table, each subsequent ALTER TABLE statement takes more time to execute than the previous statement. Therefore, you should have no more than approximately 50 to 60 outstanding alters on a table. A large number of outstanding alters affects only the subsequent ALTER TABLE statements, but does not degrade the performance of SELECT statements.

You can convert data pages to the latest definition with a dummy UPDATE statement. For example, the following statement, which sets a column value to the existing value, causes the database server to convert data pages to the latest definition:

```
UPDATE tab1 SET col1 = col1;
```

This statement does not change any data values, but it converts the format of the data pages to the latest definition.

After an update is executed on all pages of the table, the **oncheck -pT** command displays the total number of data pages in the **Count** field for the current version of the table.

Related concepts

 [Run dummy update statements \(Migration Guide\)](#)

Alter operations that do not use the in-place alter algorithm:

The database server does not use the in-place alter algorithm when more than one algorithm is in use and when values move to another fragment.

The database server does not use the in-place alter algorithm in the following situations:

- When more than one algorithm is in use

If the ALTER TABLE statement contains more than one change, the database server uses the algorithm with the lowest performance in the execution of the statement.

For example, assume that an ALTER TABLE MODIFY statement converts a SMALLINT column to a DEC(8,2) column and converts an INTEGER column to a CHAR(8) column. The conversion of the first column is an in-place alter operation, but the conversion of the second column is a slow alter operation. The database server uses the slow alter algorithm to execute this statement.

- When values have to move to another fragment

For example, suppose you have a table with two integer columns and the following fragment expression:

```
col1 < col2 in dbspace1, remainder in dbspace2
```

If you run an ALTER TABLE MODIFY statement to convert the integer values to character values, the database server stores a row (4, 30) in **dbspace1** before the alter, but stores it in **dbspace2** after the alter operation, not as integers, 4 < 30, but as characters, "30" < "4".

Altering a column that is part of an index:

If the altered column is part of an index, the table is still altered in place, but in this case the database server rebuilds the index or indexes implicitly. If you do not need to rebuild the index, you should drop or disable it before you perform the alter operation. Taking these steps improves performance.

However, if the column that you modify is a primary key or foreign key and you want to keep this constraint, you must specify those keywords again in the ALTER TABLE statement, and the database server rebuilds the index.

For example, suppose you create tables and alter the parent table with the following SQL statements:

```
CREATE TABLE parent
  (si SMALLINT PRIMARY KEY CONSTRAINT pkey);
CREATE TABLE child
  (si SMALLINT REFERENCES parent ON DELETE CASCADE
  CONSTRAINT ckey);
INSERT INTO parent (si) VALUES (1);
INSERT INTO parent (si) VALUES (2);
INSERT INTO child (si) VALUES (1);
```

```
INSERT INTO child (si) VALUES (2);
ALTER TABLE parent
  MODIFY (si INT PRIMARY KEY CONSTRAINT pkey);
```

This ALTER TABLE example converts a SMALLINT column to an INT column. The database server retains the primary key because the ALTER TABLE statement specifies the PRIMARY KEY keywords and the **pkey** constraint. However, the database server drops any referential constraints to that primary key. Therefore, you must also specify the following ALTER TABLE statement for the child table:

```
ALTER TABLE child
  MODIFY (si int references parent on delete cascade
  constraint ckey);
```

Even though the ALTER TABLE operation on a primary key or foreign key column rebuilds the index, the database server still takes advantage of the in-place alter algorithm. The in-place alter algorithm provides the following performance benefits:

- It does not make a copy of the table in order to convert the table to the new definition.
- It does not convert the data rows during the alter operation.
- It does not rebuild all indexes on the table.

Warning: If you alter a table that is part of a view, you must re-create the view to obtain the latest definition of the table.

Fast alter

The database server uses the fast alter algorithm when the ALTER TABLE statement changes attributes of the table but does not affect the data.

The database server uses the fast alter algorithm when you use the ALTER TABLE statement to:

- Change the next-extent size.
- Add or drop a constraint.
- Change the lock mode of the table.
- Change the unique index attribute without modifying the column type.

With the fast alter algorithm, the database server holds the lock on the table for just a short time. In some cases, the database server locks the system catalog tables only to change the attribute. In either case, the table is unavailable for queries for only a short time.

Denormalize the data model to improve performance

You might need to denormalize the data model to reduce overhead and optimize performance.

The entity-relationship data model, which the *IBM Informix Guide to SQL: Tutorial* describes, produces tables that contain no redundant or derived data. According to the tenets of relational database theory, these tables are well structured.

Sometimes, to meet extraordinary demands for high performance, you might need to denormalize the data model by modifying it in ways that are undesirable from a theoretical standpoint. This section describes some modifications and their associated costs.

Shortening rows

Usually, tables with shorter rows yield better performance than those with longer rows because disk I/O is performed in pages, not in rows. The shorter the rows of a table, the more rows occur on a page. The more rows per page, the fewer I/O operations it takes to read the table sequentially, and the more likely it is that a nonsequential access can be performed from a buffer.

The entity-relationship data model puts all the attributes of one entity into a single table for that entity. For some entities, this strategy can produce rows of awkward lengths.

To shorten the rows, you can break columns into separate tables that are associated by duplicate key values in each table. As the rows get shorter, query performance should improve.

Expelling long strings

The most bulky attributes are often character strings. To make the rows shorter, you can remove long strings from the entity table.

You can use the following methods to expel long strings:

- Use VARCHAR columns.
- Use TEXT data.
- Move strings to a companion table.
- Build a symbol table.

Convert CHAR columns into VARCHAR columns to shorten rows (GLS)

A database might contain CHAR columns that you can convert to VARCHAR columns. You can use a VARCHAR column to shorten the average row length when the average length of the text string in the CHAR column is at least 2 bytes shorter than the width of the column.

VARCHAR data is immediately compatible with most existing programs, forms, and reports. You might need to recompile any forms produced by application development tools to recognize VARCHAR columns. Always test forms and reports on a sample database after you modify the table schema.

For information about other character data types, see the *IBM Informix GLS User's Guide*.

Convert a long string to a TEXT data type column

When a string fills half a disk page or more, consider converting it to a TEXT data type column in a separate blob space.

The column within the row page is only 56 bytes long, which allows more rows on a page than when you include a long string. However, the TEXT data type is not automatically compatible with existing programs. The application needed to fetch a TEXT value is a bit more complicated than the code for fetching a CHAR value into a program.

Move strings to a companion table

Strings that are less than half a page waste disk space if you treat them as TEXT data, but you can move them from the main table to a companion table.

If you split a table into two tables, the primary table and a companion table, repeat the primary key in each table.

Build a symbol table

If a column contains strings that are not unique in each row, you can move those strings to a table in which only unique copies are stored.

For example, the **customer.city** column contains city names. Some city names are repeated in the column, and most rows have some trailing blanks in the field. Using the VARCHAR data type eliminates the blanks but not the duplication.

You can create a table named **cities**, as the following example shows:

```
CREATE TABLE cities (  
    city_num SERIAL PRIMARY KEY,  
    city_name VARCHAR(40) UNIQUE  
)
```

You can change the definition of the **customer** table so that its **city** column becomes a foreign key that references the **city_num** column in the **cities** table.

To insert the city of the new customer into **cities**, you must change any program that inserts a new row into **customer**. The database server return code in the **SQLCODE** field of the SQL Communications Area (SQLCA) can indicate that the insert failed because of a duplicate key. It is not a logical error; it simply means that an existing customer is located in that city. For more information about the SQLCA, see the *IBM Informix Guide to SQL: Tutorial*.

Besides changing programs that insert data, you must also change all programs and stored queries that retrieve the city name. The programs and stored queries must use a join to the new **cities** table in order to obtain their data. The extra complexity in programs that insert rows and the extra complexity in some queries is the result of giving up theoretical correctness in the data model. Before you make the change, be sure that it returns a reasonable savings in disk space or execution time.

Splitting wide tables

Consider all the attributes of an entity that has rows that are too wide for good performance. Look for some theme or principle to divide them into two groups. Then split the table into two tables, a primary table and a companion table, repeating the primary key in each one.

The shorter rows allow you to query or update each table quickly.

Division by Bulk

One principle on which you can divide an entity table is bulk. Move the bulky attributes, which are usually character strings, to the companion table. Keep the numeric and other small attributes in the primary table. In the demonstration database, you can split the **ship_instruct** column from the **orders** table. You can call the companion table **orders_ship**. It has two columns, a primary key that is a copy of **orders.order_num** and the original **ship_instruct** column.

Division by Frequency of Use

Another principle for division of an entity is frequency of use. If a few attributes are rarely queried, move them to a companion table. In the demonstration

database, for example, perhaps only one program queries the **ship_instruct**, **ship_weight**, and **ship_charge** columns. In that case, you can move them to a companion table.

Division by Frequency of Update

Updates take longer than queries, and updating programs lock index pages and rows of data during the update process, preventing querying programs from accessing the tables. If you can separate one table into two companion tables, one with the most-updated entities and the other with the most-queried entities, you can often improve overall response time.

Performance Costs of Splitting Tables

Splitting a table uses extra disk space and adds complexity. Two copies of the primary key occur for each row, one copy in each table. Two primary-key indexes also exist. You can use the methods described in earlier sections to estimate the number of added pages.

You must modify existing programs, reports, and forms that use `SELECT *` because fewer columns are returned. Programs, reports, and forms that use attributes from both tables must perform a join to bring the tables together.

In this case, when you insert or delete a row, two tables are altered instead of one. If you do not coordinate the alteration of the two tables (by making them within a single transaction, for example), you lose semantic integrity.

Redundant data

Normalized tables contain no redundant data. Every attribute appears in only one table.

Normalized tables also contain no derived data. Instead, data that can be computed from existing attributes is selected as an expression based on those attributes.

Normalizing tables minimizes the amount of disk space used and makes updating the tables as easy as possible. However, normalized tables can force you to use joins and aggregate functions often, and those processes can be time consuming.

As an alternative, you can introduce new columns that contain redundant data, provided you understand the trade-offs involved.

Adding redundant data

A correct data model avoids redundancy by keeping any attribute only in the table for the entity that it describes. If the attribute data is needed in a different context, you join tables to make the connection. But joining takes time. If a frequently used join affects performance, you can eliminate it by duplicating the joined data in another table.

In the **stores_demo** database, the **manufact** table contains the names of manufacturers and their delivery times. An actual working database might contain many other attributes of a supplier, such as address and sales representative name.

The contents of **manufact** are primarily a supplement to the **stock** table. Suppose that a time-critical application frequently refers to the delivery lead time of a

particular product but to no other column of **manufact**. For each such reference, the database server must read two or three pages of data to perform the lookup.

You can add a new column, **lead_time**, to the **stock** table and fill it with copies of the **lead_time** column from the corresponding rows of **manufact**. That arrangement eliminates the lookup and therefore speeds up the application.

Like derived data, redundant data takes space and poses an integrity risk. In the example described in the previous paragraph, many extra copies of the lead time for each manufacturer can exist. (Each manufacturer can appear in **stock** many times.) The programs that insert or update a row of **manufact** must also update multiple rows of **stock**.

The integrity risk is simply that the redundant copies of the data might not be accurate. If a lead time is changed in **manufact**, the **stock** column is outdated until it is also updated. As you do with derived data, define the conditions under which redundant data might be wrong.

For more information about database design, see the *IBM Informix Database Design and Implementation Guide*.

Reduce disk space in tables with variable length rows

You can enable the database server to insert more rows per page into tables with variable-length rows, if you set the `MAX_FILL_DATA_PAGES` configuration parameter to 1. Allowing more variable length rows per page has advantages and disadvantages.

Potential advantages of allowing more variable length rows per page are:

- Reducing the disk space required to store data
- Enabling the server to use the buffer pool more efficiently
- Reducing table scan times

Possible disadvantages of using the `MAX_FILL_DATA_PAGES` allowing more variable length rows per page are:

- The server might store rows in a different physical order.
- As the page fills, updates made to the variable-length columns in a row could cause the row to expand so it no longer completely fits on the page. This causes the server to split the row onto two pages, increasing the access time for the row.

If the `MAX_FILL_DATA_PAGES` configuration parameter is enabled, the server will add a new row to a recently modified page with existing rows if adding the row leaves at least 10 percent of the page free for future expansion of all the rows in the page. If the `MAX_FILL_DATA_PAGES` configuration parameter is not enabled, the server will add the row only if there is sufficient room on the page to allow the new row to grow to its maximum length.

If you enable the `MAX_FILL_DATA_PAGES` configuration parameter and you want this to affect existing variable length rows, the existing tables must be reloaded.

Reduce disk space by compressing tables and fragments

You can reduce disk space by compressing and uncompressing data in tables and table fragments, consolidating free space in a table or fragment, and returning this free space to the dbSPACE. Compression is advantageous for applications with a lot of I/O activity and for applications in which the reduction of disk space usage is critical. However, if your applications run with high buffer cache hit ratios and high performance is more important than space usage, you might not want to use the compression feature, since compression might slightly decrease performance.

Compressing data, consolidating data, and returning free space have the following benefits:

- Significant savings in disk storage space
- Reduced disk usage for compressed fragments
- Significant saving of logical log usage, which saves additional space and can prevent bottlenecks for high-throughput OLTP after the compression operation is completed.
- Fewer page reads, because more rows can fit on a page
- Smaller buffer pools, because more data fits in the same size pool
- Reduced I/O activity, because:
 - More compressed rows than uncompressed rows fit on a page
 - Log records for insert, update, and delete operations of compressed rows are smaller
- Ability to compress older fragments of time-fragmented data that are not often accessed, while leaving more recent data that is frequently accessed in uncompressed form
- Ability to free space no longer needed for a table
- Faster backup and restore

Since compressed data covers fewer pages and has more rows per page than uncompressed data, the query optimizer might choose different plans after compression.

For more information, see the *IBM Informix Administrator's Guide* and the *IBM Informix Administrator's Reference*.

Chapter 7. Indexes and index performance considerations

Informix provides several types of indexes. Some performance issues are associated with indexes.

Types of indexes

Informix uses B-tree indexes, R-tree indexes, functional indexes, and indexes that DataBlade modules provide for user-defined data.

Related concepts

“What is a functional index?” on page 7-20

B-tree indexes

Informix uses a B-tree index for columns that contain built-in data types (referred to as a *traditional B-tree index*), columns that contain one-dimensional user-defined data types (referred to as a *generic B-tree index*), and values that a user-defined data type returns.

Built-in data types include character, datetime, integer, float, and so forth. For more information about built-in data types, see *IBM Informix Guide to SQL: Reference*.

User-defined data types include opaque and distinct data types. For more information about user-defined data types, see *IBM Informix User-Defined Routines and Data Types Developer's Guide*.

The return value of a user-defined function can be a built-in or user-defined data type, but not a simple large object (TEXT or BYTE data type) or a smart large object (BLOB or CLOB data type). For more information about how to use functional indexes, see “Using a functional index” on page 7-20.

For information about how to estimate B-tree index size, see “Estimating index pages” on page 7-3.

Structure of conventional index pages

A conventional index is arranged as a hierarchy of pages (technically, a *B-tree*).

The following figure shows the B-tree structure of an index. The topmost level of the hierarchy contains a single *root page*. Intermediate levels, when needed, contain *branch pages*. Each branch page contains entries that see a subset of pages in the next level of the index. The bottom level of the index contains a set of *leaf pages*. Each leaf page contains a list of index entries that see rows in the table.

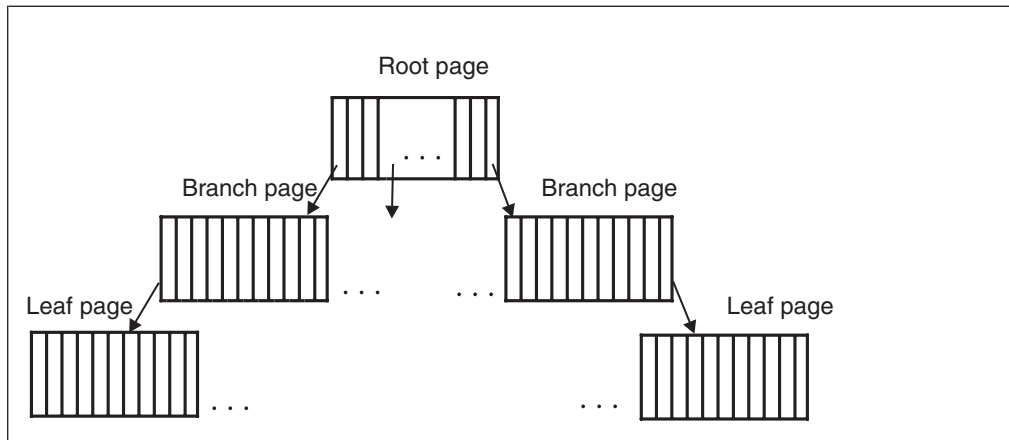

Figure 7-1. B-tree structure of an index

The number of levels needed to hold an index depends on the number of unique keys in the index and the number of index entries that each page can hold. The number of entries per page depends, in turn, on the size of the columns being indexed.

If the index page for a given table can hold 100 keys, a table of up to 100 rows requires a single index level: the root page. When this table grows beyond 100 rows, to a size between 101 and 10,000 rows, it requires a two-level index: a root page and between 2 and 100 leaf pages. When the table grows beyond 10,000 rows, to a size between 10,001 and 1,000,000 rows, it requires a three-level index: the root page, a set of 100 branch pages, and a set of up to 10,000 leaf pages.

Index entries contained within leaf pages are sorted in key-value order. An index entry consists of a *key* and one or more *row pointers*. The key is a copy of the indexed columns from one row of data. A row pointer provides an address used to locate a row that contains the key. A unique index contains one index entry for every row in the table.

For information about special indexes for Informix, see “Indexes on user-defined data types” on page 7-16.

R-tree indexes

Informix uses an R-tree index for spatial data (such as two-dimensional or three-dimensional data).

For information about sizing an R-tree index, see the *IBM Informix R-Tree Index User's Guide*.

Indexes that DataBlade modules provide

DataBlade modules can contain user-defined data types. A DataBlade module can also provide a user-defined index for the new data type.

For example, the Excalibur Text Search DataBlade provides an index to search text data. For more information, see the IBM Informix Excalibur Text Search DataBlade

For more information about the types of data and functions that each DataBlade module provides, see the user guide of each DataBlade module. For information

about how to determine the types of indexes available in your database, see “Identifying the available access methods” on page 7-18.

Estimating index pages

The index pages associated with a table can add significantly to the size of a dbspace.

By default, the database server creates the index in the same dbspace as the table, but in a separate tblspace from the table. To place the index in a separate dbspace, specify the IN keyword in the CREATE INDEX statement.

Although you cannot explicitly specify the extent size of an index, you can estimate the number of pages that an index might occupy to determine if your dbspace or dbspaces have enough space allocated.

Index extent sizes

The database server determines the extent size of an index based on the extent size for the corresponding table, regardless of whether the index is fragmented or not fragmented.

Formula for estimating the extent size of an attached index

For an attached index, the database server uses the ratio of the index key size to the row size to assign an appropriate extent size for the index.

The following formula shows how the database server uses the ratio of the index key size to the row size:

$$\text{Index extent size} = (\text{index_key_size} / \text{table_row_size}) * \text{table_extent_size}$$

In this formula:

- *index_key_size* is the total widths of the indexed column or columns plus 5 for a key descriptor.
- *table_row_size* is the sum of all the columns in the row.
- *table_extent_size* is the value that you specify in the EXTENT SIZE keyword of the CREATE TABLE statement.

If the index is not unique, then the extent size is reduced by 20 percent.

The database server also uses this same ratio for the next-extent size for the index:

$$\text{Index next extent size} = (\text{index_key_size} / \text{table_row_size}) * \text{table_next_extent_size}$$

Formula for estimating the extent size of a detached index

For a detached index, the database server uses the ratio of the index key size plus some overhead bytes to the row size to assign an appropriate extent size for the index.

The following formula shows how the database server uses the ratio of the index key size plus some overhead bytes to the row size:

$$\text{Detached Index extent size} = (\text{index_key_size} + 9) / \text{table_row_size} * \text{table_extent_size}$$

For example, suppose you have the following values:

index_key_size = 8 bytes
table_row_size = 33 bytes
table_extent_size = 150 * 2-kilobyte page

The above formula calculates the extent size as follows:

Detached Index extent size = ((8 + 9) /
33) * 150 * 2-kilobyte page
= (17/33) * 300 kilobytes
= 154 kilobytes

Important: For a non-unique index, the formula calculates an extent size that is reduced by 20 percent.

Estimating conventional index pages

You can estimate the size of index pages, using a series of formulas.

To estimate the number of index pages:

1. Add up the total widths of the indexed column or columns.

This value is referred to as *colsize*. Add 4 to *colsize* to obtain *keysize*, the actual size of a key in the index. For example, if *colsize* is 6, the value of *keysize* is 10.

2. Calculate the expected proportion of unique entries to the total number of rows.

The formulas in subsequent steps see this value as *propunique*.

If the index is unique or has few duplicate values, use 1 for *propunique*.

If a significant proportion of entries are duplicates, divide the number of unique index entries by the number of rows in the table to obtain a fractional value for *propunique*. For example, if the number of rows in the table is 4,000,000 and the number of unique index entries is 1,000,000, the value of *propunique* is .25.

If the resulting value for *propunique* is less than .01, use .01 in the calculations that follow.

3. Estimate the size of a typical index entry with one of the following formulas, depending on whether the table is fragmented or not:

- a. For nonfragmented tables, use the following formula:

$$\text{entrysize} = (\text{keysize} * \text{propunique}) + 5 + 4$$

The value 5 represents the number of bytes for the row pointer in a nonfragmented table.

For nonunique indexes, the database server stores the row pointer for each row in the index node but stores the key value only once. The *entrysize* value represents the average length of each index entry, even though some entries consist of only the row pointer.

For example, if *propunique* is .25, the average number of rows for each unique key value is 4. If *keysize* is 10, the value of *entrysize* is 11.5, calculated as $(10 * 0.25) + 5 + 4 = 2.5 + 9 = 11.5$. The following calculation shows the space required for all four rows:

$$\text{space for four rows} = 4 * 11.5 = 46$$

This space requirement is the same when you calculate it for the key value and add the four row pointers, as the following formula shows:

$$\text{space for four rows} = 10 + (4 * 9) = 46$$

- b. For fragmented tables, use the following formula:

$$\text{entrysize} = (\text{keysize} * \text{propunique}) + 9 + 4$$

The value 9 represents the number of bytes for the row pointer in a fragmented table.

4. Estimate the number of entries per index page with the following formula:
$$\text{pagents} = \text{trunc}(\text{pagefree}/\text{entrysize})$$

In this formula:

- *pagefree* is the page size minus the page header (2020 for a 2-kilobyte page size).
- *entrysize* is the size of a typical index entry, which you estimated in the previous step.

The **trunc()** function notation indicates that you should round down to the nearest integer value.

5. Estimate the number of leaf pages with the following formula:
$$\text{leaves} = \text{ceiling}(\text{rows}/\text{pagents})$$

In this formula:

- *rows* is the number of rows that you expect to be in the table.
- *pagents* is the number of entries per index page, which you estimated in the previous step.

The **ceiling()** function notation indicates that you should round up to the nearest integer value.

6. Estimate the number of branch pages at the second level of the index with the following formula:

$$\text{branches}_0 = \text{ceiling}(\text{leaves}/\text{node_ents})$$

Calculate the value for *node_ents* with the following formula:

$$\text{node_ents} = \text{trunc}(\text{pagefree} / (\text{keysize} + 4) + 4)$$

In this formula:

- *pagefree* is the page size minus the page header (2020 for a 2-kilobyte page size).
- *keysize* is the *colsize* plus 4. You obtained this value in step 1.

In the formula, 4 represents the number of bytes for the leaf node pointer.

7. If the value of *branches*₀ is greater than 1, more levels remain in the index. To calculate the number of pages contained in the next level of the index, use the following formula:

$$\text{branches}_{n+1} = \text{ceiling}(\text{branches}_n/\text{node_ents})$$

In this formula:

- *branches*_n is the number of branches for the last index level that you calculated.
- *branches*_{n+1} is the number of branches in the next level.
- *node_ents* is the value that you calculated in step 6.

8. Repeat the calculation in step 7 for each level of the index until the value of *branches*_{n+1} equals 1.
9. Add up the total number of pages for all branch levels calculated in steps 6 through 8. This sum is called *branchtotal*.
10. Use the following formula to calculate the number of pages in the compact index:

$$\text{compactpages} = (\text{leaves} + \text{branchtotal})$$

11. If your database server instance uses a fill factor for indexes, the size of the index increases.

The default fill factor value is 90 percent. You can change the fill factor value for all indexes with the FILLFACTOR configuration parameter. You can also change the fill factor for an individual index with the FILLFACTOR clause of the CREATE INDEX statement in SQL.

To incorporate the fill factor into your estimate for index pages, use the following formula:

$$\text{indexpages} = 100 * \text{compactpages} / \text{FILLFACTOR}$$

The preceding estimate is a guideline only. As rows are deleted and new ones are inserted, the number of index entries can vary within a page. This method for estimating index pages yields a conservative (high) estimate for most indexes. For a more precise value, build a large test index with real data and check its size with the **oncheck** utility.

Managing indexes

An index on the appropriate column can save thousands, tens of thousands, or in extreme cases, even millions of disk operations during a query. However, indexes entail costs.

An index is necessary on any column or combination of columns that must be unique. However, as discussed in Chapter 10, “Queries and the query optimizer,” on page 10-1, the presence of an index can also allow the query optimizer to speed up a query.

The optimizer can use an index in the following ways:

- To replace repeated sequential scans of a table with nonsequential access
- To avoid reading row data when processing expressions that name only indexed columns
- To avoid a sort (including building a temporary table) when executing the GROUP BY and ORDER BY clauses

Related concepts

“Using a functional index” on page 7-20

Space costs of indexes

The first cost of an index is disk space. The presence of an index can add many pages to a dbspace; it is easy to have as many index pages as row pages in an indexed table. Additionally, in an environment where multiple languages are used, indexes created for each language require additional disk space.

When you consider space costs, also consider whether increasing the page size of a standard or temporary dbspace is beneficial in your environment. If you want a longer key length than is available for the default page size, you can increase the page size. If you increase the page size, the size must be an integral multiple of the default page size, not greater than 16K bytes.

You might not want to increase the page size if your application contains small sized rows. Increasing the page size for an application that randomly accesses small rows might decrease performance. In addition, a page lock on a larger page will lock more rows, reducing concurrency in some situations.

For information about how to specify the page size for a standard or temporary dbspace, see the *IBM Informix Administrator's Guide*.

Time costs of indexes

The second cost of an index is time whenever the table is modified.

The following descriptions assume that approximately two pages must be read to locate an index entry. That is the case when the index consists of a root page, one level of branch pages, and a set of leaf pages. The root page is assumed to be in a buffer already. The index for a very large table has at least two intermediate levels, so about three pages are read when the database server references such an index.

Presumably, one index is used to locate a row being altered. The pages for that index might be found in page buffers in shared memory for the database server. However, the pages for any other indexes that need altering must be read from disk.

Under these assumptions, index maintenance adds time to different kinds of modifications, as the following list shows:

- When you delete a row from a table, the database server must delete its entries from all indexes.

The database server must look up the entry for the deleted row (two or three pages in) and rewrite the leaf page. The write operation to update the index is performed in memory, and the leaf page is flushed when the least recently used (LRU) buffer that contains the modified page is cleaned. This operation requires two or three page accesses to read the index pages if needed and one deferred page access to write the modified page.

- When you insert a row, the database server must insert its entries in all indexes.

The database server must find a place in which to enter the inserted row within each index (two or three pages in) and rewrite (one deferred page out), for a total of three or four immediate page accesses per index.

- When you update a row, the database server must look up its entries in each index that applies to an altered column (two or three pages in).

The database server must rewrite the leaf page to eliminate the old entry (one deferred page out) and then locate the new column value in the same index (two or three more pages in) and the row entered (one more deferred page out).

Insertions and deletions change the number of entries on a leaf page. Although virtually every *pagents* operation requires some additional work to deal with a leaf page that has either filled or been emptied, if *pagents* is greater than 100, this additional work occurs less than 1 percent of the time. You can often disregard it when you estimate the I/O impact.

In short, when a row is inserted or deleted at random, allow three to four added page I/O operations per index. When a row is updated, allow six to eight page I/O operations for each index that applies to an altered column. If a transaction is rolled back, all this work must be undone. For this reason, rolling back a transaction can take a long time.

Because the alteration of the row itself requires only two page I/O operations, index maintenance is clearly the most time-consuming part of data modification. For information about one way to reduce this cost, see “Clustering” on page 7-9.

Unclaimed index space

A background thread, the B-tree scanner, identifies an index with the most unclaimed index space. Unclaimed index space degrades performance and causes

extra work for the server. When an index is chosen for scanning, the entire leaf of the index is scanned for deleted (dirty) items that were committed, but not yet removed from the index. The B-tree scanner removes these items when necessary.

The B-tree scanner allows multiple threads.

Use the BTSCANNER configuration parameter to specify the number of B-tree scanner threads to start and the priority of the B-tree scanner threads when the database server starts. For details, see the *IBM Informix Administrator's Reference*.

You can invoke the B-tree scanner from the command line.

Indexes on columns

You can create an index for one or more columns in a table. Indexes are required on columns that must be unique and are not specified as primary keys.

In addition, you must add an index on columns that:

- Are used in joins that are not specified as foreign keys
- Are frequently used in filter expressions
- Are frequently used for ordering or grouping
- Do not involve duplicate keys
- Are amenable to clustered indexing

Filtered columns in large tables

If a column is often used to filter the rows of a large table, consider placing an index on it. The optimizer can use the index to select the wanted columns and avoid a sequential scan of the entire table.

Suppose you have a table that contains a large mailing list. If you find that a postal-code column is often used to filter a subset of rows, consider putting an index on that column.

This strategy yields a net savings of time only when the selectivity of the column is high; that is, when only a small fraction of rows holds any one indexed value. Nonsequential access through an index takes several more disk I/O operations than sequential access does, so if a filter expression on the column passes more than a fourth of the rows, the database server might as well read the table sequentially.

As a rule, indexing a filter column saves time in the following cases:

- The column is used in filter expressions in many queries or in slow queries.
- The column contains at least 100 unique values.
- Most column values appear in fewer than 10 percent of the rows.

Order-by and group-by columns

You can place an index on the ordering column or columns of a table. The database server then uses the index that to sort the query results in the most efficient manner.

When a large quantity of rows must be ordered or grouped, the database server must put the rows in order. One way that the database server performs this task is to select all the rows into a temporary table and sort the table. But, as explained in Chapter 10, "Queries and the query optimizer," on page 10-1, if the ordering

columns are indexed, the optimizer sometimes reads the rows in sorted order through the index, thus avoiding a final sort.

Because the keys in an index are in sorted sequence, the index really represents the result of sorting the table. By placing an index on the ordering column or columns, you can replace many sorts during queries with a single sort when the index is created.

Avoiding columns with duplicate keys

Duplicate keys in indexes can cause performance problems. You can take steps to avoid these problems.

When duplicate keys are permitted in an index, entries that match a given key value are grouped in lists. The database server uses these lists to locate rows that match a requested key value. When the selectivity of the index column is high, these lists are generally short. But when only a few unique values occur, the lists become long and can cross multiple leaf pages.

Placing an index on a column that has low selectivity (that is, a small number of distinct values relative to the number of rows) can reduce performance. In such cases, the database server must not only search the entire set of rows that match the key value, but it must also lock all the affected data and index pages. This process can impede the performance of other update requests as well.

To correct this problem, replace the index on the low-selectivity column with a composite index that has a higher selectivity. Use the low-selectivity column as the leading column and a high-selectivity column as your second column in the index. The composite index limits the number of rows that the database server must search to locate and apply an update.

You can use any second column to disperse the key values as long as its value does not change, or changes at the same time as the real key. The shorter the second column the better, because its values are copied into the index and expand its size.

Clustering

Clustering is a method for arranging the rows of a table so that their physical order on disk closely corresponds to the sequence of entries in the index.

(Do not confuse the clustered index with an *optical cluster*, which is a method for storing logically related TEXT or BYTE data together on an optical volume.)

When you know that a table is ordered by a certain index, you can avoid sorting. You can also be sure that when the table is searched on that column, it is read effectively in sequential order, instead of nonsequentially. These points are covered in Chapter 10, “Queries and the query optimizer,” on page 10-1.

Tip: For information about eliminating interleaved extents by altering an index to cluster, see “Creating or altering an index to cluster” on page 6-26.

In the **stores_demo** database, the **orders** table has an index, **zip_ix**, on the postal-code column. The following statement causes the database server to put the rows of the **customer** table in descending order by postal code:

```
ALTER INDEX zip_ix TO CLUSTER
```

To cluster a table on a nonindexed column, you must create an index. The following statement reorders the **orders** table by order date:

```
CREATE CLUSTER INDEX o_date_ix ON orders (order_date ASC)
```

To reorder a table, the database server must copy the table. In the preceding example, the database server reads all the rows in the table and constructs an index. Then it reads the index entries in sequence. For each entry, it reads the matching row of the table and copies it to a new table. The rows of the new table are in the desired sequence. This new table replaces the old table.

Clustering is not preserved when you alter a table. When you insert new rows, they are stored physically at the end of the table, regardless of their contents. When you update rows and change the value of the clustering column, the rows are written back into their original location in the table.

Clustering can be restored after the order of rows is disturbed by ongoing updates. The following statement reorders the table to restore data rows to the index sequence:

```
ALTER INDEX o_date_ix TO CLUSTER
```

Reclustering is usually quicker than the original clustering because reading out the rows of a nearly clustered table is similar in I/O impact to a sequential scan.

Clustering and reclustering take a lot of space and time. To avoid some clustering, build the table in the desired order initially.

Configuration parameters that affect the degree of clustering:

The **clust** field in the **sysindexes** or the **sysindices** table represents the degree of clustering of the index. The values of several configuration parameters affect the **clust** field.

The value of this field is affected by:

- The value in the **buffers** field of the BUFFERPOOL configuration parameter
- The DS_MAX_QUERIES configuration parameter, which specifies the maximum number of PDQ queries that can run concurrently

Each of these configuration parameters affects the amount of buffer space available for a single user session. Additional buffers can result in better clustering (a smaller **clust** value in the **sysindexes** or **sysindices** tables).

You can create more buffers by:

- Increasing the buffers in BUFFERPOOL
- Decreasing DS_MAX_QUERIES
- Both increasing the buffers in BUFFERPOOL and decreasing DS_MAX_QUERIES

Nonunique indexes

In some applications, most table updates can be confined to a single time period. You might be able to set up your system so that all updates are applied overnight or on specified dates. Additionally, when updates are performed as a batch, you can drop all nonunique indexes while you make updates and then create new indexes afterward. This strategy can improve performance.

Dropping nonunique indexes can have the following positive effects:

- The updating program can run faster with fewer indexes to update. Often, the total time to drop the indexes, update without them, and re-create them is less than the time to update with the indexes in place. (For a discussion of the time cost of updating indexes, see “Time costs of indexes” on page 7-7.)
- Newly made indexes are more efficient. Frequent updates tend to dilute the index structure so that it contains many partly full leaf pages. This dilution reduces the effectiveness of an index and wastes disk space.

As a time-saving measure, make sure that a batch-updating program calls for rows in the sequence that the primary-key index defines. That sequence causes the pages of the primary-key index to be read in order and only one time each.

The presence of indexes also slows down the population of tables when you use the LOAD statement or the **dbload** utility. Loading a table that has no indexes is a quick process (little more than a disk-to-disk sequential copy), but updating indexes adds a great deal of overhead.

To avoid this overhead, you can:

1. Drop the table (if it exists).
2. Create the table without specifying any unique constraints.
3. Load all rows into the table.
4. Alter the table to apply the unique constraints.
5. Create the nonunique indexes.

If you cannot guarantee that the loaded data satisfies all unique constraints, you must create unique indexes before you load the rows. It saves time if the rows are presented in the correct sequence for at least one of the indexes. If you have a choice, make it the row with the largest key. This strategy minimizes the number of leaf pages that must be read and written.

Creating and dropping an index in an online environment

You can use the CREATE INDEX ONLINE and DROP INDEX ONLINE statements to create and drop an index in an online environment, when the database and its associated tables are continuously available.

The CREATE INDEX ONLINE statement enables you to create an index without having an exclusive lock placed over the table during the duration of the index build. You can use the CREATE INDEX ONLINE statement even when reads or updates are occurring on the table. This means index creation can begin immediately.

When you create an index online, the database server logs the operation with a flag, so data recovery and restore operations can recreate the index.

When you create an index online, you can use the ONLIDX_MAXMEM configuration parameter to limit the amount of memory that is allocated to the *preimage* log pool and to the *updater* log pool in shared memory. You might want to do this if you plan to complete other operations on a table column while executing the CREATE INDEX ONLINE statement on the column. For more information about this parameter, see “Limiting memory allocation while creating indexes online” on page 7-13.

The DROP INDEX ONLINE statement enables you to drop indexes even when Dirty Read is the transaction isolation level.

The advantages of creating indexes using the CREATE INDEX ONLINE statement are:

- If a new index is needed to improve the performance of queries on a table, you can immediately create the index without a lock placed over the table.
- The database server can create an index while a table is being updated.
- The table is available for the duration of the index build.
- The query optimizer can establish better query plans, since the optimizer can update statistics in unlocked tables.

The advantages of dropping indexes using the DROP INDEX ONLINE statement are:

- You can drop an inefficient index without disturbing ongoing queries that are using that index.
- After the index is flagged, the query optimizer will not use the index for new SELECT operations on tables.

If you initiate a DROP INDEX ONLINE statement for a table that is being updated, the operation does not occur until after the table update is completed. After you issue the DROP INDEX ONLINE statement, no one can reference the index, but concurrent operations can use the index until the operations terminate. The database server waits to drop the index until all users have finished accessing the index.

An example of creating an index in an online environment is:

```
CREATE INDEX idx_1 ON table1(col1) ONLINE
```

An example of dropping an index in an online environment is:

```
DROP INDEX idx_1 ONLINE
```

For more information about the CREATE INDEX ONLINE and DROP INDEX ONLINE statements, see the *IBM Informix Guide to SQL: Syntax*.

When you cannot create or drop indexes online

You cannot use the CREATE INDEX ONLINE and the DROP INDEX ONLINE statements under certain circumstances.

You cannot use the CREATE INDEX ONLINE statement:

- To create an index at the same time that a table is being altered
- To create a clustered index
- To create a Virtual-Index Interface (VII) /R-tree index
- To create a functional index

You cannot use the DROP INDEX ONLINE statement:

- To drop a Virtual-Index Interface (VII) /R-tree index
- To drop a clustered index

Creating attached indexes in an online environment

You can create attached indexes using the `CREATE INDEX ONLINE` statement, but the statement only operates when Dirty Read is the transaction isolation level.

The index creation takes an exclusive lock on the table and waits for all other concurrent processes scanning the table to quit using the index partitions before creating the attached index. If the table is being read or updated, the `CREATE INDEX ONLINE` statement waits for the exclusive lock for the duration of the lock mode setting.

Limiting memory allocation while creating indexes online

The `ONLIDX_MAXMEM` configuration parameter limits the amount of memory that is allocated to a single *preimage* pool and a single *updater* log pool.

The preimage and updater log pools, `pimage_<partnum>` and `ulog_<partnum>`, are shared memory pools that are created when a `CREATE INDEX ONLINE` statement is executed. The pools are freed when the execution of the statement is completed.

The default value of the `ONLIDX_MAXMEM` configuration parameter is 5120 kilobytes. The minimum value that you can specify is 16 kilobytes; the maximum value is 4294967295 kilobytes.

You can set the `ONLIDX_MAXMEM` configuration parameter before starting the database server, or you can change it dynamically through the `onmode -wf` and `onmode -wm` commands.

Improving performance for index builds

You can improve performance for index builds by adjusting the PDQ priority and by allocating enough memory and temporary space for the entire index.

Whenever possible, the database server uses parallel processing to improve the response time of index builds. The number of parallel processes is based on the number of fragments in the index and the value of the `PSORT_NPROCS` environment variable. The database server builds the index with parallel processing even when the value of PDQ priority is 0.

You can often improve the performance of an index build by taking the following steps:

1. Set PDQ priority to a value greater than 0 to obtain more memory than the default 128 kilobytes.

When you set PDQ priority to greater than 0, the index build can take advantage of the additional memory for parallel processing.

To set PDQ priority, use either the `PDQPRIORITY` environment variable or the `SET PDQPRIORITY` statement in SQL.

2. Do not set the `PSORT_NPROCS` environment variable. If you have a computer with multiple CPUs, the database server uses two threads per sort when it sorts index keys and `PSORT_NPROCS` is not set. The number of sorts depends on the number of fragments in the index, the number of keys, the key size, and the values of the PDQ memory configuration parameters.
3. Allocate enough memory and temporary space to build the entire index.

- a. Estimate the amount of virtual shared memory that the database server might need for sorting.
For more information, see “Estimating memory needed for sorting.”
- b. Specify more memory with the DS_TOTAL_MEMORY and DS_MAX_QUERIES configuration parameters.
- c. If not enough memory is available, estimate the amount of temporary space needed for an entire index build.
For more information, see “Estimating temporary space for index builds.”
- d. Use the **onspaces -t** utility to create large temporary dbspaces and specify them in the DBSPACETEMP configuration parameter or the **DBSPACETEMP** environment variable.
For information about how to optimize temporary dbspaces, see “Configure dbspaces for temporary tables and sort files” on page 5-8.

Estimating memory needed for sorting

To calculate the amount of virtual shared memory that the database server might need for sorting, estimate the maximum number of sorts that might occur concurrently and multiply that number by the average number of rows and the average row size.

For example, if you estimate that 30 sorts could occur concurrently, the average row size is 200 bytes, and the average number of rows in a table is 400, you can estimate the amount of shared memory that the database server needs for sorting as follows:

$30 \text{ sorts} * 200 \text{ bytes} * 400 \text{ rows} = 2,400,000 \text{ bytes}$

You can use the DS_NONPDQ_QUERY_MEM configuration parameter to configure sort memory for all queries except those queries that have a PDQ priority of 0 (zero). The minimum and default value of DS_NONPDQ_QUERY_MEM is 128 kilobytes. The maximum supported value is 25 percent of DS_TOTAL_MEMORY. For more information, see “More memory for queries with hash joins, aggregates, and other memory-intensive elements” on page 13-33.

If the PDQ priority is greater than 0, the maximum amount of shared memory that the database server allocates for a sort is controlled by the memory grant manager (MGM). The MGM uses the settings of PDQ priority and the following configuration parameters to determine how much memory to grant for the sort:

- DS_TOTAL_MEMORY
- DS_MAX_QUERIES
- MAX_PDQPRIORITY

For more information about allocating memory for parallel processing, see “The allocation of resources for parallel database queries” on page 12-7.

Estimating temporary space for index builds

You can estimate the number of bytes of temporary space needed for an entire index build.

To estimate the amount of temporary space needed for an index build, perform the following steps:

1. Add the total widths of the indexed columns or returned values from user-defined functions. This value is referred to as *colsize*.
2. Estimate the size of a typical item to sort with one of the following formulas, depending on whether the index is attached or not:
 - a. For a nonfragmented table and a fragmented table with an index created without an explicit fragmentation strategy, use the following formula:
$$\text{sizeof_sort_item} = \text{keysize} + 4$$
 - b. For fragmented tables with the index explicitly fragmented, use the following formula:
$$\text{sizeof_sort_item} = \text{keysize} + 8$$
3. Estimate the number of bytes needed to sort with the following formula:
$$\text{temp_bytes} = 2 * (\text{rows} * \text{sizeof_sort_item})$$

This formula uses the factor 2 because everything is stored twice when intermediate sort runs use temporary space. Intermediate sort runs occur when not enough memory exists to perform the entire sort in memory.

The value for *rows* is the total number of rows that you expect to be in the table.

Storing multiple index fragments in a single dbspace

You can store multiple fragments of the same index in a single dbspace, reducing the total number of dbspaces needed for a fragmented table. You must specify a name for each fragment that you want to store in the same dbspace. Storing multiple index fragments in a single dbspace simplifies the management of dbspaces.

You can also use this feature to improve query performance over storing each fragment in a different dbspace when a dbspace is located on a faster device.

For more information, see information about managing partitions in the *IBM Informix Administrator's Guide*.

Improving performance for index checks

The **oncheck** utility provides better concurrency for tables that use row locking. When a table uses page locking, **oncheck** places a shared lock on the table when it performs index checks. Shared locks do not allow other users to perform updates, inserts, or deletes on the table while **oncheck** checks or prints the index information.

If the table uses page locking, the database server returns the following message if you run **oncheck** without the **-x** option:

```
WARNING: index check requires a s-lock on stable whose  
lock level is page.
```

For detailed information about **oncheck** locking, see the *IBM Informix Administrator's Reference*.

The following summary describes locking performed during index checks:

- By default, the database server does not place a shared lock on the table when you check an index with the **oncheck -ci**, **-cl**, **-pk**, **-pK**, **-pl**, or **-pL** options unless the table uses page locking. When **oncheck** checks indexes for a table with page

locking, it places a shared lock on the table, so no other users can perform updates, inserts, or deletes until the check has completed.

- By not placing a shared lock on tables using row locks during index checks, the **oncheck** utility cannot be as accurate in the index check. For absolute assurance of a complete index check, execute **oncheck** with the **-x** option. With the **-x** option, **oncheck** places a shared lock on the table, and no other users can perform updates, inserts, or deletes until the check completes.

You can query the **systables** system catalog table to see the current lock level of the table, as the following sample SQL statement shows:

```
SELECT locklevel FROM systables
WHERE tabname = "customer"
```

If you do not see a value of R (for row) in the **locklevel** column, you can modify the lock level, as the following sample SQL statement shows:

```
ALTER TABLE tab1 LOCK MODE (ROW);
```

Row locking might add other side effects, such as an overall increase in lock usage. For more information about locking levels, see Chapter 8, "Locking," on page 8-1.

Indexes on user-defined data types

You can define your own data types and the functions that operate on these data types. You can define indexes on some kinds of user-defined data types.

DataBlade modules also provide extended data types and functions to the database server.

You can define indexes on the following kinds of user-defined data types:

- Opaque data types

An *opaque data type* is a fundamental data type that you can use to define columns in the same way you use built-in types. An opaque data type stores a single value and cannot be divided into components by the database server. For information about creating opaque data types, see the CREATE OPAQUE TYPE statement in the *IBM Informix Guide to SQL: Syntax* and *IBM Informix User-Defined Routines and Data Types Developer's Guide*. For more information about the data types and functions that each DataBlade module provides, see the user guide of each DataBlade module.

- Distinct data types

A *distinct data type* has the same representation as an existing opaque or built-in data type but is different from these types. For information about distinct data types, see the *IBM Informix Guide to SQL: Reference* and the CREATE DISTINCT TYPE statement in the *IBM Informix Guide to SQL: Syntax*.

For more information about data types, see the *IBM Informix Guide to SQL: Reference*.

Defining indexes for user-defined data types

As with built-in data types, you might improve the response time for a query when you define indexes for new data types.

The response time for a query might improve when Informix uses an index for:

- Columns used to join two tables

- Columns that are filters for a query
- Columns in an ORDER BY or GROUP BY clause
- Results of functions that are filters for a query

For more information about when the query performance can improve with an index on a built-in data type, see “Improve performance by adding or removing indexes” on page 13-19.

Informix and DataBlade modules provide a variety of different types of indexes (also referred to as *secondary-access methods*). A secondary-access method is a set of database server functions that build, access, and manipulate an index structure. These functions encapsulate index operations, such as how to scan, insert, delete, or update nodes in an index.

To create an index on a user-defined data type, you can use any of the following secondary-access methods:

- Generic B-tree index
A B-tree index is good for a query that retrieves a range of data values. For more information, see “B-tree secondary-access method.”
- R-tree index
An R-tree index is good for searches on multidimensional data. For more information, see the *IBM Informix R-Tree Index User’s Guide*.
- Secondary-access methods that a DataBlade module provides for a new data type
A DataBlade module that supports a certain type of data can also provide a new index for that new data type. For more information, see “Using an index that a DataBlade module provides” on page 7-22.

You can create a functional index on the resulting values of a user-defined function on one or more columns. For more information, see “Using a functional index” on page 7-20.

After you choose the desired index type, you might also need to extend an operator class for the secondary-access method. For more information about how to extend operator classes, see the *IBM Informix User-Defined Routines and Data Types Developer’s Guide*.

B-tree secondary-access method

Informix provides the *generic B-tree index* for columns in database tables. In traditional relational database systems, the B-tree access method handles only built-in data types and therefore it can only compare two keys of built-in data types. The generic B-tree index is an extended version of a B-tree that Informix provides to support user-defined data types.

Tip: For more information about the structure of a B-tree index and how to estimate the size of a B-tree index, see “Estimating index pages” on page 7-3.

Informix uses the generic B-tree as the built-in secondary-access method. This built-in secondary-access method is registered in the **sysams** system catalog table with the name **btree**. When you use the CREATE INDEX statement (without the USING clause) to create an index, the database server creates a generic B-tree index. For more information, see the CREATE INDEX statement in the *IBM Informix Guide to SQL: Syntax*.

Tip: *Informix* also defines another secondary-access method, the R-tree index. For more information about how to use an R-tree index, see the *IBM Informix R-Tree Index User's Guide*.

Uses for a B-tree index:

A B-tree index is good for a query that retrieves a range of data values. If the data to be indexed has a logical sequence to which the concepts of *less than*, *greater than*, and *equal* apply, the generic B-tree index is a useful way to index your data.

Initially, the generic B-tree index supports the relational operators (<, <=, =, >=, >) on all built-in data types and orders the data in lexicographical sequence.

The optimizer considers whether to use the B-tree index to execute a query if you define a generic B-tree index on:

- Columns used to join two tables
- Columns that are filters for a query
- Columns in an ORDER BY or GROUP BY clause
- Results of functions that are filters for a query

Extending a generic B-tree index:

Initially, the generic B-tree can index data that is one of the built-in data types, and it orders the data in lexicographical sequence. However, you can extend a generic B-tree for some other data types.

You can extend a generic B-tree to support columns and functions on the following data types:

- *User-defined data types* (opaque and distinct data types) that you want the B-tree index to support
In this case, you must extend the default operator class of the generic B-tree index.
- *Built-in data types* that you want to order in a different sequence from the lexicographical sequence that the generic B-tree index uses
In this case, you must define a different operator class from the default generic B-tree index.

An *operator class* is the set of functions (operators) that are associated with a nontraditional B-tree index. For more details on operator classes, see “Choosing operator classes for indexes” on page 7-22.

Identifying the available access methods

To supplement the built-in B-tree secondary-access method that Informix provides, your enterprise might have installed DataBlade modules that implement additional secondary-access methods. If additional access methods exist, they are defined in the **sysams** system catalog table. You can query the **sysams** system catalog to determine if additional access methods are available.

To identify the secondary-access methods that are available for your database, query the **sysams** system catalog table with the following SELECT statement:

```
SELECT am_id, am_owner, am_name, am_type FROM sysams
WHERE am_type = 'S';
```

An 'S' value in the **am_type** column identifies the access method as a secondary-access method. This query returns the following information:

- The **am_id** and **am_name** columns identify the secondary-access method.
- The **am_owner** column identifies the owner of the access method.

In an ANSI-compliant database, the access-method name must be unique within the name space of the user. The access-method name always begins with the owner in the format **am_owner.am_name**.

By default, Informix provides the following definitions in the **sysams** system catalog table for two secondary-access methods, **btree** and **rtree**.

Access Method	am_id Column	am_name Column	am_owner Column
Generic B-tree	1	btree	'informix'
R-tree	2	rtree	'informix'

Important: The **sysams** system catalog table does not contain a row for the built-in primary access method. This primary access method is internal to Informix and does not require a definition in **sysams**. However, the built-in primary access method is always available for use.

If you find additional rows in the **sysams** system catalog table (rows with **am_id** values greater than 2), the database supports additional user-defined access methods. Check the value in the **am_type** column to determine whether a user-defined access method is a primary- or secondary-access method.

For more information about the columns of the **sysams** system catalog table, see the *IBM Informix Guide to SQL: Reference*. For information about how to determine the operator classes that are available in your database, see “Identifying the available operator classes” on page 7-25.

User-defined secondary-access methods

If the concepts of *less than*, *greater than*, and *equal* do not apply to the data to be indexed, you might consider using a *user-defined secondary-access method* instead of the built-in secondary-access method, which is a B-tree index. You can use a user-defined secondary-access method to access other indexing structures, such as an R-tree index.

If your database supports a user-defined secondary-access method, you can specify that the database server uses this access method when it accesses a particular index. For information about how to determine the secondary-access methods that your database defines, see “Identifying the available access methods” on page 7-18.

To choose a user-defined secondary-access method, use the USING clause of the CREATE INDEX statement. The USING clause specifies the name of the secondary-access method to use for the index you create. This name must be listed in the **am_name** column of the **sysams** system catalog table and must be a secondary-access method (the **am_type** column of **sysams** is 'S').

The secondary-access method that you specify in the USING clause of CREATE INDEX must already be defined in the **sysams** system catalog. If the secondary-access method has not yet been defined, the CREATE INDEX statement fails.

When you omit the USING clause from the CREATE INDEX statement, the database server uses B-tree indexes as the secondary-access method. For more information, see the CREATE INDEX statement in the *IBM Informix Guide to SQL: Syntax*.

R-tree indexes:

Informix supports the *R-tree index* for columns that contain spatial data such as maps and diagrams. An R-tree index uses a tree structure whose nodes store pointers to lower-level nodes.

At the leaves of the R-tree are a collection of data pages that store *n*-dimensional shapes. For more information about the structure of an R-tree index and how to estimate the size of an R-tree index, see the *IBM Informix R-Tree Index User's Guide*.

Using a functional index

You can create a column index on the actual values in one or more columns. You can also create a functional index on the values of one or more columns that a user-defined function returns from arguments.

Important: The database server imposes the following restrictions on the user-defined routines (UDRs) on which a functional index is defined:

- The arguments cannot be column values of a collection data type.
- The function cannot return a large object (including built-in types BLOB, BYTE, CLOB, and TEXT).
- The function cannot be a VARIANT function.
- The function cannot include any DML statement of SQL. .
- The function must be a UDR, rather than a built-in function. However, you can create an SPL wrapper that calls and returns the value from a built-in function of SQL.

In addition, do not create functional indexes using any routine that calls the built-in DECRYPT_BINARY() or DECRYPT_CHAR() functions, which can display encrypted data values in plain text. (Do not attempt to use data values in any encrypted column as an index key.)

To decide whether to use a column index or functional index, determine whether a column index is the right choice for the data that you want to index. An index on a column of some data types might not be useful for typical queries. For example, the following query asks how many images are dark:

```
SELECT COUNT(*) FROM photos WHERE  
darkness(picture) > 0.5
```

An index on the **picture** data itself does not improve the query performance. The concepts of *less than*, *greater than*, and *equal* are not particularly meaningful when applied to an image data type. Instead, a functional index that uses the **darkness()** function can improve performance. You might also have a user-defined function that runs frequently enough that performance improves when you create an index on its values.

Related concepts

“Managing indexes” on page 7-6

What is a functional index?:

A functional index can be a B-tree index, an R-tree index, or a user-defined index type that a DataBlade module provides.

When you create a functional index, the database server computes the values of the user-defined function and stores them as key values in the index. When a change in the table data causes a change in one of the values of an index key, the database server automatically updates the functional index.

You can use a functional index for functions that return values of both user-defined data types (opaque and distinct) and built-in data types. However, you cannot define a functional index if the function returns a simple-large-object data type (TEXT or BYTE).

For more information about the types of indexes, see “Defining indexes for user-defined data types” on page 7-16. For information about space requirements for functional indexes, see “Estimating index pages” on page 7-3.

Related concepts

“Types of indexes” on page 7-1

When is a functional index used?:

The optimizer considers whether to use a functional index to access the results of functions that are in a SELECT clause or are in the filters in the WHERE clause.

Creating a functional index:

You can build a functional index on a user-defined function. The user-defined function can be either an external function or an SPL function.

To build a functional index on a user-defined function:

1. Write the code for the user-defined function if it is an external function.
2. Register the user-defined function in the database with the CREATE FUNCTION statement.
3. Build the functional index with the CREATE INDEX statement.

For example, to create a functional index on the darkness() function:

1. Write the code for the user-defined **darkness()** function that operates on the data type and returns a decimal value.
2. Register the user-defined function in the database with the CREATE FUNCTION statement:

```
CREATE FUNCTION darkness(im image)
RETURNS decimal
EXTERNAL NAME '/lib/image.so'
LANGUAGE C NOT VARIANT
```

In this example, you can use the default operator class for the functional index because the return value of the **darkness()** function is a built-in data type, DECIMAL.

3. Build the functional index with the CREATE INDEX statement.

```
CREATE TABLE photos
(
    name char(20),
    picture image
    ...
);
CREATE INDEX dark_ix ON photos (darkness(picture));
```

In this example, assume that the user-defined data type of **image** has already been defined in the database.

The optimizer can now consider the functional index when you specify the **darkness()** function as a filter in the query:

```
SELECT count(*) FROM photos WHERE  
darkness(picture) > 0.5
```

You can also create a composite index with user-defined functions. For more information, see “Use composite indexes” on page 13-19.

Warning: Do not create a functional index using either the `DECRYPT_BINARY()` or the `DECRYPT_CHAR()` function. These functions store plain text data in the database, defeating the purpose of encryption. For more information about encryption, see the *IBM Informix Administrator's Guide*.

Using an index that a DataBlade module provides

DataBlade modules can provide new data types that users can access. A DataBlade module can also provide a new index for the new data type.

For example, the Excalibur Text Search DataBlade module provides an index to search text data. For more information, see the *Excalibur Text Search DataBlade Module User's Guide*.

For more information about the types of data and functions that each DataBlade module provides, see the user guide for the DataBlade module. For information about how to determine the types of indexes available in your database, see “Identifying the available access methods” on page 7-18.

Choosing operator classes for indexes

For most situations, use the default operators that are defined for a secondary-access method. However, when you want to order the data in a different sequence or provide index support for a user-defined data type, you must extend an operator class.

For more information about how to extend an operator class, see *IBM Informix User-Defined Routines and Data Types Developer's Guide*.

Operator classes

An *operator class* is a set of function names that is associated with a secondary-access method. These functions allow the secondary-access method to store and search for values of a particular data type.

The query optimizer for the database server uses an operator class to determine if an index can process the query with the least cost. An operator class indicates two things to the query optimizer:

- Which functions that appear in an SQL statement can be evaluated with a given index
These functions are called the *strategy functions* for the operator class.
- Which functions the index uses to evaluate the strategy functions
These functions are called the *support functions* for the operator class.

With the information that the operator class provides, the query optimizer can determine whether a given index is applicable to the query. The query optimizer can consider whether to use the index for the given query when the following conditions are true:

- An index exists on the particular column or columns in the query.
- For the index that exists, the operation on the column or columns in the query matches one of the strategy functions in the operator class associated with the index.

The query optimizer reviews the available indexes for the table or tables and matches the index keys with the column specified in the query filter. If the column in the filter matches an index key, and the function in the filter is one of the strategy functions of the operator class, the optimizer includes the index when it determines which query plan has the lowest execution cost. In this manner, the optimizer can determine which index can process the query with the least cost.

Informix stores information about operator classes in the **sysopclasses** system catalog table.

Strategy and support functions of a secondary access method:

Informix uses the *strategy functions* of a secondary-access method to help the query optimizer determine whether a specific index is applicable to a specific operation on a data type.

If an index exists and the operator in the filter matches one of the strategy functions in the operator class, the optimizer considers whether to use the index for the query.

Informix uses the *support functions* of a secondary-access method to build and access the index. These functions are not called directly by end users. When an operator in the query filter matches one of the strategy functions, the secondary-access method uses the support functions to traverse the index and obtain the results. Identification of the actual support functions is left to the secondary-access method.

Default operator classes:

Each secondary-access method has a *default operator class* associated with it. By default, the CREATE INDEX statement associates the default operator class with an index.

For example, the following CREATE INDEX statement creates a B-tree index on the **postalcode** column and automatically associates the default B-tree operator class with this column:

```
CREATE INDEX postal_ix ON customer(postalcode)
```

For more information about how to specify a new default operator class for an index, see “User-defined operator classes” on page 7-26.

Built-in B-tree operator class

The built-in secondary-access method (the generic B-tree) has a default operator class called **btree_ops**, which is defined in the **sysopclasses** system catalog table.

By default, the CREATE INDEX statement associates the **btree_ops** operator class with it when you create a B-tree index. For example, the following CREATE

INDEX statement creates a generic B-tree index on the **order_date** column of the **orders** table and associates with this index the default operator class for the B-tree secondary-access method:

```
CREATE INDEX orddate_ix ON orders (order_date)
```

Informix uses the **btree_ops** operator class to specify:

- The strategy functions to tell the query optimizer which filters in a query can use a B-tree index
- The support function to build and search the B-tree index

B-tree strategy functions:

The **btree_ops** operator class defines the names of strategy functions for the **btree** access method.

The strategy functions that the **btree_ops** operator class defines are:

- **lessthan** (<)
- **lessthanorequal** (<=)
- **equal** (=)
- **greaterthanorequal** (>=)
- **greaterthan** (>)

These strategy functions are all *operator functions*. That is, each function is associated with an operator symbol; in this case, with a relational-operator symbol. For more information about relational-operator functions, see the *IBM Informix User-Defined Routines and Data Types Developer's Guide*.

When the query optimizer examines a query that contains a column, it checks to see if this column has a B-tree index defined on it. If such an index exists *and* if the query contains one of the relational operators that the **btree_ops** operator class supports, the optimizer can choose a B-tree index to execute the query.

B-tree support function:

The **btree_ops** operator class has one support function, a comparison function called **compare()**. The **btree_ops** operator class has one support function, a comparison function called **compare()**.

The **compare()** function is a user-defined function that returns an integer value to indicate whether its first argument is equal to, less than, or greater than its second argument, as follows:

- A value of 0 when the first argument is *equal to* the second argument
- A value less than 0 when the first argument is *less than* the second argument
- A value greater than 0 when the first argument is *greater than* the second argument

The B-tree secondary-access method uses the **compare()** function to traverse the nodes of the generic B-tree index. To search for data values in a generic B-tree index, the secondary-access method uses the **compare()** function to compare the key value in the query to the key value in an index node. The result of the comparison determines if the secondary-access method needs to search the next-lower level of the index or if the key resides in the current node.

The generic B-tree access method also uses the **compare()** function to perform the following tasks for generic B-tree indexes:

- Sort the keys before the index is built
- Determine the linear order of keys in a generic B-tree index
- Evaluate the relational operators
- Search for data values in an index

The database server uses the **compare()** function to evaluate comparisons in the SELECT statement. To provide support for these comparisons for opaque data types, you must write the **compare()** function. For more information, see the *IBM Informix User-Defined Routines and Data Types Developer's Guide*.

The database server also uses the **compare()** function when it uses a B-tree index to process an ORDER BY clause in a SELECT statement. However, the optimizer does not use the index to perform an ORDER BY operation if the index does not use the **btree_ops** operator class.

Identifying the available operator classes

You can identify the operator classes that are available for your database by querying the **sysopclasses** system catalog table.

The database server provides the default operator class for the built-in secondary-access method, the generic B-tree index. In addition, your environment might have installed DataBlade modules that implement other operator classes. All operator classes are defined in the **sysopclasses** system catalog table.

To identify the operator classes that are available for your database, query the **sysopclasses** system catalog table with the following SELECT statement:

```
SELECT opclassid, opclassname, amid, am_name
FROM sysopclasses, sysams
WHERE sysopclasses.amid = sysams.am_id
```

This query returns the following information:

- The **opclassid** and **opclassname** columns identify the operator class.
- The **amid** and **am_name** columns identify the associated secondary-access methods.

By default, the database server provides the following definitions in the **sysopclasses** system catalog table for two operator classes, **btree_ops** and **rtree_ops**.

Access Method	opclassid Column	opclassname Column	amid Column	am_name Column
Generic B-tree	1	btree_ops	1	btree
R-tree	2	rtree_ops	2	rtree

If you find additional rows in the **sysopclasses** system catalog table (rows with **opclassid** values greater than 2), your database supports user-defined operator classes. Check the value in the **amid** column to determine the secondary-access methods to which the operator class belongs.

The **am_defopclass** column in the **sysams** system catalog table stores the operator-class identifier for the default operator class of a secondary-access

method. To determine the default operator class for a given secondary-access method, you can run the following query:

```
SELECT am_id, am_name, am_defopclass, opclass_name
FROM sysams, sysopclasses
WHERE sysams.am_defopclass = sysopclasses.opclassid
```

By default, the database server provides the following default operator classes.

Access Method	am_id Column	am_name Column	am_defopclass Column	opclass_name Column
Generic B-tree	1	btree	1	btree_ops
R-tree	2	rtree	2	rtree_ops

For more information about the columns of the **sysopclasses** and **sysams** system catalog tables, see the *IBM Informix Guide to SQL: Reference*. For information about how to determine the access methods that are available in your database, see “Identifying the available access methods” on page 7-18.

User-defined operator classes

The CREATE INDEX statement specifies the operator class to use for each component of an index. If you do not specify an operator class, the CREATE INDEX statement uses the default operator class for the secondary-access method that you create. You can use a user-defined operator class for components of an index.

To specify a user-defined operator class for a particular component of an index, you can:

- Use a user-defined operator class that your database already defines.
- Use an R-tree operator class, if your database defined the R-tree secondary-access method. For more information about R-trees, see the *IBM Informix R-Tree Index User’s Guide*.

If your database supports multiple-operator classes for the secondary-access method that you want to use, you can specify which operator classes the database server is to use for a particular index. For information on how to determine the operator classes that your database defines, see “Identifying the available operator classes” on page 7-25.

Each part of a composite index can specify a different operator class. You choose the operator classes when you create the index. In the CREATE INDEX statement, you specify the name of the operator class to use after each column or function name in the index-key specification. Each name must be listed in the **opclassname** column of the **sysopclasses** system catalog table and must be associated with the secondary-access method that the index uses.

For example, if your database defines the **abs_btree_ops** secondary-access method to define a new sort order, the following CREATE INDEX statement specifies that the **table1** table associates the **abs_btree_ops** operator class with the **col1_ix** B-tree index:

```
CREATE INDEX col1_ix ON table1(col1 abs_btree_ops)
```

The operator class that you specify in the CREATE INDEX statement must already be defined in the **sysopclasses** system catalog with the CREATE OPCLASS statement. If the operator class has not yet been defined, the CREATE INDEX

statement fails. For information about how to create an operator class, see *IBM Informix User-Defined Routines and Data Types Developer's Guide*.

Chapter 8. Locking

The database server uses locks, which can affect concurrency and performance. You can monitor and administer locks.

Locks

A *lock* is a software mechanism that you can set to prevent others from using a resource. You can place a lock on a single row or key, a page of data or index keys, a whole table, or an entire database.

Additional types of locks are available for smart large objects. For more information, see “Locks for smart large objects” on page 8-16.

The maximum number of rows or pages locked in a single transaction is controlled by the total number of locks configured. The number of tables in which those rows or pages are locked is not explicitly controlled.

Locking granularity

The level and type of information that the lock protects is called *locking granularity*. Locking granularity affects performance.

When a user cannot access a row or key, the user can wait for another user to unlock the row or key. If a user locks an entire page, a higher probability exists that more users will wait for a row in the page.

The ability of more than one user to access a set of rows is called *concurrency*. The goal of the database administrator is to increase concurrency to increase total performance without sacrificing performance for an individual user.

Row and key locks

Row and key locks generally provide the best overall performance when you are updating a relatively small number of rows, because they increase concurrency. However, the database server incurs some overhead in obtaining a lock. For an operation that changes a large number of rows, obtaining one lock per row might not be cost effective.

For an operation that changes a large number of rows, consider “Page locks” on page 8-2.

The default locking mode is page-locking. If you want row or key locks, you must create the table with row locking on or alter the table.

The following example shows how to create a table with row locking on:

```
CREATE TABLE customer(customer_num serial, lname char(20)...)
LOCK MODE ROW;
```

The ALTER TABLE statement can also change the lock mode.

When the lock mode is ROW and you insert or update a row, the database server creates a row lock. In some cases, you place a row lock by simply reading the row with a SELECT statement.

When the lock mode is ROW and you insert, update, or delete a key (performed automatically when you insert, update, or delete a row), the database server creates a lock on the key in the index.

Key-value locks

When a user deletes a row within a transaction, the row cannot be locked because it does not exist. However, the database server must somehow record that a row existed until the end of the transaction. The database server uses *key-value locking* to lock the deleted row.

When the database server deletes a row, key values in the indexes for the table are not removed immediately. Instead, each key value is marked as deleted, and a lock is placed on the key value.

Other users might encounter key values that are marked as deleted. The database server must determine whether a lock exists. If a lock exists, the delete has not been committed, and the database server sends a lock error back to the application (or it waits for the lock to be released if the user executed SET LOCK MODE TO WAIT).

One of the most important uses for key-value locking is to assure that a unique key remains unique through the end of the transaction that deleted it. Without this protection mechanism, user A might delete a unique key within a transaction, and user B might insert a row with the same key before the transaction commits. This scenario makes rollback by user A impossible. Key-value locking prevents user B from inserting the row until the end of user A's transaction.

Page locks

Page locking is the default mode when you create a table without the LOCK MODE clause. With page locking, instead of locking only the row, the database server locks the entire page that contains the row. If you update several rows on the same page, the database server uses only one lock for the page.

When you insert or update a row, the database server creates a page lock on the data page. In some cases, the database server creates a page lock when you simply read the row with a SELECT statement.

When you insert, update, or delete a key (performed automatically when you insert, update, or delete a row), the database server creates a lock on the page that contains the key in the index.

Important: A page lock on an index page can decrease concurrency more substantially than a page lock on a data page. Index pages are dense and hold a large number of keys. By locking an index page, you make a potentially large number of keys unavailable to other users until you release the lock. Tables that use page locks cannot support the USELASTCOMMITTED concurrency feature, which is described in the “Committed Read isolation” on page 8-6 section.

Page locks are useful for tables in which the normal user changes a large number of rows at one time. For example, an orders table that holds orders that are commonly inserted and queried individually is not a good candidate for page locking. But a table that holds old orders and is updated nightly with all of the orders placed during the day might be a good candidate. In this case, the type of isolation level that you use to access the table is important. For more information, see “Isolation level” on page 8-5.

Table locks

In a data warehouse environment, it might be more appropriate for queries to acquire locks of larger granularity. For example, if a query accesses most of the rows in a table, its efficiency increases if it acquires a smaller number of table locks instead of many page or row locks.

The database server can place two types of table locks:

- Shared lock
No other users can write to the table.
- Exclusive lock
No other users can read from or write to the table.

Another important distinction between these two types of table locks is the actual number of locks placed:

- In shared mode, the database server places one shared lock on the table, which informs other users that no updates can be performed. In addition, the database server adds locks for every row updated, deleted, or inserted.
- In exclusive mode, the database server places only one exclusive lock on the table, no matter how many rows it updates. If you update most of the rows in the table, place an exclusive lock on the table.

Important: A table lock on a table can decrease update concurrency radically. Only one update transaction can access that table at any given time, and that update transaction locks out all other transactions. However, multiple read-only transactions can simultaneously access the table. This behavior is useful in a data warehouse environment where the data is loaded and then queried by multiple users.

You can switch a table back and forth between table-level locking and the other levels of locking. This ability to switch locking levels is useful when you use a table in a data warehouse mode during certain time periods but not in others.

A transaction tells the database server to use table-level locking for a table with the LOCK TABLE statement. The following example places an exclusive lock on the table:

```
LOCK TABLE tab1 IN EXCLUSIVE MODE;
```

The following example places a shared lock on the table:

```
LOCK TABLE tab1 IN SHARE MODE;
```

In some cases, the database server places its own table locks. For example, if the isolation level is Repeatable Read, and the database server must read a large portion of the table, it places a table lock automatically instead of setting row or page locks. The database server places a table lock on a table when it creates or drops an index.

Database locks

You can place a lock on the entire database when you open the database with the DATABASE statement. A database lock prevents read or update access by anyone but the current user.

The following statement opens and locks the sales database:

```
DATABASE sales EXCLUSIVE
```

Configuring the lock mode

When you create a table, the default lock mode is page. You can change the lock mode (and thus increase or decrease concurrency) when you create or alter tables or by setting the **IFX_DEF_TABLE_LOCKMODE** environment variable or the **DEF_TABLE_LOCKMODE** configuration parameter.

If you know that most of your applications might benefit from a lock mode of row, you can take one of the following actions:

- Use the **LOCK MODE ROW** clause in each **CREATE TABLE** statement or **ALTER TABLE** statement.
- Set the **IFX_DEF_TABLE_LOCKMODE** environment variable to **ROW** so that all tables you subsequently create within a session use **ROW** without the need to specify the lock mode in the **CREATE TABLE** statement or **ALTER TABLE** statement.
- Set the **DEF_TABLE_LOCKMODE** configuration parameter to **ROW** so that all tables subsequently created within the database server use **ROW** without the need to specify the lock mode in the **CREATE TABLE** statement or **ALTER TABLE** statement.

If you change the lock mode with the **IFX_DEF_TABLE_LOCKMODE** environment variable or **DEF_TABLE_LOCKMODE** configuration parameter, the lock mode of existing tables are not affected. Existing tables continue to use the lock mode with which they were defined at the time they were created.

In addition, if you previously changed the lock mode of a table to **ROW**, and subsequently execute an **ALTER TABLE** statement to alter some other characteristic of the table (such as add a column or change the extent size), you do not need to specify the lock mode. The lock mode remains at **ROW** and is not set to the default **PAGE** mode.

You can still override the lock mode of individual tables by specifying the **LOCK MODE** clause in the **CREATE TABLE** statement or **ALTER TABLE** statement.

The following list shows the order of precedence for the lock mode on a table:

- The system default is page locks. The database server uses this system default if you do not set the configuration parameter, do not set the environment variable, or do not specify the **LOCK MODE** clause in the SQL statements.
- If you set the **DEF_TABLE_LOCKMODE** configuration parameter, the database server uses this value when you do not set the environment variable, or do not specify the **LOCK MODE** clause in the SQL statements.
- If you set the **IFX_DEF_TABLE_LOCKMODE** environment variable, this value overrides the **DEF_TABLE_LOCKMODE** configuration parameter and system default. The database server uses this value when you do not specify the **LOCK MODE** clause in the SQL statements.
- If you specify the **LOCK MODE** clause in the **CREATE TABLE** statement or **ALTER TABLE** statement, this value overrides the **IFX_DEF_TABLE_LOCKMODE**, the **DEF_TABLE_LOCKMODE** configuration parameter and system default.

Setting the lock mode to wait

When an application process encounters a lock, the default behavior of the database server is to return an error. Instead, you can run an SQL statement to set the lock mode to wait. This specifies that an application process does not proceed until the lock is removed.

To suspend the current process until the lock releases, run the following SQL statement :

```
SET LOCK MODE TO WAIT;
```

You can also specify the maximum number of seconds that a process waits for a lock to be released before issuing an error. In the following example, the database server waits for 20 seconds before issuing an error:

```
SET LOCK MODE TO WAIT 20;
```

To return to the default behavior (no waiting for locks), execute the following statement:

```
SET LOCK MODE TO NOT WAIT;
```

Locks with the SELECT statement

The type and duration of locks that the database server places depend on the isolation level set in the application, the database mode (logging, nonlogging, or ANSI,) and on whether the SELECT statement is within an update cursor. These locks can affect overall performance because they affect concurrency.

Isolation level

The number and duration of locks placed on data during a SELECT statement depend on the level of isolation that the user sets. The type of isolation can affect overall performance because it affects concurrency.

Before you execute a SELECT statement, you can set the isolation level with the SET ISOLATION statement, which is an Informix extension to the ANSI SQL-92 standard, or with the ANSI/ISO-compliant SET TRANSACTION. The main differences between the two statements are that SET ISOLATION has an additional isolation level, Cursor Stability, and SET TRANSACTION cannot be executed more than once in a transaction as SET ISOLATION can. The SET ISOLATION statement is an Informix extension to the ANSI SQL-92 standard. The SET ISOLATION statement can change the enduring isolation level for the session

Dirty Read isolation

The Dirty Read isolation (or ANSI Read Uncommitted) level does not place any locks on any rows fetched during a SELECT statement. Dirty Read isolation is appropriate for static tables that are used for queries.

Use Dirty Read isolation with care if update activity occurs at the same time. With Dirty Read, the reader can read a row that has not been committed to the database and might be eliminated or changed during a rollback. For example, consider the following scenario:

```
User 1 starts a transaction.  
User 1 inserts row A.  
User 2 reads row A.  
User 1 rolls back row A.
```

User 2 reads row A, which user 1 rolls back seconds later. In effect, user 2 read a row that was never committed to the database. Uncommitted data that is rolled back can be a problem in applications.

Because the database server does not check or place any locks for queries, Dirty Read isolation offers the best performance of all isolation levels. However, because of potential problems with uncommitted data that is rolled back, use Dirty Read isolation with care.

Because problems with uncommitted data that is rolled back are an issue only with transactions, databases that do not have transaction (and hence do not allow transactions) use Dirty Read as a default isolation level. In fact, Dirty Read is the only isolation level allowed for databases that do not have transaction logging.

Committed Read isolation

A reader with the Committed Read isolation (or ANSI Read Committed) isolation level checks for locks before returning a row. By checking for locks, the reader cannot return any uncommitted rows.

The database server does not actually place any locks for rows read during Committed Read. It simply checks for any existing rows in the internal lock table.

Committed Read is the default isolation level for databases with logging if the log mode is not ANSI-compliant. For databases created with a logging mode that is not ANSI-compliant, Committed Read is an appropriate isolation level for most activities. For ANSI-compliant databases, Repeatable Read is the default isolation level.

Ways to reduce the risk of Committed Read isolation level conflicts:

In the Committed Read isolation level, locks held by other sessions can cause SQL operations to fail if the current session cannot acquire a lock or if the database server detects a *deadlock*. (A deadlock occurs when two users hold locks, and each user wants to acquire a lock that the other user owns.) The LAST COMMITTED keyword option to the SET ISOLATION COMMITTED READ statement of SQL reduces the risk of locking conflicts.

The LAST COMMITTED keyword option to the SET ISOLATION COMMITTED READ statement of SQL instructs the server to return the most recently committed version of the rows, even if another concurrent session holds an exclusive lock. You can use the LAST COMMITTED keyword option for B-tree and functional indexes, tables that support transaction logging, and tables that do not have page-level locking or exclusive locks. For more information, see information about the SET ISOLATION statement in the *IBM Informix Guide to SQL: Syntax*.

For databases created with transaction logging, you can set the USELASTCOMMITTED configuration parameter to specify whether the database server uses the last committed version of the data, rather than wait for the lock to be released, when sessions using the Dirty Read or Committed Read isolation level (or the ANSI/ISO level of Read Uncommitted or Read Committed) attempt to read a row on which a concurrent session holds a shared lock. The last committed version of the data is the version of the data that existed before any updates occurred.

If no value or a value of NONE is set for the USELASTCOMMITTED configuration parameter or for the USELASTCOMMITTED session environment variable,

sessions in a COMMITTED READ or READ COMMITTED isolation level wait for any exclusive locks to be released, unless the SET ISOLATION COMMITTED READ LAST COMMITTED statement of SQL instructs the database server to read the most recently committed version of the data.

Setting the USELASTCOMMITTED configuration parameter to operate with the Committed Read isolation level can affect performance only if concurrent conflicting updates occur. When concurrent conflicting updates occur, the performance of queries depends on the dynamics of the transactions. For example, a reader using the last committed version of the data, might need to undo the updates made to a row by another concurrent transaction. This situation involves reading one or more log records, thereby increasing the I/O traffic, which can affect performance.

Related reference

 [USELASTCOMMITTED Configuration Parameter \(Administrator's Reference\)](#)

Cursor Stability isolation

A reader with Cursor Stability isolation acquires a shared lock on the row that is currently fetched. This action assures that no other user can update the row until the user fetches a new row.

In the example for a cursor in Figure 8-1, at *fetch a row* the database server releases the lock on the previous row and places a lock on the row being fetched. At *close the cursor*, the server releases the lock on the last row.

```
set isolation to cursor stability
declare cursor for SELECT * FROM customer
open the cursor
while there are more rows
    fetch a row
    do work
end while
close the cursor
```

Figure 8-1. Locks placed for cursor stability

If you do not use a cursor to fetch data, Cursor Stability isolation behaves in the same way as Committed Read. No locks are actually placed.

Repeatable Read isolation

Repeatable Read isolation (ANSI Serializable and ANSI Repeatable Read) is the strictest isolation level. With Repeatable Read, the database server locks all rows examined (not just fetched) for the duration of the transaction.

The example in Figure 8-2 on page 8-8 shows when the database server places and releases locks for a repeatable read. At *fetch a row*, the server places a lock on the row being fetched and on every row it examines in order to retrieve this row. At *close the cursor*, the server releases the lock on the last row.

```
set isolation to repeatable read
begin work
declare cursor for SELECT * FROM customer
open the cursor
while there are more rows
    fetch a row
    do work
end while
close the cursor
commit work
```

Figure 8-2. Locks placed for repeatable read

Repeatable Read is useful during any processing in which multiple rows are examined, but none must change during the transaction. For example, suppose an application must check the account balance of three accounts that belong to one person. The application gets the balance of the first account and then the second. But, at the same time, another application begins a transaction that debits the third account and credits the first account. By the time that the original application obtains the account balance of the third account, it has been debited. However, the original application did not record the debit of the first account.

When you use Committed Read or Cursor Stability, the previous scenario can occur. However, it cannot occur with Repeatable Read. The original application holds a read lock on each account that it examines until the end of the transaction, so the attempt by the second application to change the first account fails (or waits, depending upon SET LOCK MODE).

Because even examined rows are locked, if the database server reads the table sequentially, a large number of rows unrelated to the query result can be locked. For this reason, use Repeatable Read isolation for tables when the database server can use an index to access a table. If an index exists and the optimizer chooses a sequential scan instead, you can use directives to force use of the index. However, forcing a change in the query path might negatively affect query performance.

Locking nonlogging tables

The database server does not place page or row locks on a nonlogging table when you use the table within a transaction. However, you can lock nonlogging tables to prevent concurrency problems when other users are modifying a nonlogging table

Use one of the following methods to prevent concurrency problems when other users are modifying a nonlogging table:

- Lock the table in exclusive mode for the whole transaction.
- Use Repeatable Read isolation level for the whole transaction.

Important: Nonlogging raw tables are intended for fast loading of data. You should change the table to STANDARD before you use it in a transaction or modify the data within it.

Update cursors

An update cursor is a special kind of cursor that applications can use when the row might potentially be updated. Update cursors use *promotable locks* in which the database server places an update lock on the row when the application fetches the row. The lock is changed to an exclusive lock when the application uses an update cursor and UPDATE...WHERE CURRENT OF to update the row.

When the update lock is on the row as the application fetches it, other users can still view the row.

In some cases, the database server might place locks on rows that the database server has examined but not actually fetched. Whether this behavior occurs depends on how the database server executes the SQL statement.

The advantage of an update cursor is that you can view the row with the confidence that other users cannot change it or view it with an update cursor while you are viewing it and before you update it.

If you do not update the row, the default behavior of the database server is to release the update lock when you execute the next FETCH statement or close the cursor. However, if you execute the SET ISOLATION statement with the RETAIN UPDATE LOCKS clause, the database server does not release any currently existing or subsequently placed update locks until the end of the transaction.

The code in Figure 8-3 shows when the database server places and releases update locks with a cursor. At *fetch row 1*, the database server places an update lock on row 1. At *fetch row 2*, the server releases the update lock on row 1 and places an update lock on row 2. However, after the database server executes the SET ISOLATION statement with the RETAIN UPDATE LOCKS clause, it does not release any update locks until the end of the transaction. At *fetch row 3*, it places an update lock on row 3. At *fetch row 4*, it places an update lock on row 4. At *commit work*, the server releases the update locks for rows 2, 3, and 4.

```
declare update cursor
begin work
open the cursor
fetch row 1
fetch row 2
SET ISOLATION TO COMMITTED READ
    RETAIN UPDATE LOCKS
fetch row 3
fetch row 4
commit work
```

Figure 8-3. When update locks are released

In an ANSI-compliant database, update cursors are usually not needed because any select cursor behaves the same as an update cursor without the RETAIN UPDATE LOCKS clause.

The code in Figure 8-4 on page 8-10 shows the database server promoting an update lock to an exclusive lock. At *fetch the row*, the server places an update lock on the row being fetched. At *update the row*, the server promotes the lock to exclusive. At *commit work*, it releases the lock.

```

declare update cursor
begin work
open the cursor
fetch the row
do work
update the row (use WHERE CURRENT OF)
commit work

```

Figure 8-4. When update locks are promoted

To use an update cursor, run SELECT FOR UPDATE in your application.

Locks placed with INSERT, UPDATE, and DELETE statements

When you execute an INSERT, UPDATE, or DELETE statement, the database server uses exclusive locks. An exclusive lock means that no other users can view the row unless they are using the Dirty Read isolation level.

In addition, no other users can update or delete the item until the database server removes the lock.

When the database server removes the exclusive lock depends on the type of logging set for the database. If the database has logging, the database server removes all exclusive locks when the transaction completes (commits or rolls back). If the database does not have logging, the database server removes all exclusive locks immediately after the INSERT, UPDATE, or DELETE statement completes.

The internal lock table

The database server stores locks in an internal lock table. When the database server reads a row, it checks if the row or its associated page, table, or database is listed in the lock table. If it is in the lock table, the database server must also check the lock type.

The following table shows the types of locks that the lock table can contain.

Lock Type	Description	Statement That Usually Places the Lock
S	Shared lock	SELECT
X	Exclusive lock	INSERT, UPDATE, DELETE
U	Update lock	SELECT in an update cursor
B	Byte lock	Any statement that updates VARCHAR columns

A byte lock is generated only if you shrink the size of a data value in a VARCHAR column. The byte lock exists solely for roll forward and rollback execution, so a byte lock is created only if you are working in a database that uses logging. Byte locks appear in **onstat -k** output only if you are using row-level locking; otherwise, they are merged with the page lock.

In addition, the lock table might store *intent locks*, with the same lock type as previously shown. In some cases, a user might need to register his or her possible intent to lock an item, so that other users cannot place a lock on the item.

Depending on the type of operation and the isolation level, the database server might continue to read the row and place its own lock on the row, or it might wait

for the lock to be released (if the user executed SET LOCK MODE TO WAIT). The following table shows the locks that a user can place if another user holds a certain type of lock. For example, if one user holds an exclusive lock on an item, another user requesting any kind of lock (exclusive, update, or shared) receives an error.

	Hold X lock	Hold U lock	Hold S lock
Request X lock	No	No	Yes
Request U lock	No	No	Yes
Request S lock	No	Yes	Yes

Monitoring locks

You can analyze information about locks and monitor locks by viewing information in the internal lock table that contains stored locks.

View the lock table with **onstat -k**. Figure 8-5 shows sample output for **onstat -k**.

```

Locks
address  wtlist  owner   lklist  type    tblsnum rowid   key#/bsiz
300b77d0 0      40074140 0        HDR+S   10002   106    0
300b7828 0      40074140 300b77d0 HDR+S   10197   123    0
300b7854 0      40074140 300b7828 HDR+IX  101e4   0      0
300b78d8 0      40074140 300b7854 HDR+X   101e4   102    0
  4 active, 5000 total, 8192 hash buckets

```

Figure 8-5. **onstat -k** output

In this example, a user is inserting one row in a table. The user holds the following locks (described in the order shown):

- A shared lock on the database
- A shared lock on a row in the **sysstables** system catalog table
- An intent-exclusive lock on the table
- An exclusive lock on the row

To determine the table to which the lock applies, execute the following SQL statement. For *tblsnum*, substitute the value shown in the **tblsnum** field in the **onstat -k** output.

```

SELECT *
  FROM SYSTABLES
 WHERE HEX(PARTNUM) = "tblsnum";

```

Where *tblsnum* is the modified value that **onstat -k** returns. For example, if **onstat -k** returns 10027f, *tblsnum* is 0x0010027F.

You can also query the **syslocks** table in the **sysmaster** database to obtain information about each active lock. The **syslocks** table contains the following columns.

Column	Description
dbsname	Database on which the lock is held
tablename	Name of the table on which the lock is held
rowidlk	ID of the row on which the lock is held (0 indicates a table lock.)

Column	Description
keynum	The key number for the row
type	Type of lock
owner	Session ID of the lock owner
waiter	Session ID of the first waiter on the lock

Configuring and managing lock usage

The LOCKS configuration parameter specifies the initial size of the internal lock table. If the database server increases the size of the lock table, you should increase the size of the LOCKS configuration parameter.

For information about how to determine an initial value for the LOCKS configuration parameter, see “The LOCKS configuration parameter and memory utilization” on page 4-17.

If the number of locks needed by sessions exceeds the value set in the LOCKS configuration parameter, the database server attempts to increase the lock table by doubling its size. Each time that the lock table overflows (when the number of locks needed is greater than the current size of the lock table), the database server increases the size of the lock table, up to 99 times. Each time that the database server increases the size of the lock table, the server attempts to double its size. However, the server will limit each actual increase to no more than the maximum number of added locks shown in Table 8-1. After the 99th time that the database server increases the lock table, the server no longer increases the size of the lock table, and an application needing a lock receives an error.

Maximum number of locks allowed on 32-bit and 64-bit platforms

The following table shows the maximum number of allowed locks.

Table 8-1. Maximum number of locks on 32-bit and 64-bit platforms

Platform	Maximum Number of Initial Locks	Maximum Number of Dynamic Lock Table Extensions	Maximum Number of Locks Added Per Lock Table Extension	Maximum Number of Locks Allowed
32-bit	8,000,000	99	100,000	$8,000,000 + (99 \times 100,000)$
64-bit	500,000,000	99	1,000,000	$500,000,000 + (99 \times 1,000,000)$

View messages concerning increases to the size of the lock table

Every time the database server increases the size of the lock table, the server places a message in the message log file. You should monitor the message log file periodically and increase the size of the LOCKS configuration parameter if you see that the database server has increased the size of the lock table.

Monitor out-of-locks errors

To monitor the number of times that applications receive the out-of-locks error, view the **ovlock** field in the output of **onstat -p**. You can also see similar information from the **sysprofile** table in the **sysmaster** database. The following rows contain the relevant statistics.

Row	Description
ovlock	Number of times that sessions attempted to exceed the maximum number of locks
lockreqs	Number of times that sessions requested a lock
lockwts	Number of times that sessions waited for a lock

Examine how applications use locks

If the database server is using an unusually large number of locks, you can examine how individual applications are using locks, as follows:

1. Monitor sessions with **onstat -u** to see if a particular user is using an especially high number of locks (a high value in the **locks** column).
2. If a particular user uses a large number of locks, examine the SQL statements in the application to determine whether you should lock the table or use individual row or page locks.

A table lock is more efficient than individual row locks, but it reduces concurrency.

One way to reduce the number of locks placed on a table is to alter a table to use page locks instead of row locks. However, page locks reduce overall concurrency for the table, which can affect performance.

You can also reduce the number of locks placed on a table by locking the table in exclusive mode.

Related concepts

“The LOCKS configuration parameter and memory utilization” on page 4-17

Monitoring lock waits and lock errors

You can view information about sessions, lock usage, and lock waits.

If the application executes **SET LOCK MODE TO WAIT**, the database server waits for a lock to be released instead of returning an error. An unusually long wait for a lock can give users the impression that the application is hanging.

In Figure 8-6 on page 8-14, the **onstat -u** output shows that session ID 84 is waiting for a lock (L in the first column of the **Flags** field). To find out the owner of the lock, use the **onstat -k** command.

```

onstat -u

Userthreads
address flags  sessid user   tty   wait   tout locks nreads nwrites
40072010 ---P--D 7     informix -    0     0     0     35     75
400723c0 ---P--- 0     informix -    0     0     0     0     0
40072770 ---P--- 1     informix -    0     0     0     0     0
40072b20 ---P--- 2     informix -    0     0     0     0     0
40072ed0 ---P--F 0     informix -    0     0     0     0     0
40073280 ---P--B 8     informix -    0     0     0     0     0
40073630 ---P--- 9     informix -    0     0     0     0     0
400739e0 ---P--D 0     informix -    0     0     0     0     0
40073d90 ---P--- 0     informix -    0     0     0     0     0
40074140 Y-BP--- 81     lsuto   4   50205788 0     4     106    221
400744f0 --BP--- 83     jsmit   -    0     0     4     0     0
400753b0 ---P--- 86     worth   -    0     0     2     0     0
40075760 L--PR-- 84     jones   3   300b78d8 -1    2     0     0
13 active, 128 total, 16 maximum concurrent

onstat -k

Locks
address wtlist  owner   lklist  type  tblsum rowid  key#/bsiz
300b77d0 0         40074140 0      HDR+S 10002 106    0
300b7828 0         40074140 300b77d0 HDR+S 10197 122    0
300b7854 0         40074140 300b7828 HDR+IX 101e4 0      0
300b78d8 40075760 40074140 300b7854 HDR+X 101e4 100    0
300b7904 0         40075760 0      S      10002 106    0
300b7930 0         40075760 300b7904 S      10197 122    0
6 active, 5000 total, 8192 hash buckets

```

Figure 8-6. onstat -u output that shows lock usage

To find out the owner of the lock for which session ID 84 is waiting:

1. Obtain the address of the lock in the **wait** field (300b78d8) of the **onstat -u** output.
2. Find this address (300b78d8) in the **Locks address** field of the **onstat -k** output. The **owner** field of this row in the **onstat -k** output contains the address of the user thread (40074140).
3. Find this address (40074140) in the **Userthreads** field of the **onstat -u** output. The **sessid** field of this row in the **onstat -u** output contains the session ID (81) that owns the lock.

To eliminate the contention problem, you can have the user exit the application gracefully. If this solution is not possible, you can stop the application process or remove the session with **onmode -z**.

Monitoring the number of free locks

You can find the current number of free locks on a lock-free list by viewing the output of the **onstat -L** command .

Related reference

 **onstat -L** command: Print the number of free locks (Administrator's Reference)

Monitoring deadlocks

You can monitor deadlocks. A *deadlock* occurs when two users hold locks, and each user wants to acquire a lock that the other user owns.

For example, user **pradeep** holds a lock on row 10. User **jane** holds a lock on row 20. Suppose that **jane** wants to place a lock on row 10, and **pradeep** wants to place a lock on row 20. If both users execute `SET LOCK MODE TO WAIT`, they potentially might wait for each other forever.

Informix uses the lock table to detect deadlocks automatically and stop them before they occur. Before a lock is granted, the database server examines the lock list for each user. If a user holds a lock on the resource that the requestor wants to lock, the database server traverses the lock wait list for the user to see if the user is waiting for any locks that the requestor holds. If so, the requestor receives a deadlock error.

Deadlock errors can be unavoidable when applications update the same rows frequently. However, certain applications might always be in contention with each other. Examine applications that are producing a large number of deadlocks and try to run them at different times.

To monitor the number of deadlocks, use the **deadlks** field in the output of `onstat -p`.

In a distributed transaction, the database server does not examine lock tables from other database server systems, so deadlocks cannot be detected before they occur. Instead, you can set the `DEADLOCK_TIMEOUT` configuration parameter. `DEADLOCK_TIMEOUT` specifies the number of seconds that the database server waits for a remote database server response before it returns an error. Although reasons other than a distributed deadlock might cause the delay, this mechanism keeps a transaction from hanging indefinitely.

To monitor the number of distributed deadlock timeouts, use the **dltouts** field in the `onstat -p` output.

Monitoring isolation levels that sessions use

The `onstat -g ses` and `onstat -g sql` output shows the isolation level that a session is currently using.

The following table summarizes the values in the **IsoLvl** column in `onstat -g ses` and `onstat -g sql` output.

Value	Description
DR	Dirty Read
CR	Committed Read
CS	Cursor Stability
CRU	Committed Read with RETAIN UPDATE LOCKS
CSU	Cursor Stability with RETAIN UPDATE LOCKS
DRU	Dirty Read with RETAIN UPDATE LOCKS
LC	Committed Read, Last Committed
RR	Repeatable Read

If a great deal of lock contention occurs, check the isolation level of sessions to make sure it is appropriate for the application.

Locks for smart large objects

Smart large objects have several unique locking behaviors because their columns are typically much larger than other columns in a table.

This section discusses the following unique behaviors:

- Types of locks on smart large objects
- Byte-range locking
- Lock promotion
- Dirty Read isolation level with smart large objects

Types of locks on smart large objects

The database server uses one of the following granularity levels for locking smart large objects:

- The sbspace chunk header partition
- The smart large object
- A byte range of the smart large object

The default locking granularity is at the level of the smart large object. In other words, when you update a smart large object, by default the database server locks the smart large object that is being updated.

Locks on the sbspace chunk header partition only occur when the database server promotes locks on smart large objects. For more information, see “Lock promotion” on page 8-19.

Byte-range locking

Rather than locking the entire smart large object, you can lock only a specific byte range of a smart large object.

Byte-range locking is advantageous because it allows multiple users to update the same smart large object simultaneously, as long as they are updating different parts of it. Also, users can read a part of a smart large object while another user is updating or reading a different part of the same smart large object.

Figure 8-7 shows two locks placed on a single smart large object. The first lock is on bytes 2, 3, and 4. The second lock is on byte 6 alone.

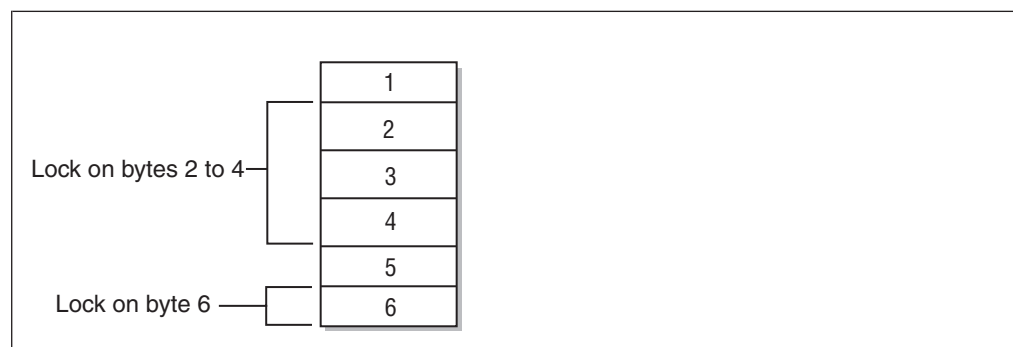

Figure 8-7. Example of byte-range locking

How the database server manages byte-range locks

The database server manages byte-range locks in the lock table in a similar fashion to other locks placed on rows, pages, and tables. However, the lock table must also store the byte range.

If you place a second lock on a byte range adjacent to a byte range that is currently locked, the database server consolidates the two locks into one lock on the entire range.

If a user holds locks that the Figure 8-7 on page 8-16 shows, and the user requests a lock on byte five, the database server consolidates the locks placed on bytes two through six into one lock.

Likewise, if a user unlocks only a portion of the bytes included within a byte-range lock, the database server might be split into multiple byte-range locks. In the Figure 8-7 on page 8-16 the user could unlock byte three, which causes the database server to change the one lock on bytes two through four to one lock on byte two and one lock on byte four.

Using byte-range locks

By default, the database server places a lock on the smart large object. Instead, you can enable byte-range locking.

To use byte-range locks, you must perform one of the following actions:

- To set byte-range locking for the sbspace that stores the smart large object, use the **onspaces** utility. The following example sets byte-range locking for the new sbspace:

```
onspaces -c -S slo -g 2 -p /ix/9.2/liz/slo -o 0 -s 1000
-Df LOCK_MODE=RANGE
```

When you set the default locking mode for the sbspace to byte-range locking, the database server locks only the necessary bytes when it updates any smart large objects stored in the sbspace.

- To set byte-range locking for the smart large object when you open it, use one of the following methods:
 - *In DB-Access:* Set the MI_LO_LOCKRANGE flag in the **mi_lo_open()** DataBlade API function.
 - *In ESQ/C:* Set the LO_LOCKRANGE flag in the **ifx_lo_open()** Informix ESQ/C function. When you set byte-range locking for the individual smart large object, the database server implicitly locks only the necessary bytes when it selects or updates the smart large object.
- To lock a byte range explicitly, use one of the following functions:
 - *For DB-Access:* **mi_lo_lock()**
 - *For ESQ/C:* **ifx_lo_lock()**

These functions lock the range of bytes that you specify for the smart large object. If you specify an exclusive lock with either function, UPDATE statements do not place locks on the smart large object if they update the locked bytes.

The database server releases exclusive byte-range locks placed with **mi_lo_lock()** or **ifx_lo_lock()** at the end of the transaction. The database server releases shared byte-range locks placed with **mi_lo_lock()** or **ifx_lo_lock()** based on the same rules as locks placed with SELECT statements, depending upon the isolation level. You can also release shared byte-range locks with one of the following functions:

- For DB-Access:mi_lo_unlock(). For more information about the DataBlade API functions, see the *IBM Informix DataBlade API Programmer's Guide*.
- For ESQL/C:ifx_lo_unlock(). For more information about Informix ESQL/C functions, see the *IBM Informix ESQL/C Programmer's Manual*.

Monitoring byte-range locks

You can use **onstat -k** to list all byte-range locks. Use the **onstat -K** command to list byte-range locks and all waiters for byte-range locks.

Figure 8-8 shows an excerpt from the output of **onstat -k**.

Byte-Range Locks								
rowid/LOid	tblsnum	address	status	owner	offset	size	type	
104	200004	a020e90	HDR					
[2, 2, 3]		a020ee4	HOLD	a1b46d0	50	10	S	
202	200004	a021034	HDR					
[2, 2, 5]		a021088	HOLD	a1b51e0	40	5	S	
102	200004	a035608	HDR					
[2, 2, 1]		a0358fc	HOLD	a1b4148	0	500	S	
		a035758	HOLD	a1b3638	300	100	S	
21 active, 2000 total, 2048 hash buckets								

Figure 8-8. Byte-range locks in onstat -k output

Byte-range locks produce the following information in the **onstat -k** output.

Column	Description
rowid	The rowid of the row that contains the locked smart large object
LOid	The three values: sbspace number, chunk number, and sequence number (a value that represents the position in the chunk)
tblsnum	The number of the tblspace that holds the smart large object
address	The address of the lock
status	The status of the lock HDR is a placeholder. HOLD indicates the user specified in the owner column owns the lock. WAIT (shown only with onstat -K) indicates that the user specified in the owner column is waiting for the lock.
owner	The address of the owner (or waiter) Cross reference this value with the address in onstat -u .
offset	The offset into the smart large object where the bytes are locked
size	The number of bytes locked, starting at the value in the offset column
type	S (shared lock) or X (exclusive)

Setting number of locks for byte-range locking

When you use byte-range locking, the database server can use more locks because of the possibility of multiple locks on one smart large object. Even though the lock

table grows when it runs out of space, you might want to increase value of the LOCKS configuration parameter to match lock usage so that the database server does not need to allocate more space dynamically.

Be sure to monitor the number of locks used with **onstat -k**, so you can determine if you need to increase the value of the LOCKS configuration parameter.

Lock promotion

The database server uses lock promotion to decrease the total number of locks held on smart large objects. Too many locks can result in poorer performance because the database server frequently searches the lock table to determine if a lock exists on an object.

If the number of locks held by a transaction exceeds 33 percent of the current number of allocated locks for the database server, the database server attempts to promote any existing byte-range locks to a single lock on the smart large object.

If the number of locks that a user holds on a smart large object (not on byte ranges of a smart large object) equals or exceeds 10 percent of the current capacity of the lock table, the database server attempts to promote all of the smart-large-object locks to one lock on the smart-large-object header partition. This kind of lock promotion improves performance for applications that are updating, loading, or deleting a large number of smart large objects. For example, a transaction that deletes millions of smart large objects would consume the entire lock table if the database server did not use lock promotion. The lock promotion algorithm has deadlock avoidance built in.

You can identify a smart-large-object header partition in **onstat -k** by 0 in the **rowid** column and a tablespace number with a high-order first byte-and-a-half that corresponds to the dbspace number where the smart large object is stored. For example, if the tblspace number is listed as 0x200004 (the high-order zeros are truncated), the dbspace number 2 corresponds to the dbspace number listed in **onstat -d**.

Even if the database server attempts to promote a lock, it might not be able to do so. For example, the database server might not be able to promote byte-range locks to one smart-large-object lock because other users have byte-range locks on the same smart large object. If the database server cannot promote a byte-range lock, it does not change the lock, and processing continues as normal.

Dirty Read isolation level and smart large objects

You can use the Dirty Read isolation level for smart large objects.

For information about how Dirty Reads affects consistency, see “Dirty Read isolation” on page 8-5.

Set the Dirty Read isolation level for smart large objects in one of the following ways:

- Use the SET TRANSACTION MODE or SET ISOLATION statement.
- Use the LO_DIRTY_READ flag in one of the following functions:
 - For *DB-Access:mi_lo_open()*
 - For *ESQL/C:ifx_lo_open()*

If consistency for smart large objects is not important, but consistency for other columns in the row is important, you can set the isolation level to Committed Read, Cursor Stability, or Repeatable Read and open the smart large object with the LO_DIRTY_READ flag.

Chapter 9. Fragmentation guidelines

One of the most frequent causes of poor performance in relational database systems is contention for data that resides on a single I/O device. Proper fragmentation of high-use tables can significantly reduce I/O contention. These topics discuss the performance considerations that are involved when you use table fragmentation.

The database server supports table fragmentation (also *partitioning*), which allows you to store data from a single table on multiple disk devices. Fragmentation enables you to define groups of rows or index keys within a table according to some algorithm or scheme. You can store each group or fragment (also referred to as a *partition*) in a separate dbspace associated with a specific physical disk.

For information about fragmentation and parallel execution, see Chapter 12, “Parallel database query (PDQ),” on page 12-1.

For an introduction to fragmentation concepts and methods, see the *IBM Informix Database Design and Implementation Guide*. For information about the SQL statements that manage fragments, see the *IBM Informix Guide to SQL: Syntax*.

Planning a fragmentation strategy

You can decide on a fragmentation goal for your database and devise a strategy to meet that goal.

A fragmentation strategy consists of two parts:

- A distribution scheme that specifies how to group rows into fragments
You specify the distribution scheme in the FRAGMENT BY clause of the CREATE TABLE, CREATE INDEX, or ALTER FRAGMENT statements.
- The set of dbspaces in which you locate the fragments
You specify the set of dbspaces or in the IN clause (storage option) of these SQL statements.

To formulate a fragmentation strategy:

1. Decide on your primary fragmentation goal, which should depend, to a large extent, on the types of applications that access the table.
2. Make the following decisions based on your primary fragmentation goal:
 - Whether to fragment the table data, the table index, or both
 - What the ideal distribution of rows or index keys is for the table
3. Choose either an expression-based or round-robin distribution scheme:
 - If you choose an expression-based distribution scheme, you must then design suitable fragment expressions.
 - If you choose a round-robin distribution scheme, the database server determines which rows to put into a specific fragment.

For more information, see “Distribution schemes” on page 9-6.

4. To complete the fragmentation strategy, you must decide on the number and location of the fragments:
 - The number of fragments depends on your primary fragmentation goal.

- Where you locate fragments depends on the number of disks available in your configuration.

When you plan a fragmentation strategy, be aware of these space and page issues:

- Although a 4-terabyte chunk can be on a 2-kilobyte page, only 32 gigabytes can be utilized in a dbspace because of a rowid format limitation.
- For a fragmented table, all fragments must use the same page size.
- For a fragmented index, all fragments must use the same page size.
- A table can be in one dbspace and the index for that table can be in another dbspace. These dbspaces do not need to have the same page size.

Fragmentation goals

You can analyze your application and workload to identify fragmentation goals and to determine the balance to strike among fragmentation goals.

Fragmentation goals can include:

- Improved performance for individual queries
To improve the performance of individual queries, fragment tables appropriately and set resource-related parameters to specify system resource use (memory, CPU virtual processors, and so forth).
- Reduced contention between queries and transactions
- If your database server is used primarily for online transaction processing (OLTP) and only incidentally for decision-support queries, you can often use fragmentation to reduce contention when simultaneous queries against a table perform index scans to return a few rows.
- Increased data availability
Careful fragmentation of dbspaces can improve data availability if devices fail. Table fragments on the failed device can be restored quickly, and other fragments are still accessible.
- Improved data-load performance
When you use the High-Performance Loader (HPL) to load a table that is fragmented across multiple disks, it allocates threads to light append the data into the fragments in parallel. For more information about this load method, see the *IBM Informix High-Performance Loader User's Guide*.
You can also use the alter fragment ON table statement with the attach clause to add data quickly to a very large table. For more information, see "Improve the performance of operations that attach and detach fragments" on page 9-18.

The performance of a fragmented table is primarily governed by the following factors:

- The storage option that you use for allocating disk space to fragments (discussed in "Considering physical fragmentation factors" on page 9-5)
- The distribution scheme used to assign rows to individual fragments (discussed in "Distribution schemes" on page 9-6)

Improved query performance through fragmentation strategy

If the primary goal of fragmentation is improved performance for individual queries, try to distribute all of the rows of the table evenly over the different disks. Overall query-completion time is reduced when the database server does not need to wait for data retrieval from a table fragment that has more rows than other fragments.

If queries access data by performing sequential scans against significant portions of tables, fragment the table rows only. Do not fragment the index. If an index is fragmented and a query has to cross a fragment boundary to access the data, the performance of the query can be worse than if you do not fragment.

If queries access data by performing an index read, you can improve performance by using the same distribution scheme for the index and the table.

If you use round-robin fragmentation, do not fragment your index. Consider placing that index in a separate dbspace from other table fragments.

For more information about improving performance for queries, see “Query expressions for fragment elimination” on page 9-14 and Chapter 13, “Improving individual query performance,” on page 13-1.

Reduced contention between queries and transactions

Fragmentation can reduce contention for data in tables that multiple queries and OLTP applications use. Fragmentation often reduces contention when many simultaneous queries against a table perform index scans to return a few rows.

For tables subjected to this type of load, fragment both the index keys and data rows with a distribution scheme that allows each query to eliminate unneeded fragments from its scan. Use an expression-based distribution scheme. For more information, see “Distribution schemes that eliminate fragments” on page 9-13.

To fragment a table for reduced contention, start by investigating which queries access which parts of the table. Next, fragment your data so that some of the queries are routed to one fragment while others access a different fragment. The database server performs this routing when it evaluates the fragmentation rule for the table. Finally, store the fragments on separate disks.

Your success in reducing contention depends on how much you know about the distribution of data in the table and the scheduling of queries against the table. For example, if the distribution of queries against the table is set up so that all rows are accessed at roughly the same rate, try to distribute rows evenly across the fragments. However, if certain values are accessed at a higher rate than others, you can compensate for this difference by distributing the rows over the fragments to balance the access rate. For more information, see “Designing an expression-based distribution scheme” on page 9-7.

Increased data availability

When you distribute table and index fragments across different disks or devices, you improve the availability of data during disk or device failures. The database server continues to allow access to fragments stored on disks or devices that remain operational.

This availability has important implications for the following types of applications:

- Applications that do not require access to unavailable fragments

A query that does not require the database server to access data in an unavailable fragment can still successfully retrieve data from fragments that are available. For example, if the distribution expression uses a single column, the database server can determine if a row is contained in a fragment without accessing the fragment. If the query accesses only rows that are contained in available fragments, a query can succeed even when some of the data in the table is unavailable. For more information, see “Designing an expression-based distribution scheme” on page 9-7.

- Applications that accept the unavailability of data
Some applications might be designed in such a way that they can accept the unavailability of data in a fragment and require the ability to retrieve the data that is available. To specify which fragments can be skipped, these applications can execute the SET DATASKIP statement before they execute a query. Alternatively, the database server administrator can use the onspaces -f option to specify which fragments are unavailable.

If your fragmentation goal is increased availability of data, fragment both table rows and index keys so that if a disk drive fails, some of the data is still available. If applications must always be able to access a subset of your data, keep those rows together in the same mirrored dbspace.

Increased granularity for backup and restore

You must consider backup and restore factors when you are deciding how to distribute dbspaces across disk.

Backup and restore factors to consider are:

- **Data availability.** When you decide where to place your tables or fragments, remember that if a device that contains a dbspace fails, all tables or table fragments in that dbspace are inaccessible, even though tables and fragments in other dbspaces are accessible. The need to limit data unavailability in the event of a disk failure might influence which tables you group together in a particular dbspace.
- **Cold versus warm restores.** Although you must perform a cold restore if a dbspace that contains critical data fails, you need to perform only a warm restore if a noncritical dbspace fails. The desire to minimize the impact of cold restores might influence the dbspace that you use to store critical data.

For more information about backup and restore, see your *IBM Informix Backup and Restore Guide*.

Examining your data and queries

To determine a fragmentation strategy, you must gather information about the table that you might fragment. You must also know how the data in the table is used.

To gather information about your table:

1. Identify the queries that are critical to performance to determine if the queries are online transaction processing (OLTP) or decision-support system (DSS) queries.
2. Use the SET EXPLAIN statement to determine how the data is being accessed.
For information about the output of the SET EXPLAIN statement, see “Report that shows the query plan chosen by the optimizer” on page 10-9. To determine how the data is accessed, you can sometimes simply review the SELECT statements along with the table schema.
3. Determine what portion of the data each query examines.
For example, if certain rows in the table are read most of the time, you can isolate them in a small fragment to reduce I/O contention for other fragments.
4. Determine which statements create temporary files.
Decision-support queries typically create and access large temporary files, and placement of temporary dbspaces can be critical to performance.

5. If particular tables are always joined together in a decision-support query, spread fragments for these tables across different disks.
6. Examine the columns in the table to determine which fragmentation scheme would keep each scan thread equally busy for the decision-support queries. To see how the column values are distributed, create a distribution on the column with the UPDATE STATISTICS statement and examine the distribution with **dbschema**.

```
dbschema -d database -hd table
```

Considering physical fragmentation factors

When you fragment a table, the physical placement issues that pertain to tables apply to individual table fragments. Because each fragment resides in its own dbspace on a disk, you must address these issues separately for the fragments on each disk.

For details about placement issues that apply to tables, see Chapter 6, “Table performance considerations,” on page 6-1.

Fragmented and nonfragmented tables differ in the following ways:

- For fragmented tables, each fragment is placed in a separate, designated dbspace or multiple named fragments of the table are created within a single dbspace. For nonfragmented tables, the table can be placed in the default dbspace of the current database. Regardless of whether the table is fragmented or not, you should create a single chunk on each disk for each dbspace.
- Extent sizes for a fragmented table are usually smaller than the extent sizes for an equivalent nonfragmented table because fragments do not grow in increments as large as the entire table. For more information on how to estimate the space to allocate, see “Estimating table size” on page 6-5.
- In a fragmented table, the row pointer is not a unique unchanging pointer to the row on a disk. The database server uses the combination of fragment ID and row pointer internally, inside an index, to point to the row. These two fields are unique but can change over the life of the row. An application cannot access the fragment ID; therefore, you should use primary keys to access a specific row in a fragmented table. For more information, see the *IBM Informix Database Design and Implementation Guide*.
- An attached index or an index on a nonfragmented table uses 4 bytes for the row pointer. A detached index uses 8 bytes of disk space per key value for the fragment ID and row pointer combination. For more information about how to estimate space for an index, see “Estimating index pages” on page 7-3. For more information on attached indexes and detached indexes, see “Strategy for fragmenting indexes” on page 9-9.

Decision-support queries usually create and access large temporary files; placement of temporary dbspaces is a critical factor for performance. For more information about placement of temporary files, see “Spreading temporary tables and sort files across multiple disks” on page 6-4.

Distribution schemes

After you decide whether to fragment table rows, index keys, or both, and you decide how the rows and keys should be distributed over fragments, you can decide on a scheme to implement this distribution. Informix supports random distribution among fragments and value-based distribution among fragments.

Random distribution among fragments:

- **Round-robin fragmentation.** This type of fragmentation places rows one after another in fragments, rotating through the series of fragments to distribute the rows evenly.

For smart large objects, you can specify multiple sbspaces in the PUT clause of the CREATE TABLE or ALTER TABLE statement to distribute smart large objects in a round-robin distribution scheme so that the number of smart large objects in each space is approximately equal.

For INSERT statements, the database server uses a hash function on a random number to determine the fragment in which to place the row. For INSERT cursors, the database server places the first row in a random fragment, the second in the next fragment sequentially, and so on. If one of the fragments is full, it is skipped.

Value-based distribution among fragments:

- **Expression-based fragmentation.** This type of fragmentation puts rows that contain specified values in the same fragment. You specify a *fragmentation expression* that defines criteria for assigning a set of rows to each fragment, either as a range rule or some arbitrary rule.

You can specify a *remainder fragment* that holds all rows that do not match the criteria for any other fragment, although a remainder fragment reduces the efficiency of the expression-based distribution scheme.

Related reference

 [Fragmenting by LIST \(SQL Syntax\)](#)

Choosing a distribution scheme

When choosing a distribution scheme, you must consider the ease of data balancing, whether you want fragments to be eliminated, and the effect of the data skip feature.

Table 9-1 compares round-robin and expression-based distribution schemes.

Table 9-1. Distribution-Scheme Comparisons

Distribution Scheme	Ease of Data Balancing	Fragment Elimination	Data Skip
Round-robin	Automatic. Data is balanced over time.	The database server cannot eliminate fragments.	You cannot determine if the integrity of the transaction is compromised when you use the data-skip feature. However, you can insert into a table fragmented by round-robin.
Expression-based	Requires knowledge of the data distribution.	If expressions on one or two columns are used, the database server can eliminate fragments for queries that have either range or equality expressions.	You can determine whether the integrity of a transaction has been compromised when you use the data-skip feature. You cannot insert rows if the appropriate fragment for those rows is down.

The distribution scheme that you choose depends on the following factors:

- The features in Table 9-1 on page 9-6 of which you want to take advantage
- Whether or not your queries tend to scan the entire table
- Whether or not you know the distribution of data to be added
- Whether or not your applications tend to delete many rows
- Whether or not you cycle your data through the table

Basically, the round-robin scheme provides the easiest and surest way of balancing data. However, with round-robin distribution, you have no information about the fragment in which a row is located, and the database server cannot eliminate fragments.

In general, round-robin is the correct choice only when all the following conditions apply:

- Your queries tend to scan the entire table.
- You do not know the distribution of data to be added.
- Your applications tend not to delete many rows. (If they do, load balancing can be degraded.)

An expression-based scheme might be the best choice to fragment the data if any of the following conditions apply:

- Your application calls for numerous decision-support queries that scan specific portions of the table.
- You know what the data distribution is.
- You plan to cycle data through a database.

If you plan to add and delete large amounts of data periodically, based on the value of a column such as date, you can use that column in the distribution scheme. You can then use the `alter fragment attach` and `alter fragment detach` statements to cycle the data through the table.

The `ALTER FRAGMENT ATTACH` and `DETACH` statements provide the following advantages over bulk loads and deletes:

- The rest of the table fragments are available for other users to access. Only the fragment that you attach or detach is not available to other users.
- With the performance enhancements, the execution of an `ALTER FRAGMENT ATTACH` or `DETACH` statement is much faster than a bulk load or mass delete.

For more information, see “Improve the performance of operations that attach and detach fragments” on page 9-18.

In some cases, an appropriate index scheme can circumvent the performance problems of a particular distribution scheme. For more information, see “Strategy for fragmenting indexes” on page 9-9.

Designing an expression-based distribution scheme

The first step in designing an expression-based distribution scheme is to determine the distribution of data in the table, particularly the distribution of values for the column on which you base the fragmentation expression.

To obtain this information, run the `UPDATE STATISTICS` statement for the table and then use the `dbschema` utility to examine the distribution.

After you know the data distribution, you can design a fragmentation rule that distributes data across fragments as required to meet your fragmentation goal. If your primary goal is to improve performance, your fragment expression should generate an even distribution of rows across fragments.

If your primary fragmentation goal is improved concurrency, analyze the queries that access the table. If certain rows are accessed at a higher rate than others, you can compensate by opting for an uneven distribution of data over the fragments that you create.

Try not to use columns that are subject to frequent updates in the distribution expression. Such updates can cause rows to move from one fragment to another (that is, be deleted from one and added to another), and this activity increases CPU and I/O overhead.

Try to create nonoverlapping regions based on a single column with no REMAINDER fragment for the best fragment-elimination characteristics. The database server eliminates fragments from query plans whenever the query optimizer can determine that the values selected by the WHERE clause do not reside on those fragments, based on the expression-based fragmentation rule by which you assign rows to fragments. For more information, see “Distribution schemes that eliminate fragments” on page 9-13.

Suggestions for improving fragmentation

You can improve fragmentation for optimal performance in decision-support and OLTP queries.

The following suggestions are guidelines for fragmenting tables and indexes:

- For optimal performance in decision-support queries, fragment the table to increase parallelism, but do not fragment the indexes. Detach the indexes, and place them in a separate dbspace.
- For best performance in OLTP queries, use fragmented indexes to reduce contention between sessions. You can often fragment an index by its key value, which means the OLTP query only has to look at one fragment to find the location of the row.

If the key value does not reduce contention, as when every user looks at the same set of key values (for instance, a date range), consider fragmenting the index on another value used in the WHERE clause. To cut down on fragment administration, consider not fragmenting some indexes, especially if you cannot find a good fragmentation expression to reduce contention.

- Use round-robin fragmentation on data when the table is read sequentially by decision-support queries. Round-robin fragmentation is a good method for spreading data evenly across disks when no column in the table can be used for an expression-based fragmentation scheme. However, in most DSS queries, all fragments are read.
- To reduce the total number of required dbspaces and decrease the time needed for searches, you can store multiple named fragments within the same dbspace.
- If you are using expressions, create them so that I/O requests, rather than quantities of data, are balanced across disks. For example, if the majority of your queries access only a portion of data in the table, set up your fragmentation expression to spread active portions of the table across disks, even if this arrangement results in an uneven distribution of rows.

- Keep fragmentation expressions simple. Fragmentation expressions can be as complex as you want. However, complex expressions take more time to evaluate and might prevent fragments from being eliminated from queries.
- Arrange fragmentation expressions so that the most restrictive condition for each dbspace is tested within the expression first. When the database server tests a value against the criteria for a given fragment, evaluation stops when a condition for that fragment tests false. Thus, if the condition that is most likely to be false is placed first, fewer conditions need to be evaluated before the database server moves to the next fragment. For example, in the following expression, the database server tests all six of the inequality conditions when it attempts to insert a row with a value of 25:

```
x >= 1 and x <= 10 in dbspace1,
x > 10 and x <= 20 in dbspace2,
x > 20 and x <= 30 in dbspace3
```

By comparison, only four conditions in the following expression need to be tested: the first inequality for **dbspace1** ($x \leq 10$), the first for **dbspace2** ($x \leq 20$), and both conditions for **dbspace3**:

```
x <= 10 and x >= 1 in dbspace1,
x <= 20 and x > 10 in dbspace2,
x <= 30 and x > 20 in dbspace3
```

- Avoid any expression that requires a data-type conversion. Type conversions increase the time to evaluate the expression. For instance, a DATE data type is implicitly converted to INTEGER for comparison purposes.
- Do not fragment on columns that change frequently unless you are willing to incur the administration costs. For example, if you fragment on a date column and older rows are deleted, the fragment with the oldest dates tends to empty, and the fragment with the recent dates tends to fill up. Eventually you must drop the old fragment and add a new fragment for newer orders.
- Do not fragment every table. Identify the critical tables that are accessed most frequently. Put only one fragment for a table on a disk.
- Do not fragment small tables. Fragmenting a small table across many disks might not be worth the overhead of starting all the scan threads to access the fragments. Also, balance the number of fragments with the number of processors on your system.
- When you define a fragmentation strategy on an unfragmented table, check the next-extent size to ensure that you are not allocating large amounts of disk space for each fragment.

Strategy for fragmenting indexes

When you fragment a table, the indexes that are associated with that table are fragmented implicitly, according to the fragmentation scheme that you use. You can also use the FRAGMENT BY clause of the CREATE INDEX statement to fragment the index on any table explicitly.

Each index of a fragmented table occupies its own tblspace with its own extents.

You can fragment the index with either of the following strategies:

- Same fragmentation strategy as the table
- Different fragmentation strategy from the table

Attached indexes

An *attached index* is an index that implicitly follows the table fragmentation strategy (distribution scheme and set of dbspaces in which the fragments are located). The database server automatically creates an attached index when you first fragment a table.

To create an attached index, do not specify a fragmentation strategy or storage option in the CREATE INDEX statement, as in the following sample SQL statements:

```
CREATE TABLE tb1(a int)
  FRAGMENT BY EXPRESSION
    (a >=0 AND a < 5) IN dbsbpace1,
    (a >=5 AND a < 10) IN dbspace2
    ...
;

CREATE INDEX idx1 ON tb1(a);
```

For fragmented tables that use expression-based or round-robin distribution schemes, you can also create multiple partitions of a table or index within a single dbspace. This enables you to reduce the number of required dbspaces, thereby simplifying the management of dbspaces.

To create an attached index with partitions, include the partition name in your SQL statements, as shown in this example:

```
CREATE TABLE tb1(a int)
  FRAGMENT BY EXPRESSION
    PARTITION part1 (a >=0 AND a < 5) IN dbs1,
    PARTITION part2 (a >=5 AND a < 10) IN dbs1
    ...
;

CREATE INDEX idx1 ON tb1(a);
```

You can use "PARTITION BY EXPRESSION" instead of "FRAGMENT BY EXPRESSION" in CREATE TABLE, CREATE INDEX, and ALTER FRAGMENT ON INDEX statements as shown in this example:

```
ALTER FRAGMENT ON INDEX idx1 INIT PARTITION BY EXPRESSION
  PARTITION part1 (a <= 10) IN dbs1,
  PARTITION part2 (a <= 20) IN dbs1,
  PARTITION part3 (a <= 30) IN dbs1;
```

Use ALTER FRAGMENT syntax to change fragmented indexes that do not have partitions into indexes that have partitions. The syntax below shows how you might convert a fragmented index into an index that contains partitions:

```
CREATE TABLE t1 (c1 int) FRAGMENT BY EXPRESSION
  (c1=10) IN dbs1, (c1=20) IN dbs2, (c1=30) IN dbs3
CREATE INDEX ind1 ON t1 (c1) FRAGMENT BY EXPRESSION
  (c1=10) IN dbs1, (c1=20) IN dbs2, (c1=30) IN dbs3
ALTER FRAGMENT ON INDEX ind1 INIT FRAGMENT BY EXPRESSION
  PARTITION part_1 (c1=10) IN dbs1, PARTITION part_2 (c1=20) IN dbs1,
  PARTITION part_3 (c1=30) IN dbs1,
```

Creating a table or index containing partitions improves performance by enabling the database server to search more quickly and by reducing the required number of dbspaces.

The database server fragments the attached index according to the same distribution scheme as the table by using the same rule for index keys as for table data. As a result, attached indexes have the following physical characteristics:

- The number of index fragments is the same as the number of data fragments.
- Each attached index fragment resides in the same dbspace as the corresponding table data, but in a separate tblspace.
- An attached index or an index on a nonfragmented table uses 4 bytes for the row pointer for each index entry. For more information about how to estimate space for an index, see “Estimating index pages” on page 7-3.

Detached indexes

A *detached index* is an index with a separate fragmentation strategy that you set up explicitly with the CREATE INDEX statement.

The following sample SQL statements create a detached index:

```
CREATE TABLE tb1 (a int)
  FRAGMENT BY EXPRESSION
    (a <= 10) IN tabdbspc1,
    (a <= 20) IN tabdbspc2,
    (a <= 30) IN tabdbspc3;

CREATE INDEX idx1 ON tb1 (a)
  FRAGMENT BY EXPRESSION
    (a <= 10) IN idxdbspc1,
    (a <= 20) IN idxdbspc2,
    (a <= 30) IN idxdbspc3;
```

This example illustrates a common fragmentation strategy, to fragment indexes in the same way as the tables, but specify different dbspaces for the index fragments. This fragmentation strategy of putting the index fragments in different dbspaces from the table can improve the performance of operations such as backup, recovery, and so forth.

By default, all new indexes that the CREATE INDEX statement creates are detached and stored in separate tablespaces from the data unless the deprecated IN TABLE syntax is specified.

To create a detached index with partitions, include the partition name in your SQL statements, as shown in this example:

```
CREATE TABLE tb1 (a int)
  FRAGMENT BY EXPRESSION
    PARTITION part1 (a <= 10) IN dbs1,
    PARTITION part2 (a <= 20) IN dbs2,
    PARTITION part3 (a <= 30) IN dbs3;

CREATE INDEX idx1 ON tb1 (a)
  FRAGMENT BY EXPRESSION
    PARTITION part1 (a <= 10) IN dbs1,
    PARTITION part2 (a <= 20) IN dbs2,
    PARTITION part3 (a <= 30) IN dbs3;
```

You can use "PARTITION BY EXPRESSION" instead of "FRAGMENT BY EXPRESSION" in CREATE TABLE, CREATE INDEX, and ALTER FRAGMENT ON INDEX statements.

If you do not want to fragment the index, you can put the entire index in a separate dbspace.

You can fragment the index for any table by expression. However, you cannot explicitly create a round-robin fragmentation scheme for an index. Whenever you fragment a table using a round-robin fragmentation scheme, convert all indexes that accompany the table to detached indexes for the best performance.

Detached indexes have the following physical characteristics:

- Each detached index fragment resides in a different `tblspace` from the corresponding table data. Therefore, the data and index pages cannot be interleaved within the `tblspace`.
- Detached index fragments have their own extents and `tblspace` IDs. The `tblspace` ID is also known as the *fragment* ID and *partition number*. A detached index uses 8 bytes of disk space per index entry for the fragment ID and row pointer combination. For more information on how to estimate space for an index, see “Estimating index pages” on page 7-3.

The database server stores the location of each table and index fragment, along with other related information, in the system catalog table **sysfragments**. You can use the **sysfragments** system catalog table to access the following information about fragmented tables and indexes:

- The value in the **partn** field is the partition number or fragment id of the table or index fragment. The partition number for a detached index is different from the partition number of the corresponding table fragment.
- The value in the **strategy** field is the distribution scheme used in the fragmentation strategy.

For a complete description of field values that this **sysfragments** system catalog table contains, see the *IBM Informix Guide to SQL: Reference*. For information about how to use **sysfragments** to monitor your fragments, see “Monitoring fragment use” on page 9-27.

Restrictions on indexes for fragmented tables

If the database server scans a fragmented index, multiple index fragments must be scanned and the results merged together. (The exception is if the index is fragmented according to some index-key range rule, and the scan does not cross a fragment boundary.) Because of this requirement, performance on index scans might suffer if the index is fragmented.

Because of these performance considerations, the database server places the following restrictions on indexes:

- You cannot fragment indexes by round-robin.
- You cannot fragment unique indexes by an expression that contains columns that are not in the index key.

For example, the following statement is not valid:

```
CREATE UNIQUE INDEX ia on tab1(col1)
  FRAGMENT BY EXPRESSION
    col2<10 in dbsp1,
    col2>=10 AND col2<100 in dbsp2,
    col2>100 in dbsp3;
```

Strategy for fragmenting temporary tables

You can fragment an explicit temporary table across dbspaces that reside on different disks.

You can create a temporary, fragmented table with the TEMP TABLE clause of the CREATE TABLE statement. However, you cannot alter the fragmentation strategy of fragmented temporary tables (as you can with permanent tables). The database server deletes the fragments that are created for a temporary table at the same time that it deletes the temporary table.

You can define your own fragmentation strategy for an explicit temporary table, or you can let the database server dynamically determine the fragmentation strategy.

For more information about explicit and implicit temporary tables, see your *IBM Informix Administrator's Guide*.

Distribution schemes that eliminate fragments

Fragment elimination is a database server feature that reduces the number of fragments involved in a database operation. This capability can improve performance significantly and reduce contention for the disks on which fragments reside.

Fragment elimination improves both response time for a given query and concurrency between queries. Because the database server does not need to read in unnecessary fragments, I/O for a query is reduced. Activity in the LRU queues is also reduced.

If you use an appropriate distribution scheme, the database server can eliminate fragments from the following database operations:

- The fetch portion of the SELECT, INSERT, delete or update statements in SQL
The database server can eliminate fragments when these SQL statements are optimized, before the actual search.
- Nested-loop joins
When the database server obtains the key value from the outer table, it can eliminate fragments to search on the inner table.

Whether the database server can eliminate fragments from a search depends on two factors:

- The distribution scheme in the fragmentation strategy of the table that is being searched
- The form of the query expression (the expression in the WHERE clause of a SELECT, INSERT, delete or update statement)

Fragmentation expressions for fragment elimination

Some operators in expressions result in automatic fragment elimination.

When the fragmentation strategy is defined with any of the following operators, fragment elimination can occur for a query on the table.

IN
=
<
>
<=
>=
AND
OR
NOT
IS NULL (only when not combined with other expressions using AND or OR operators)

If the fragmentation expression uses any of the following operators, fragment elimination does not occur for queries on the table.

!=
IS NOT NULL

For examples of fragmentation expressions that allow fragment elimination, see “Effectiveness of fragment elimination” on page 9-15.

Query expressions for fragment elimination

A query expression (the expression in the WHERE clause) can consist of simple expressions, not simple expressions, and multiple expressions.

The database server considers only simple expressions or multiple simple expressions combined with certain operators for fragment elimination.

A simple expression consists of the following parts:

column operator value

Simple Expression Part Description

column Is a single column name

The database server supports fragment elimination on all column types except columns that are defined with the NCHAR, NVARCHAR, BYTE, and TEXT data types.

operator

Must be an equality or range operator

value Must be a literal or a host variable

The following examples show simple expressions:

```
name = "Fred"  
date < "08/25/2008"  
value >= :my_val
```

The following examples are not simple expressions:

```
unitcost * count > 4500  
price <= avg(price)  
result + 3 > :limit
```

The database server considers two types of simple expressions for fragment elimination, based on the operator:

- Range expressions
- Equality expressions

Range expressions in query

The database server can handle one or two column fragment elimination on queries with any combination of five relational operators in the WHERE clause.

Range expressions use the following relational operators:

<, >, <=, >=, !=

The database server can also eliminate fragments when these range expressions are combined with the following operators:

AND, OR, NOT
 IS NULL, IS NOT NULL
 MATCH, LIKE

If the range expression contains MATCH or LIKE, the database server can also eliminate fragments if the string ends with a wildcard character. The following examples show query expressions that can take advantage of fragment elimination:

```
columna MATCH "ab*"
columna LIKE "ab%" OR columnb LIKE "ab"
```

Equality expressions in query

The database server can handle one or multiple column fragment elimination on queries with a combination of equality operators in the WHERE clause.

Equality expressions use the following equality operators:

=, IN

The database server can also eliminate fragments when these equality expressions are combined with the following operators:

AND, OR

Effectiveness of fragment elimination

The database server cannot eliminate fragments when you fragment a table with a round-robin distribution scheme. Furthermore, not all expression-based distribution schemes give you the same fragment-elimination behavior.

Table 9-2 summarizes the fragment-elimination behavior for different combinations of expression-based distribution schemes and query expressions. Partitions in fragmented tables do not affect the fragment-elimination behavior shown below.

Table 9-2. Fragment elimination for different categories of expression-based distribution schemes and query expressions

Type of Expression-Based Distribution Scheme			
Type of Query (WHERE clause) Expression	Nonoverlapping Fragments on a Single Column	Overlapping or Non-contiguous Fragments on a Single Column	Nonoverlapping Fragments on Multiple Columns
Range expression	Fragments can be eliminated.	Fragments cannot be eliminated.	Fragments cannot be eliminated.
Equality expression	Fragments can be eliminated.	Fragments can be eliminated.	Fragments can be eliminated.

Table 9-2 indicates that the distribution schemes enable fragment elimination, but the effectiveness of fragment elimination is determined by the WHERE clause of the query in question.

For example, consider a table fragmented with the following expression:

```
FRAGMENT BY EXPRESSION
100 < column_a AND column_b < 0 IN dbsp1,
100 >= column_a AND column_b < 0 IN dbsp2,
column_b >= 0 IN dbsp3
```

The database server cannot eliminate any fragments from the search if the WHERE clause has the following expression:

```
column_a = 5 OR column_b = -50
```

On the other hand, the database server can eliminate the fragment in dbspace **dbsp3** if the WHERE clause has the following expression:

```
column_b = -50
```

Furthermore, the database server can eliminate the two fragments in dbspaces **dbsp2** and **dbsp3** if the WHERE clause has the following expression:

```
column_a = 5 AND column_b = -50
```

Partitions in fragmented tables do not affect fragment-elimination behavior.

The following sections discuss distribution schemes to fragment data to improve fragment elimination behavior.

Nonoverlapping fragments on a single column

A fragmentation rule that creates nonoverlapping fragments on a single column is the preferred fragmentation rule from a fragment-elimination standpoint.

The advantage of this type of distribution scheme is that the database server can eliminate fragments for queries with range expressions as well as queries with equality expressions. You should meet these conditions when you design your fragmentation rule. Figure 9-1 gives an example of this type of fragmentation rule.

```
...  
FRAGMENT BY EXPRESSION  
a<=8 OR a IN (9,10) IN dbsp1,  
10<a AND a<=20 IN dbsp2,  
a IN (21,22,23) IN dbsp3,  
a>23 IN dbsp4;
```

Figure 9-1. Example of nonoverlapping fragments on a single column

You can create nonoverlapping fragments using a range rule or an arbitrary rule based on a single column. You can use relational operators, as well as AND, IN, OR, or BETWEEN. Be careful when you use the BETWEEN operator. When the database server parses the BETWEEN keyword, it includes the end points that you specify in the range of values. Avoid using a REMAINDER clause in your expression. If you use a REMAINDER clause, the database server cannot always eliminate the remainder fragment.

Overlapping fragments on a single column

The fragments on a single column can be overlapping and noncontiguous. You can use any range, MOD function, or arbitrary rule that is based on a single column.

The only restriction for this category of fragmentation rule is that you base the fragmentation rule on a single column.

Figure 9-2 on page 9-17 shows an example of this type of fragmentation rule.

```
...  
FRAGMENT BY EXPRESSION  
a<=8 OR a IN (9,10,21,22,23) IN dbsp1,  
a>10 IN dbsp2;
```

Figure 9-2. Example of overlapping fragments on a single column

If you use this type of distribution scheme, the database server can eliminate fragments on an equality search but not a range search. This distribution scheme can still be useful because all INSERT and many UPDATE operations perform equality searches.

This alternative is acceptable if you cannot use an expression that creates nonoverlapping fragments with contiguous values. For example, in cases where a table is growing over time, you might want to use a MOD function rule to keep the fragments of similar size. Expression-based distribution schemes that use MOD function rules fall into this category because the values in each fragment are not contiguous.

Nonoverlapping fragments, multiple columns

The database server uses an arbitrary rule to define nonoverlapping fragments based on multiple columns.

The following figures show an example of nonoverlapping fragments on two columns.

```
...  
FRAGMENT BY EXPRESSION  
0<a AND a<=10 AND b IN ('E', 'F', 'G') IN dbsp1,  
0<a AND a<=10 AND b IN ('H', 'I', 'J') IN dbsp2,  
10<a AND a<=20 AND b IN ('E', 'F', 'G') IN dbsp3,  
10<a AND a<=20 AND b IN ('H', 'I', 'J') IN dbsp4,  
20<a AND a<=30 AND b IN ('E', 'F', 'G') IN dbsp5,  
20<a AND a<=30 AND b IN ('H', 'I', 'J') IN dbsp6;
```

Figure 9-3. Example of nonoverlapping fragments on two columns

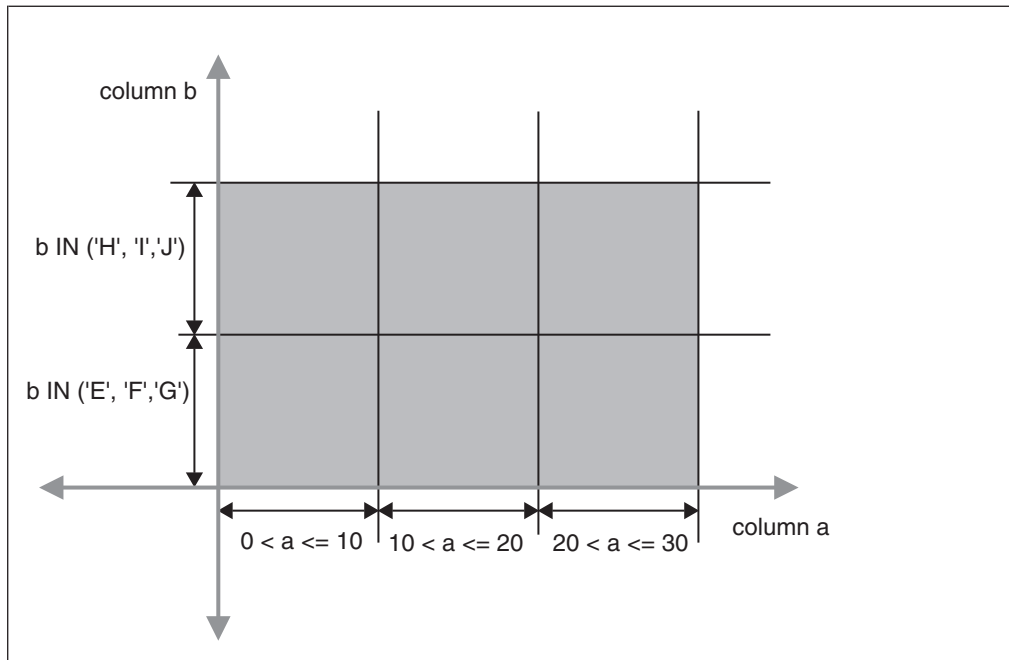

Figure 9-4. Schematic example of nonoverlapping fragments on two columns

If you use this type of distribution scheme, the database server can eliminate fragments on an equality search but not a range search. This capability can still be useful because all INSERT operations and many UPDATE operations perform equality searches. Avoid using a REMAINDER clause in the expression. If you use a REMAINDER clause, the database server cannot always eliminate the remainder fragment.

This alternative is acceptable if you cannot obtain sufficient granularity using an expression based on a single column.

Improve the performance of operations that attach and detach fragments

When you use ALTER FRAGMENT ATTACH and DETACH statements to add or remove a large amount of data in a very large table, you can take steps to improve the performance of the attach and detach operations.

The ALTER FRAGMENT DETACH statement provides a way to delete a segment of the table data rapidly. Similarly, the ALTER FRAGMENT ATTACH statement provides a way to load large amounts of data incrementally into an existing table by taking advantage of the fragmentation technology. However, the ALTER FRAGMENT ATTACH and DETACH statements can take a long time to execute when the database server rebuilds indexes on the surviving table.

The database server provides performance optimizations for the ALTER FRAGMENT ATTACH and DETACH statements that cause the database server to reuse the indexes on the surviving tables. Therefore, the database server can eliminate the index build during the attach or detach operation, which:

- Reduces the time that it takes for the ALTER FRAGMENT ATTACH and ALTER FRAGMENT DETACH statements to execute
- Improves the table availability

The ALTER FRAGMENT operation requires exclusive access and exclusive locks on all of the tables involved in the operation. If you enable the FORCE_DDL_EXEC environment option for a session, you can force out other transactions that have opened or have locks on the tables involved in an ALTER FRAGMENT ON TABLE operation. If the server is unable to get exclusive access and exclusive locks on the table, the server will start rolling back the transactions that are open or have locks on the table until the value specified with the FORCE_DDL_EXEC option is reached. You might want to enable the FORCE_DDL_EXEC environment option this on a busy system, perhaps one that runs 24 hours a day, and you do not want to wait for sessions to close before you alter a fragment.

Improving ALTER FRAGMENT ATTACH performance

You can take advantage of the performance optimizations for the ALTER FRAGMENT ATTACH statement if your database meets certain requirements.

To take advantage of the performance optimization, you must meet all of the following requirements:

- Formulate appropriate distribution schemes for your table and index fragments.
- Ensure that no data movement occurs between the resultant partitions due to fragment expressions.
- Update statistics for all the participating tables.
- Make the indexes on the attached tables unique if the index on the surviving table is unique.

Important: Only logging databases can benefit from the performance improvements for the ALTER FRAGMENT ATTACH statement. Without logging, the database server works with multiple copies of the same table to ensure recoverability of the data when a failure occurs. This requirement prevents reuse of the existing index fragments.

Distribution schemes for reusing indexes

You can use one of three distribution schemes that allow the attach operation of the ALTER FRAGMENT statement to reuse existing indexes.

These distributions schemes are:

- Fragmenting the index in the same way as the table
- Fragmenting the index with the same set of fragment expressions as the table
- Attaching unfragmented tables to form a fragmented table

Fragmenting the index in the same way as the table:

You fragment an index in the same way as the table when you create an index without specifying a fragmentation strategy.

A fragmentation strategy is the distribution scheme and set of dbspaces in which the fragments are located. For details, see “Planning a fragmentation strategy” on page 9-1.

Example of Fragmenting the Index in the Same Way as the Table

Suppose you create a fragmented table and index with the following SQL statements:

```

CREATE TABLE tb1(a int)
  FRAGMENT BY EXPRESSION
    (a >=0 AND a < 5) IN db1,
    (a >=5 AND a <10) IN db2;

CREATE INDEX idx1 ON tb1(a);

```

Suppose you then create another table that is not fragmented, and you subsequently decide to attach it to the fragmented table.

```

CREATE TABLE tb2 (a int, CHECK (a >=10 AND a<15))
  IN db3;

CREATE INDEX idx2 ON tb2(a)
  IN db3;

ALTER FRAGMENT ON TABLE tb1
  ATTACH
    tb2 AS (a >= 10 and a<15) AFTER db2;

```

This attach operation can take advantage of the existing index **idx2** if no data movement occurs between the existing and the new table fragments. If no data movement occurs:

- The database server reuses index **idx2** and converts it to a fragment of index **idx1**.
- The index **idx1** remains as an index with the same fragmentation strategy as the table **tb1**.

If the database server discovers that one or more rows in the table **tb2** belong to preexisting fragments of the table **tb1**, the database server:

- Drops and rebuilds the index **idx1** to include the rows that were originally in tables **tb1** and **tb2**
- Drops the index **idx2**

For more information about how to ensure no data movement between the existing and the new table fragments, see “Ensuring no data movement when you attach a fragment” on page 9-22.

Fragmenting the index with the same distribution scheme as the table:

You fragment an index with the same distribution scheme as the table when you create an index that uses the same fragment expressions as the table.

The database server determines if the fragment expressions are identical, based on the equivalency of the expression tree instead of the algebraic equivalence. For example, consider the following two expressions:

```

(col1 >= 5)
(col1 = 5 OR col1 > 5)

```

Although these two expressions are algebraically equivalent, they are not identical expressions.

Example of Fragmenting the Index with the Same Distribution Scheme as the Table

Suppose you create two fragmented tables and indexes with the following SQL statements:

```

CREATE TABLE tb1 (a INT)
  FRAGMENT BY EXPRESSION
    (a <= 10) IN tabdbspc1,
    (a <= 20) IN tabdbspc2,
    (a <= 30) IN tabdbspc3;
CREATE INDEX idx1 ON tb1 (a)
  FRAGMENT BY EXPRESSION
    (a <= 10) IN idxdbspc1,
    (a <= 20) IN idxdbspc2,
    (a <= 30) IN idxdbspc3;

CREATE TABLE tb2 (a INT CHECK a > 30 AND a <= 40)
  IN tabdbspc4;
CREATE INDEX idx2 ON tb2(a)
  IN idxdbspc4;

```

Suppose you then attach table **tb2** to table **tb1** with the following sample SQL statement:

```

ALTER FRAGMENT ON TABLE tb1
  ATTACH tb2 AS (a <= 40);

```

The database server can eliminate the rebuild of index **idx1** for this attach operation for the following reasons:

- The fragmentation expression for index **idx1** is identical to the fragmentation expression for table **tb1**. The database server:
 - Expands the fragmentation of the index **idx1** to the dbspace **idxdbspc4**
 - Converts index **idx2** to a fragment of index **idx1**
- No rows move from one fragment to another because the CHECK constraint is identical to the resulting fragmentation expression of the attached table. For more information about how to ensure no data movement between the existing and the new table fragments, see “Ensuring no data movement when you attach a fragment” on page 9-22.

Attaching unfragmented tables together:

You can take advantage of the performance benefits of the ALTER FRAGMENT ATTACH operation when you combine two unfragmented tables into one fragmented table.

For example, suppose you create two unfragmented tables and indexes with the following SQL statements:

```

CREATE TABLE tb1(a int) IN db1;
  CREATE INDEX idx1 ON tb1(a) in db1;
CREATE TABLE tb2(a int) IN db2;
  CREATE INDEX idx2 ON tb2(a) in db2;

```

You might want to combine these two unfragmented tables with the following sample distribution scheme:

```

ALTER FRAGMENT ON TABLE tb1
  ATTACH
    tb1 AS (a <= 100),
    tb2 AS (a > 100);

```

If no data migrates between the fragments of **tb1** and **tb2**, the database server redefines index **idx1** with the following fragmentation strategy:

```
CREATE INDEX idx1 ON tb1(a) F
  FRAGMENT BY EXPRESSION
    a <= 100 IN db1,
    a > 100 IN db2;
```

Important: This behavior results in a different fragmentation strategy for the index prior to Version 7.3 and Version 9.2 of the database server. In earlier versions, the ALTER FRAGMENT ATTACH statement creates an unfragmented detached index in the dbspace **db1**.

Ensuring no data movement when you attach a fragment

You can ensure there is no data movement when you attach a fragment by establishing identical check constraint expressions and verifying that fragment expressions are not overlapping.

To ensure that no data movement occurs when you attach a fragment:

1. Establish a check constraint on the attached table that is identical to the fragment expression that it will assume after the ALTER FRAGMENT ATTACH operation.
2. Define the fragments with nonoverlapping expressions.

For example, you might create a fragmented table and index with the following SQL statements:

```
CREATE TABLE tb1(a int)
  FRAGMENT BY EXPRESSION
    (a >=0 AND a < 5) IN db1,
    (a >=5 AND a <10) IN db2;
```

```
CREATE INDEX idx1 ON tb1(a);
```

Suppose you create another table that is not fragmented, and you subsequently decide to attach it to the fragmented table.

```
CREATE TABLE tb2 (a int, check (a >=10 and a<15))
  IN db3;
```

```
CREATE INDEX idx2 ON tb2(a)
  IN db3;
```

```
ALTER FRAGMENT ON TABLE tb1
  ATTACH
    tb2 AS (a >= 10 AND a<15) AFTER db2;
```

This ALTER FRAGMENT ATTACH operation takes advantage of the existing index **idx2** because the following steps were performed in the example to prevent data movement between the existing and the new table fragment:

- The check constraint expression in the CREATE TABLE **tb2** statement is identical to the fragment expression for table **tb2** in the ALTER FRAGMENT ATTACH statement.
- The fragment expressions specified in the CREATE TABLE **tb1** and the ALTER FRAGMENT ATTACH statements are not overlapping.

Therefore, the database server preserves index **idx2** in dbspace **db3** and converts it into a fragment of index **idx1**. The index **idx1** remains as an index with the same fragmentation strategy as the table **tb1**.

Indexes on attached tables

The database server tries to reuse the indexes on the attached tables as fragments of the resultant index. However, the corresponding index on the attached table

might not exist or might not be usable due to disk-format mismatches. In these cases, it might be faster to build an index on the attached tables rather than to build the entire index on the resultant table.

Informix estimates the cost to create the whole index on the resultant table. The server then compares this cost to the cost of building the individual index fragments for the attached tables and chooses the index build with the least cost.

Automatically Gathered Statistics for New Indexes

When the CREATE INDEX statement runs successfully, with or without the ONLINE keyword, Informix automatically gathers the following statistics for the newly created index:

- Index-level statistics, equivalent to the statistics gathered in the UPDATE STATISTICS operation in LOW mode, for all types of indexes, including B-tree, Virtual Index Interface, and functional indexes.
- Column-distribution statistics, equivalent to the distribution generated in the UPDATE STATISTICS operation in HIGH mode, for a non-opaque leading indexed column of an ordinary B-tree index. The resolution of the HIGH mode is 1.0 for a table size that is less than 1 million rows and 0.5 for higher table sizes. Tables with more than 1 million rows have a better resolution because they have more bins for statistics.

The automatically gathered distribution statistics are available to the query optimizer when it designs query plans for the table on which the new index was created.

Run UPDATE STATISTICS Before Attaching Tables

To ensure that cost estimates are correct, you should execute the UPDATE STATISTICS statement on all of the participating tables before you attach the tables. The LOW mode of the UPDATE STATISTICS statement is sufficient to derive the appropriate statistics for the optimizer to determine cost estimates for rebuilding indexes.

For more information about using the UPDATE STATISTICS statement, see the *IBM Informix Guide to SQL: Syntax*.

Example for situation when corresponding index does not exist:

When a table does not have an index on a column that can serve as the fragment of the resultant index, the database server estimates the cost of building the index fragment for the column, compares this cost to rebuilding the entire index for all fragments on the resultant table, and chooses the index build with the least cost.

Suppose you create a fragmented table and index with the following SQL statements:

```
CREATE TABLE tb1(a int, b int)
  FRAGMENT BY EXPRESSION
    (a >=0 AND a < 5) IN db1,
    (a >=5 AND a <10) IN db2;
CREATE INDEX idx1 ON tb1(a);
```

Suppose you then create two more tables that are not fragmented, and you subsequently decide to attach them to the fragmented table.

```

CREATE TABLE tb2 (a int, b int,
  CHECK (a >=10 and a<15)) IN db3;
CREATE INDEX idx2 ON tb2(a) IN db3;
CREATE TABLE tb3 (a int, b int,
  CHECK (a >= 15 and a<20)) IN db4;
CREATE INDEX idx3 ON tb3(b) IN db4;

ALTER FRAGMENT ON TABLE tb1
  ATTACH tb2 AS (a >= 10 and a<15) tb3 AS (a >= 15 and a<20);

```

The three CREATE INDEX statements automatically calculate distribution statistics for the leading column of each index in HIGH mode, as well as index statistics and table statistics in LOW mode.

The only time the UPDATE STATISTICS LOW FOR TABLE statement is required is after a CREATE INDEX statement in a situation in which the table has other preexisting indexes, as shown in this example:

```

CREATE TABLE tb1(col1 int, col2 int);
CREATE INDEX index idx1 on tb1(col1);
  (equivalent to update stats low on table tb1)
LOAD from tb1.unl insert into tb1; (load some data)
CREATE INDEX idx2 on tb1(col2);

```

The statement CREATE INDEX idx2 on tb1(col2) is NOT completely equivalent to UPDATE STATISTICS LOW FOR TABLE tb1, because the CREATE INDEX statement does not update index- level statistics for the preexisting index called idx1.

In the preceding example, table **tb3** does not have an index on column **a** that can serve as the fragment of the resultant index **idx1**. The database server estimates the cost of building the index fragment for column **a** on the consumed table **tb3** and compares this cost to rebuilding the entire index for all fragments on the resultant table. The database server chooses the index build with the least cost.

Example for situation when index on table is not usable:

When the index on a table is not usable, the database server estimates the cost of building the index fragment, compares this cost to rebuilding the entire index for all fragments on the resultant table, and chooses the index build with the least cost.

Suppose you create tables and indexes as in the previous section, but the index on the third table specifies a dbspace that the first table also uses. The following SQL statements show this scenario:

```

CREATE TABLE tb1(a int, b int)
  FRAGMENT BY EXPRESSION
    (a >=0 AND a < 5) IN db1,
    (a >=5 AND a <10) IN db2;
CREATE INDEX idx1 ON tb1(a);
CREATE TABLE tb2 (a int, b int, check (a >=10 and a<15))
  IN db3;
CREATE INDEX idx2 ON tb2(a)
  IN db3;

CREATE TABLE tb3 (a int, b int, check (a >= 15 and a<20))
  IN db4;
CREATE INDEX idx3 ON tb3(a)
  IN db2 ;

```

This example creates the index **idx3** on table **tb3** in the dbspace **db2**. As a result, index **idx3** is not usable because index **idx1** already has a fragment in the dbspace **db2**, and the fragmentation strategy does not allow more than one fragment to be specified in a given dbspace.

Again, the database server estimates the cost of building the index fragment for column **a** on the consumed table **tb3** and compares this cost to rebuilding the entire index **idx1** for all fragments on the resultant table. Then the database server chooses the index build with the least cost.

Improving ALTER FRAGMENT DETACH performance

You can improve the performance of ALTER FRAGMENT DETACH statements by formulating appropriate distribution schemes for your table and index fragments and by eliminating the index build during the execution of ALTER FRAGMENT DETACH statements.

To eliminate the index build during execution of the ALTER FRAGMENT DETACH statement, use one of the following fragmentation strategies:

- Fragment the index in the same way as the table.
- Fragment the index with the same distribution scheme as the table.

Important: Only logging databases can benefit from the performance improvements for the ALTER FRAGMENT DETACH statement. Without logging, the database server works with multiple copies of the same table to ensure recoverability of the data when a failure occurs. This requirement prevents reuse of the existing index fragments.

Fragmenting the index in the same way as the table

You fragment an index in the same way that you fragment the table when you create a fragmented table and subsequently create an index without specifying a fragmentation strategy.

For example, suppose you create a fragmented table and index with the following SQL statements:

```
CREATE TABLE tb1(a int)
  FRAGMENT BY EXPRESSION
    (a >=0 AND a < 5) IN db1,
    (a >=5 AND a <10) IN db2,
    (a >=10 AND a <15) IN db3;
CREATE INDEX idx1 ON tb1(a);
```

The database server fragments the index keys into dbspaces **db1**, **db2**, and **db3** with the same column **a** value ranges as the table because the CREATE INDEX statement does not specify a fragmentation strategy.

Suppose you then decide to detach the data in the third fragment with the following SQL statement:

```
ALTER FRAGMENT ON TABLE tb1
  DETACH db3 tb3;
```

Because the fragmentation strategy of the index is the same as the table, the ALTER FRAGMENT DETACH statement does not rebuild the index after the detach operation. The database server drops the fragment of the index in dbspace **db3**, updates the system catalog tables, and eliminates the index build.

Fragmenting the index using same distribution scheme as the table

You fragment an index with the same distribution scheme as the table when you create the index that uses the same fragment expressions as the table.

A common fragmentation strategy is to fragment indexes in the same way as the tables but to specify different dbspaces for the index fragments. This fragmentation strategy of putting the index fragments into different dbspaces from the table can improve the performance of operations such as backup, recovery, and so forth.

For example, suppose you create a fragmented table and index with the following SQL statements:

```
CREATE TABLE tb1(a int, b int)
  FRAGMENT BY EXPRESSION
    (a >=0 AND a < 5) IN db1,
    (a >=5 AND a <10) IN db2,
    (a >=10 AND a <15) IN db3;
```

```
CREATE INDEX idx1 on tb1(a)
  FRAGMENT BY EXPRESSION
    (a >=0 AND a< 5) IN db4,
    (a >=5 AND a< 10) IN db5,
    (a >=10 AND a<15) IN db6;
```

Suppose you then decide to detach the data in the third fragment with the following SQL statement:

```
ALTER FRAGMENT ON TABLE tb1
  DETACH db3 tb3;
```

Because the distribution scheme of the index is the same as the table, the ALTER FRAGMENT DETACH statement does not rebuild the index after the detach operation. The database server drops the fragment of the index in dspace **db3**, updates the system catalog tables, and eliminates the index build.

Forcing out transactions when altering table fragments

You can enable the server to force out transactions that have opened or have locks on the tables when you issue an ALTER FRAGMENT ON TABLE operation in a logging database. You might want to do this on a busy system, perhaps one that runs 24 hours a day, and you do not want to wait for sessions to close before you alter a fragment.

Be aware that if you enable the server to force out the transactions, the server will roll back other users' transactions. The server also closes the hold cursors during rollback by the session that performs the ALTER FRAGMENT ON TABLE operation.

Prerequisites:

- You must be user **informix** or have DBA privileges on the database.
- The table must be in a logging database.

To force out transactions when altering a table fragment:

1. Set the FORCE_DDL_EXEC environment option of the SET ENVIRONMENT statement to one of the following values:

- 'ON', 'on', or '1' to enable the server to force out transactions that are open or have a lock on the table when an ALTER FRAGMENT ON TABLE statement is issued until the server gets a lock and exclusive access on the table.
- A numeric positive integer that represents an amount of time in seconds. The numeric value enables the server to force out transactions until the server gets exclusive access and exclusive locks on the table or until the specified time limit occurs. If the server cannot force out transactions by the specified amount of time, the server stops attempting to force out the transactions.

For example, to enable the FORCE_DDL_EXEC environment option to operate for 100 seconds when an ALTER FRAGMENT ON TABLE statement is issued, specify:

```
SET ENVIRONMENT FORCE_DDL_EXEC '100';
```

2. Set the lock mode to wait to ensure that the server will wait a specified amount of time before forcing out any transactions.

For example, to set the lock mode to wait for 20 seconds, specify:

```
SET LOCK MODE TO WAIT 20;
```

For more information, see “Setting the lock mode to wait” on page 8-5.

3. Run an ALTER FRAGMENT ON TABLE statement, for example, to attach, detach, modify, add, or drop the fragment.

After you complete an ALTER FRAGMENT ON TABLE operation with the FORCE_DDL_EXEC environment option enabled, you can turn the FORCE_DDL_EXEC environment option off. For example, specify:

```
SET ENVIRONMENT FORCE_DDL_EXEC 'OFF'
```

For more information, see the topic on the FORCE_DDL_EXEC environment option in the *IBM Informix Guide to SQL: Syntax*.

Monitoring fragment use

Once you determine a fragmentation strategy, you can monitor fragmentation.

You can monitor fragmentation in the following ways:

- Run individual **onstat** utility commands to capture information about specific aspects of a running query.
- Run a SET EXPLAIN statement before you run a query to write the query plan to an output file.

Monitoring fragmentation with the onstat -g ppf command

With the **onstat -g ppf** command, you can view partition information and monitor the I/O activity to verify your strategy and determine whether the I/O is balanced across fragments.

The **onstat -g ppf** output includes the number of read-and-write requests sent to each fragment that is currently open. Because a request can trigger multiple I/O operations, these requests do not indicate how many individual disk I/O operations occur, but you can get a good idea of the I/O activity from the displayed columns.

The brfd column in the output displays the number of buffer reads in pages. (Each buffer can contain one page.) This information is useful if you need to monitor the time a query takes to execute. Typically query execution time has a strong

dependency on the number of required buffer reads. If the size of client-server buffering is small and your database contains TEXT data, query execution time can involve significantly more buffer reads, because the server reads the prior TEXT data.

The **onstat -g ppf** output by itself does not identify the table in which a fragment is located. To determine the table for the fragment, join the **partnum** column in the output to the **partnum** column in the **sysfragments** system catalog table. The **sysfragments** table displays the associated **table id**. You can also find the table name for the fragment by joining the **table id** column in **sysfragments** to the **table id** column in **systables**.

To determine the table name in onstat -g ppf output:

1. Obtain the value in the **partnum** field of the **onstat -g ppf** output.
2. Join the **tabid** column in the **sysfragments** system catalog table with the **tabid** column in the **systables** system catalog table to obtain the table name from **systables**.

Use the **partnum** field value that you obtain in step 1 in the SELECT statement.

```
SELECT a.tabname FROM systables a, sysfragments b
WHERE a.tabid = b.tabid
AND partn = partnum_value;
```

Monitoring fragmentation with SET EXPLAIN output

When the table is fragmented, the output of the SET EXPLAIN ON statement shows which table or index the database server scans to execute the query.

The SET EXPLAIN output identifies the fragments with a fragment number. The fragment numbers are the same as those contained in the **partn** column in the **sysfragments** system catalog table.

The following example of partial SET EXPLAIN output shows a query that takes advantage of fragment elimination and scans two fragments in table **t1**:

QUERY:

```
SELECT * FROM t1 WHERE c1 > 12
```

Estimated Cost: 3

Estimated # of Rows Returned: 2

1) informix.t1: SEQUENTIAL SCAN (Serial, fragments: 1, 2)

Filters: informix.t1.c1 > 12

If the optimizer must scan all fragments (that is, if it is unable to eliminate any fragment from consideration), the SET EXPLAIN output displays **fragments: ALL**. In addition, if the optimizer eliminates all the fragments from consideration (that is, none of the fragments contain the queried information), the SET EXPLAIN output displays **fragments: NONE**.

For information about how the database server eliminates a fragment from consideration, see “Distribution schemes that eliminate fragments” on page 9-13.

For more information about the SET EXPLAIN ON statement, see “Report that shows the query plan chosen by the optimizer” on page 10-9.

Chapter 10. Queries and the query optimizer

These topics describe query plans, explain how the database server manages query optimization, and discuss factors that you can use to influence the query plan. These topics also describe performance considerations for SPL routines, the UDR cache, and triggers.

The parallel database query (PDQ) features in the database server provide the largest potential performance improvements for a query. Chapter 12, “Parallel database query (PDQ),” on page 12-1 describes PDQ and the Memory Grant Manager (MGM) and explains how to control resource use by queries.

PDQ provides the most substantial performance gains if you fragment your tables as described in Chapter 9, “Fragmentation guidelines,” on page 9-1.

Chapter 13, “Improving individual query performance,” on page 13-1 explains how to improve the performance of specific queries.

Data warehouse queries and performance issues related to dimensional databases are described in the *IBM Informix Data Warehouse Guide*.

The query plan

The query optimizer evaluates the different ways in which a query might be performed and determines the best way to select the requested data. During this evaluation, the optimizer formulates a *query plan* to fetch the data rows that are required to process a query.

For example, when evaluating the different ways in which a query might be performed, the optimizer must determine whether indexes should be used. If the query includes a join, the optimizer must determine the join plan (hash or nested loop) and the order in which tables are evaluated or joined.

The following topics describe the components of a query plan and show examples of query plans.

The access plan

The way that the optimizer chooses to read a table is called an *access plan*. The simplest method to access a table is to read it sequentially, which is called a *table scan*. The optimizer chooses a table scan when most of the table must be read or the table does not have an index that is useful for the query.

The optimizer can also choose to access the table by an index. If the column in the index is the same as a column in a filter of the query, the optimizer can use the index to retrieve only the rows that the query requires. The optimizer can use a *key-only index scan* if the columns requested are within one index on the table. The database server retrieves the needed data from the index and does not access the associated table.

Important: The optimizer does not choose a key-only scan for a VARCHAR column. If you want to take advantage of key-only scans, use the ALTER TABLE with the MODIFY clause to change the column to a CHAR data type.

The optimizer compares the cost of each plan to determine the best one. The database server derives cost from estimates of the number of I/O operations required, calculations to produce the results, rows accessed, sorting, and so forth.

The join plan

When a query contains more than one table, Informix joins the tables using filters in the query. The way that the optimizer chooses to join the tables is the *join plan*.

In the following query, the customer and orders table are joined by the customer.customer_num = orders.customer_num filter:

```
SELECT * from customer, orders
WHERE customer.customer_num = orders.customer_num
AND customer.lname = "Higgins";
```

The join method can be a nested-loop join or a hash join.

Because of the nature of hash joins, an application with isolation level set to Repeatable Read might temporarily lock all the records in tables that are involved in the join, including records that fail to qualify the join. This situation leads to decreased concurrency among connections. Conversely, nested-loop joins lock fewer records but provide reduced performance when a large number of rows are accessed. Thus, each join method has advantages and disadvantages.

Nested-loop join

In a nested-loop join, the database server scans the first, or *outer table*, and then joins each of the rows that pass table filters to the rows found in the second, or *inner table*.

Figure 10-1 shows tables and rows, and the order they are read, for query:

```
SELECT * FROM customer, orders
WHERE customer.customer_num=orders.customer_num
AND order_date>"01/01/2007";
```

The database server accesses an outer table by an index or by a table scan. The database server applies any table filters first. For each row that satisfies the filters on the outer table, the database server reads the inner table to find a match.

The database server reads the inner table once for every row in the outer table that fulfills the table filters. Because of the potentially large number of times that the inner table can be read, the database server usually accesses the inner table by an index.

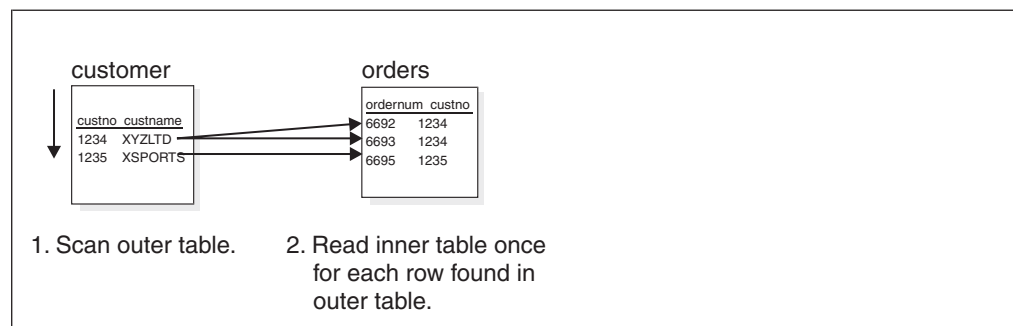

Figure 10-1. Nested-loop join

If the inner table does not have an index, the database server might construct an *autoindex* at the time of query execution. The optimizer might determine that the cost to construct an *autoindex* at the time of query execution is less than the cost to scan the inner table for each qualifying row in the outer table.

If the optimizer changes a subquery to a nested-loop join, it might use a variation of the nested-loop join, called a *semi join*. In a semi join, the database server reads the inner table only until it finds a match. In other words, for each row in the outer table, the inner table contributes at most one row. For more information on how the optimizer handles subqueries, see “Query plans for subqueries” on page 10-14.

Hash join

The optimizer usually uses a hash join when at least one of the two join tables does not have an index on the join column or when the database server must read a large number of rows from both tables. No index and no sorting is required when the database server performs a hash join.

A hash join consists of two activities: first building the hash table (*build phase*) and then probing the hash table (*probe phase*). Figure 10-2 shows the hash join in detail.

In the build phase, the database server reads one table and, after it applies any filters, creates a hash table. Think of a hash table conceptually as a series of *buckets*, each with an address that is derived from the key value by applying a hash function. The database server does not sort keys in a particular hash bucket.

Smaller hash tables can fit in the virtual portion of database server shared memory. The database server stores larger hash files on disk in the dbspace specified by the DBSPACETEMP configuration parameter or the **DBSPACETEMP** environment variable.

In the probe phase, the database server reads the other table in the join and applies any filters. For each row that satisfies the filters on the table, the database server applies the hash function on the key and probes the hash table to find a match.

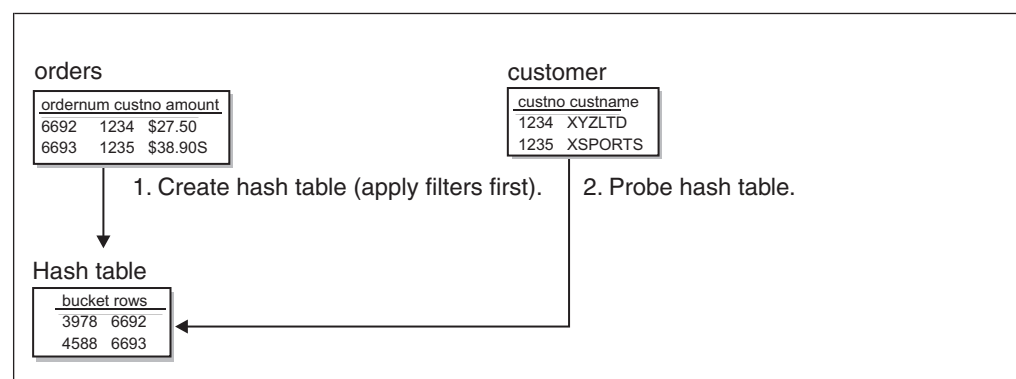

Figure 10-2. How a hash join is executed

Join order

The order that tables are joined in a query is extremely important. A poor join order can cause query performance to decline noticeably.

The following SELECT statement calls for a three-way join:

```

SELECT C.customer_num, O.order_num
FROM customer C, orders O, items I
WHERE C.customer_num = O.customer_num
AND O.order_num = I.order_num

```

The optimizer can choose one of the following join orders:

- Join **customer** to **orders**. Join the result to **items**.
- Join **orders** to **customer**. Join the result to **items**.
- Join **customer** to **items**. Join the result to **orders**.
- Join **items** to **customer**. Join the result to **orders**.
- Join **orders** to **items**. Join the result to **customer**.
- Join **items** to **orders**. Join the result to **customer**.

For an example of how the database server executes a plan according to a specific join order, see “Example of query-plan execution.”

Example of query-plan execution

This topic contains an example of a query with a SELECT statement that calls for a three-way join and describes one possible query plan.

The following SELECT statement calls for a three-way join:

```

SELECT C.customer_num, O.order_num
FROM customer C, orders O, items I
WHERE C.customer_num = O.customer_num
AND O.order_num = I.order_num

```

Assume also that no indexes are on any of the three tables. Suppose that the optimizer chooses the **customer-orders-items** path and the nested-loop join for both joins (in reality, the optimizer usually chooses a hash join for two tables without indexes on the join columns). Figure 10-3 shows the *query plan*, expressed in pseudocode. For information about interpreting query plan information, see “Report that shows the query plan chosen by the optimizer” on page 10-9.

```

for each row in the customer table do:
  read the row into C
  for each row in the orders table do:
    read the row into O
    if O.customer_num = C.customer_num then
      for each row in the items table do:
        read the row into I
        if I.order_num = O.order_num then
          accept the row and send to user
        end if
      end for
    end if
  end for
end for

```

Figure 10-3. A query plan in pseudocode

This procedure reads the following rows:

- All rows of the **customer** table once
- All rows of the **orders** table once for each row of the **customer** table
- All rows of the **items** table once for each row of the **customer-orders** pair

This example does not describe the only possible query plan. Another plan merely reverses the roles of **customer** and **orders**: for each row of **orders**, it reads all rows of **customer**, looking for a matching **customer_num**. It reads the same number of rows in a different order and produces the same set of rows in a different order. In this example, no difference exists in the amount of work that the two possible query plans need to do.

Example of a join with column filters

The presence of a *column filter* can change the query plan. A column filter is a WHERE expression that reduces the number of rows that a table contributes to a join.

The following example shows the query described in “Example of query-plan execution” on page 10-4 with a filter added:

```
SELECT C.customer_num, O.order_num
FROM customer C, orders O, items I
WHERE C.customer_num = O.customer_num
      AND O.order_num = I.order_num
      AND O.paid_date IS NULL
```

The expression `O.paid_date IS NULL` filters out some rows, reducing the number of rows that are used from the **orders** table. Consider a plan that starts by reading from **orders**. Figure 10-4 displays this sample plan in pseudocode.

```
for each row in the orders table do:
  read the row into O
  if O.paid_date is null then
    for each row in the customer table do:
      read the row into C
      if O.customer_num = C.customer_num then
        for each row in the items table do:
          read the row into I
          if I.order_num = O.order_num then
            accept row and return to user
          end if
        end for
      end if
    end for
  end if
end for
```

Figure 10-4. Query plan that uses a column filter

Let *pdnull* represent the number of rows in **orders** that pass the filter. It is the value of **COUNT(*)** that results from the following query:

```
SELECT COUNT(*) FROM orders WHERE paid_date IS NULL
```

If one customer exists for every order, the plan in Figure 10-4 reads the following rows:

- All rows of the **orders** table once
- All rows of the **customer** table, *pdnull* times
- All rows of the **items** table, *pdnull* times

Figure 10-5 on page 10-6 shows an alternative execution plan that reads from the **customer** table first.

```

for each row in the customer table do:
  read the row into C
  for each row in the orders table do:
    read the row into O
    if O.paid_date is null and
       O.customer_num = C.customer_num then
      for each row in the items table do:
        read the row into I
        if I.order_num = O.order_num then
          accept row and return to user
        end if
      end for
    end if
  end for
end for

```

Figure 10-5. The alternative query plan in pseudocode

Because the filter is not applied in the first step that Figure 10-5 shows, this plan reads the following rows:

- All rows of the **customer** table once
- All rows of the **orders** table once for every row of **customer**
- All rows of the **items** table, *pnull* times

The query plans in Figure 10-4 on page 10-5 and Figure 10-5 produce the same output in a different sequence. They differ in that one reads a table *pnull* times, and the other reads a table `SELECT COUNT(*) FROM customer` times. By choosing the appropriate plan, the optimizer can save thousands of disk accesses in a real application.

Example of a join with indexes

The presence of indexes and constraints in query plans provides the optimizer with options that can greatly improve query-execution time.

This topic shows the outline of a query plan that differs from query shown in “Example of a join with column filters” on page 10-5, because it is constructed using indexes.

```

for each row in the customer table do:
  read the row into C
  look up C.customer_num in index on orders.customer_num
  for each matching row in the orders index do:
    read the table row for O
    if O.paid_date is null then
      look up O.order_num in index on items.order_num
      for each matching row in the items index do:
        read the row for I
        construct output row and return to user
      end for
    end if
  end for
end for

```

Figure 10-6. Query plan with indexes

The keys in an index are sorted so that when the database server finds the first matching entry, it can read any other rows with identical keys without further searching, because they are located in physically adjacent positions. This query plan reads only the following rows:

- All rows of the **customer** table once
- All rows of the **orders** table once (because each order is associated with only one customer)
- Only rows in the **items** table that match *pdnull* rows from the **customer-orders** pairs

This query plan achieves a great reduction in cost compared with plans that do not use indexes. An inverse plan, reading **orders** first and looking up rows in the **customer** table by its index, is also feasible by the same reasoning.

The physical order of rows in a table also affects the cost of index use. To the degree that a table is ordered relative to an index, the overhead of accessing multiple table rows in index order is reduced. For example, if the **orders** table rows are physically ordered according to the customer number, multiple retrievals of orders for a given customer would proceed more rapidly than if the table were ordered randomly.

In some cases, using an index might incur additional costs. For more information, see “Index lookup costs” on page 10-25.

Query plans that include an index self-join path

An *index self-join* is a type of index scan that you can think of as a union of many small index scans, each one with a single unique combination of lead-key columns and filters on non-lead-key columns.

The union of small index scans results in an access path that uses only subsets of the full range of a composite index. The table is logically joined to itself, and the more selective non-leading index keys are applied as index-bound filters to each unique combination of the leading key values.

An index self-join is beneficial for situations in which:

- The lead key of an index has many duplicates, and
- Predicates on the lead key are not selective, but predicates on the non-leading index keys are selective.

The query in Figure 10-7 on page 10-8 shows the SET EXPLAIN output for a query plan that includes an index self-join path.

```

QUERY:
-----
SELECT a.c1,a.c2,a.c3 FROM tab1 a WHERE (a.c3 >= 100103) AND
      (a.c3 <= 100104) AND (a.c1 >= 'PICKED      ') AND
      (a.c1 <= 'RGA2      ') AND (a.c2 >= 1) AND (a.c2 <= 7)
      ORDER BY 1, 2, 3

Estimated Cost: 155
Estimated # of Rows Returned: 1
1) informix.a: INDEX PATH
   (1) Index Keys: c1 c2 c3 c4 c5   (Key-Only)   (Serial, fragments: ALL)
       Index Self Join Keys (c1 c2 )
           Lower bound: informix.a.c1 >= 'PICKED      ' AND (informix.a.c2 >= 1 )
           Upper bound: informix.a.c1 <= 'RGA2      ' AND (informix.a.c2 <= 7 )
       Lower Index Filter: (informix.a.c1 = informix.a.c1 AND
                           informix.a.c2 = informix.a.c2 ) AND informix.a.c3 >= 100103
       Upper Index Filter: informix.a.c3 <= 100104
       Index Key Filters:  (informix.a.c2 <= 7 ) AND
                           (informix.a.c2 >= 1 )

```

Figure 10-7. SET EXPLAIN output for a query with an index self-join path

In Figure 10-7, an index exists on columns c1, c2, c3, c4, and c5. The optimizer chooses c1 and c2 as lead keys, which implies that columns c1 and c2 have many duplicates. Column c3 has few duplicates and thus the predicates on column c3 (c3 >= 100103 and c3 <= 100104) have good selectivity.

As Figure 10-7 shows, an index self-join path is a self-join of two index scans using the same index. The first index scan retrieves each unique value for lead key columns, which are c1 and c2. The unique value of c1 and c2 is then used to probe the second index scan, which also uses predicates on column c3. Because predicates on column c3 have good selectivity:

- The index scan on the inner side of the nested-loop join is very efficient, retrieving only the few rows that satisfy the c3 predicates.
- The index scan does not retrieve extra rows.

Thus, for each unique value of c1 and c2, an efficient index scan on c1, c2 and c3 occurs.

The following lines in the example indicate that the optimizer has chosen an index self join path for this table, with columns c1 and c2 as the lead keys for the index self-join path:

```

Index Self Join Keys (c1 c2 )
      Lower bound: informix.a.c1 >= 'PICKED      ' AND (informix.a.c2 >= 1 )
      Upper bound: informix.a.c1 <= 'RGA2      ' AND (informix.a.c2 <= 7 )

```

The example shows the bounds for columns c1 and c2, which you can conceive of as the bounds for the index scan to retrieve the qualified leading keys of the index.

The following information in the example shows the self-join:

```
(informix.a.c1 = informix.a.c1 AND informix.a.c2 = informix.a.c2 )
```

This information represents the inner index scan. For lead key columns c1 and c2 the self-join predicate is used, indicating the value of c1 and c2 comes from the outer index scan. The predicates on column c3 serve as an index filter that makes the inner index scan efficient.

Regular index scans do not use filters on column c3 to position the index scan, because the lead key columns c1 and c2 do not have equality predicates.

The INDEX_SJ directive forces an index self-join path using the specified index, or choosing the least costly index in a list of indexes, even if data distribution statistics are not available for the leading index key columns. The AVOID_INDEX_SJ directive prevents a self-join path for the specified index or indexes. Also see “Access-method directives” on page 11-4 and the *IBM Informix Guide to SQL: Syntax*.

Query plan evaluation

The optimizer considers all query plans by analyzing factors such as disk I/O and CPU costs.

The optimizer constructs all feasible plans simultaneously using a bottom-up, breadth-first search strategy. That is, the optimizer first constructs all possible join pairs. It eliminates the more expensive pair of any *redundant* pair. (Redundant pairs are join pairs that contain the same tables and produce the same set of rows as another join pair.)

For example, if neither join specifies an ordered set of rows by using the ORDER BY or GROUP BY clauses of the SELECT statement, the join pair (A x B) is redundant with respect to (B x A).

If the query uses additional tables, the optimizer joins each remaining pair to a new table to form all possible join triplets, eliminating the more expensive of redundant triplets and so on for each additional table to be joined. When a non-redundant set of possible join combinations has been generated, the optimizer selects the plan that appears to have the lowest execution cost.

Report that shows the query plan chosen by the optimizer

Any user who runs a query can use the SET EXPLAIN statement or the EXPLAIN directive to display the query plan that the optimizer chooses.

For information about how to specify the directives, see “EXPLAIN directives” on page 11-10. The user enters the SET EXPLAIN ON statement or the SET EXPLAIN ON AVOID_EXECUTE statement before the SQL statement for the query, as the following example shows.

```
SET EXPLAIN ON AVOID_EXECUTE;  
SELECT * FROM customer, orders  
WHERE customer.customer_num = orders.customer_num  
      AND customer.lname = "Higgins";
```

If a user does not have any access to SQL code source, the Database Administrator can set dynamically the SET EXPLAIN using the **onmode -Y** command running the SQL code. See information about SET EXPLAIN in the *IBM Informix Administrator's Reference*.

After the database server executes the SET EXPLAIN ON statement or sets dynamically the SET EXPLAIN with **onmode -Y** command, the server writes an explanation of each query plan to a file for subsequent queries that the user enters.

For more information, see “The sqexplain.out file” on page 10-10. For information about the Query Statistics section of the **sqexplain.out** file, which provides a useful resource for debugging performance problems, see “Query statistics section

provides performance debugging information.” For a complete description of the output file, see the *IBM Informix Guide to SQL: Syntax*.

The **sqexplain.out** file

The SET EXPLAIN statement enables (or disables) recording measurements of queries in the current session, including the plan of the query optimizer, an estimate of the number of rows returned, and the relative cost of the query. The measurements appear in an output file.

UNIX Only

On UNIX, the database server writes the output of the SET EXPLAIN ON statement or the EXPLAIN directive to the **sqexplain.out** file.

If the client application and the database server are on the same computer, the **sqexplain.out** file is stored in the current directory. If you are using a Version 5.1 or earlier client application and the **sqexplain.out** file does not appear in the current directory, check your home directory for the file.

When the current database is on another computer, the **sqexplain.out** file is stored in your home directory on the remote host.

Windows Only

On Windows, the database server writes the output of the SET EXPLAIN ON statement or the EXPLAIN directive to the file **%INFORMIXDIR%\sqexpln\username.out**.

When you use the **onmode -Y** command to turn on SET EXPLAIN, the output is displayed in the **sqexplain.out.sessionid** file. If an **sqexplain.out** file already exists, the database server stops to use it until the administrator turns off the dynamic SET EXPLAIN for the session.

The **sqexplain.out** file tells you if external directives are in effect.

The following codes in the Query Statistics section of the **sqexplain.out** file provide information about external tables:

- **xlcnv** identifies an operation that is loading data from an external table and inserting the data into a base table. Here **x** = external table, **l** = loading, and **cnv** = converter
- **xucnv** identifies an operation that is unloading data from an external table and inserting the data into a base table. Here **x** = external table, **u** = unloading, and **cnv** = converter

The Query Statistics section of the **sqexplain.out** file is a useful resource for debugging performance problems. See “Query statistics section provides performance debugging information.”

For a complete description of the output, see the *IBM Informix Guide to SQL: Syntax*.

Query statistics section provides performance debugging information

If the EXPLAIN_STAT configuration parameter is enabled, a Query Statistics section appears in the **sqexplain.out** file that the SET EXPLAIN statement of SQL and the **onmode -Y session_id** command displays.

The Query Statistics section of the **sqexplain.out** file shows the estimated number of rows that the query plan expects to return, the actual number of returned rows,

and other information about the query. You can use this information, which provides an indication of the overall flow of the query plan and how many rows flow through each stage of the query, to debug performance problems.

The following example shows query statistics in SET EXPLAIN output. If the estimated and actual number of rows scanned or joined are quite different, the statistics on those tables might be old and should be updated.

```

select * from tab1, tab2 where tab1.c1 = tab2.c1 and tab1.c3 between 0 and 15

Estimated Cost: 104
Estimated # of Rows Returned: 69

1) zelaine.tab2: SEQUENTIAL SCAN
2) zelaine.tab1: INDEX PATH

(1) Index Keys: c1 c3 (Serial, fragments: ALL)
    Lower Index Filter: (zelaine.tab1.c1 = zelaine.tab2.c1
                        AND zelaine.tab1.c3 >= 0 )
    Upper Index Filter: zelaine.tab1.c3 <= 15
NESTED LOOP JOIN

Query statistics:
-----

Table map :
-----
Internal name      Table name
-----
t1                 tab2
t2                 tab1

type  table  rows_prod  est_rows  rows_scan  time      est_cost
-----
scan  t1      50          50        50         00:00:00  4

type  table  rows_prod  est_rows  rows_scan  time      est_cost
-----
scan  t2      67          69        4          00:00:00  2

type  rows_prod  est_rows  time      est_cost
-----
nljoin 67          70        00:00:00  104

```

Figure 10-8. Query statistics in SET EXPLAIN output

For additional sample reports, see “Sample query plan reports.”

Sample query plan reports

The topics in this section describe sample query plans that you might want to display when analyzing the performance of different kinds of queries.

Single-table query

This topic shows sample SET EXPLAIN output for a simple query and a complex query on a single table.

Figure 10-9 on page 10-12 shows SET EXPLAIN output for a simple query.

```

QUERY:
-----
SELECT fname, lname, company FROM customer

Estimated Cost: 2
Estimated # of Rows Returned: 28

1) virginia.customer: SEQUENTIAL SCAN

```

Figure 10-9. Partial SET EXPLAIN output for a simple query

Figure 10-10 shows SET EXPLAIN output for a complex query on the **customer** table.

```

QUERY:
-----
SELECT fname, lname, company FROM customer
WHERE company MATCHES 'Sport*' AND
      customer_num BETWEEN 110 AND 115
ORDER BY lname

Estimated Cost: 1
Estimated # of Rows Returned: 1
Temporary Files Required For: Order By

1) virginia.customer: INDEX PATH

      Filters: virginia.customer.company MATCHES 'Sport*'

(1) Index Keys: customer_num (Serial, fragments: ALL)
      Lower Index Filter: virginia.customer.customer_num >= 110
      Upper Index Filter: virginia.customer.customer_num <= 115

```

Figure 10-10. Partial SET EXPLAIN output for a complex query

The following output lines in Figure 10-10 show the scope of the index scan for the second query:

- Lower Index Filter: virginia.customer.customer_num >= 110
Start the index scan with the index key value of 110.
- Upper Index Filter: virginia.customer.customer_num <= 115
Stop the index scan with the index key value of 115.

Multitable query

This topic shows sample SET EXPLAIN output for a multiple-table query.

```

QUERY:
-----
SELECT C.customer_num, O.order_num, SUM (I.total_price)
FROM customer C, orders O, items I
WHERE C.customer_num = O.customer_num
AND O.order_num = I.order_num
GROUP BY C.customer_num, O.order_num

Estimated Cost: 78
Estimated # of Rows Returned: 1
Temporary Files Required For: Group By

1) virginia.o: SEQUENTIAL SCAN

2) virginia.c: INDEX PATH
   (1) Index Keys: customer_num (Key-Only) (Serial, fragments: ALL)
       Lower Index Filter:
           virginia.c.customer_num = virginia.o.customer_num
NESTED LOOP JOIN

3) virginia.i: INDEX PATH
   (1) Index Keys: order_num (Serial, fragments: ALL)
       Lower Index Filter: virginia.o.order_num = virginia.i.order_num
NESTED LOOP JOIN

```

Figure 10-11. Partial SET EXPLAIN output for a multi-table query

The SET EXPLAIN output lists the order in which the database server accesses the tables and the access plan to read each table. The plan in Figure 10-11 indicates that the database server is to perform the following actions:

1. The database server is to read the **orders** table first.
Because no filter exists on the **orders** table, the database server must read all rows. Reading the table in physical order is the least expensive approach.
2. For each row of **orders**, the database server is to search for matching rows in the **customer** table.
The search uses the index on **customer_num**. The notation **Key-Only** means that only the index need be read for the **customer** table because only the **c.customer_num** column is used in the join and the output, and the column is an index key.
3. For each row of **orders** that has a matching **customer_num**, the database server is to search for a match in the **items** table using the index on **order_num**.

Key-first scan

This topic shows a sample query that uses a *key-first scan*, which is an index scan that uses keys other than those listed as lower and upper index filters.

```

create index idx1 on tab1(c1, c2);

select * from tab1 where (c1 > 0) and ( (c2 = 1) or (c2 = 2))
Estimated Cost: 4
Estimated # of Rows Returned: 1

1) pubs.tab1: INDEX PATH

    (1) Index Keys: c1 c2 (Key-First) (Serial, fragments: ALL)
    Lower Index Filter: pubs.tab1.c1 > 0
    Index Key Filters: (pubs.tab1.c2 = 1 OR pubs.tab1.c2 = 2)

```

Figure 10-12. Partial SET EXPLAIN output for a key-first scan

Even though in this example the database server must eventually read the row data to return the query results, it attempts to reduce the number of possible rows by applying additional key filters first. The database server uses the index to apply the additional filter, `c2 = 1 OR c2 = 2`, before it reads the row data.

Query plans for subqueries

The optimizer can change a subquery to a join automatically if the join provides a lower cost.

For example, Figure 10-13 sample output of the SET EXPLAIN ON statement shows that the optimizer changes the table in the subquery to be the inner table in a join.

```

QUERY:
-----
SELECT company, fname, lname, phone
FROM customer c
WHERE EXISTS(
  SELECT customer_num FROM cust_calls u
  WHERE c.customer_num = u.customer_num)

Estimated Cost: 6
Estimated # of Rows Returned: 7

1) virginia.c: SEQUENTIAL SCAN

2) virginia.u: INDEX PATH (First Row)

    (1) Index Keys: customer_num call_dtime (Key-Only)
        (Serial, fragments: ALL)
    Lower Index Filter: virginia.c.customer_num = virginia.u.customer_num
NESTED LOOP JOIN (Semi Join)

```

Figure 10-13. Partial SET EXPLAIN output for a flattened subquery

For more information about the SET EXPLAIN ON statement, see “Report that shows the query plan chosen by the optimizer” on page 10-9.

When the optimizer changes a subquery to a join, it can use several variations of the access plan and the join plan:

- First-row scan
 - A first-row scan is a variation of a table scan. When the database server finds one match, the table scan halts.
- Skip-duplicate-index scan

The skip-duplicate-index scan is a variation of an index scan. The database server does not scan duplicates.

- Semi join

The semi join is a variation of a nested-loop join. The database server halts the inner-table scan when the first match is found. For more information about a semi join, see “Nested-loop join” on page 10-2.

Query plans for collection-derived tables

A collection-derived table is a special method that the database server uses to process a query on a collection. To use a collection-derived table, a query must contain the TABLE keyword in the FROM clause of an SQL statement.

For more information about how to use collection-derived tables in an SQL statement, see the *IBM Informix Guide to SQL: Syntax*.

Although the database does not actually create a table for the collection, it processes the data as if it were a table. Collection-derived tables allow developers to use fewer cursors and host variables to access a collection, in some cases.

These SQL statements create a collection column called **children**:

```
CREATE ROW TYPE person(name CHAR(255), id INT);
CREATE TABLE parents(name CHAR(255),
id INT,
children LIST(person NOT NULL));
```

The following query creates a collection-derived table for the **children** column and treats the elements of this collection as rows in a table:

```
SELECT name, id
FROM TABLE(MUTLISET(SELECT children
FROM parents
WHERE parents.id
= 1001)) c_table(name, id);
```

Alternatively, you can specify a collection-derived table in the FROM clause, as shown in this example:

```
SELECT name, id
FROM (SELECT children
FROM parents
WHERE parents.id
= 1001) c_table(name, id);
```

Example showing how the database server completes the query:

Informix performs several steps when completing a query for collection-derived tables.

When completing a query, the database server performs the steps shown in this example:

1. Scans the **parent** table to find the row where `parents.id = 1001`
This operation is listed as a SEQUENTIAL SCAN in the SET EXPLAIN output that Figure 10-14 on page 10-16 shows.
2. Reads the value of the collection column called **children**.
3. Scans the single collection and returns the value of **name** and **id** to the application.

This operation is listed as a COLLECTION SCAN in the SET EXPLAIN output that Figure 10-14 on page 10-16 shows.

```

QUERY:
-----
SELECT name, id
FROM (SELECT children
FROM parents
WHERE parents.id
= 1001) c_table(name, id);

Estimated Cost: 2
Estimated # of Rows Returned: 1

1) lsuto.c_table: COLLECTION SCAN
   Subquery:
   -----
   Estimated Cost: 1
   Estimated # of Rows Returned: 1

      1) lsuto.parents: SEQUENTIAL SCAN

         Filters: lsuto.parents.id = 1001

```

Figure 10-14. Query plan that uses a collection-derived table

Derived tables folded into parent queries:

You can improve the performance of collection-derived tables by using SQL to fold derived tables in simple queries into a parent query instead of into query results that are put into a temporary table.

Use SQL like that in this example:

```
select * from ((select col1, col2 from tab1)) as vtab(c1,c2)
```

However, if the query is complex because it involves aggregates, ORDER BY operations, or the UNION operation, the server creates a temporary table.

The database server folds derived tables in a manner that is similar to the way the server folds views through the IFX_FOLDVIEW configuration parameter (described in “Enable view folding to improve query performance” on page 13-30). When the IFX_FOLDVIEW configuration parameter is enabled, views are folded into a parent query. The views are not folded into query results that are put into a temporary table.

The following examples show derived tables folded into the main query.

```

select * from ((select vcol0, tab1.col1 from
                table(multiset(select col2 from tab2 where col2 > 50 ))
                vtab2(vcol0),tab1 )) vtab1(vcol1,vcol2)
where vcol1 = vcol2

Estimated Cost: 2
Estimated # of Rows Returned: 1

1) informix.tab2: SEQUENTIAL SCAN
    Filters: informix.tab2.col2 > 50

2) informix.tab1: SEQUENTIAL SCAN
    Filters:
    Table Scan Filters: informix.tab1.col1 > 50

DYNAMIC HASH JOIN
    Dynamic Hash Filters: informix.tab2.col2 = informix.tab1.col1

```

Figure 10-15. Query plan that uses a derived table folded into the parent query

```

select * from (select col1 from tab1 where col1 = 100) as vtab1(c1)
left join (select col1 from tab2 where col1 = 10) as vtab2(vc1)
on vtab1.c1 = vtab2.vc1

Estimated Cost: 5
Estimated # of Rows Returned: 1

1) informix.tab1: SEQUENTIAL SCAN
    Filters: informix.tab1.col1 = 100

2) informix.tab2: AUTOINDEX PATH
    (1) Index Keys: col1 (Key-Only)
        Lower Index Filter: informix.tab1.col1 = informix.tab2.col1
        Index Key Filters: (informix.tab2.col1 = 10 )

ON-Filters:(informix.tab1.col1 = informix.tab2.col1
            AND informix.tab2.col1 = 10 )
NESTED LOOP JOIN(LEFT OUTER JOIN)

```

Figure 10-16. Second query plan that uses a derived table folded into the parent query

The following example shows a complex query involving the UNION operation. Here, a temporary table has been created.

```

select * from (select col1 from tab1 union select col2 from tab2 )
as vtab(vcol1) where vcol1 < 50

Estimated Cost: 4
Estimated # of Rows Returned: 1

1) (Temp Table For Collection Subquery): SEQUENTIAL SCAN

```

Figure 10-17. Complex derived-table query that creates a temporary table

XML query plans in IBM Data Studio

IBM Data Studio consists of a set of tools to use for administration, data modeling, and building queries from data that comes from data servers. The EXPLAIN_SQL routine prepares a query and returns a query plan in XML. The IBM Data Studio Administration Edition can use the EXPLAIN_SQL routine to obtain a query plan in XML format, interpret the XML, and render the plan visually.

If you plan to use IBM Data Studio to obtain Visual Explain output, you must create and specify a default sbspace name for the SBSPACENAME configuration parameter in your ONCONFIG file. The EXPLAIN_SQL routine creates BLOBs in this sbspace.

For information about using IBM Data Studio, see IBM Data Studio documentation.

Factors that affect the query plan

When the optimizer determines the query plan, it assigns a cost to each possible plan and then chooses the plan with the lowest cost. The optimizer analyzes several factors to determine the cost of each query plan.

Some of the factors that the optimizer uses to determine the cost of each query plan are:

- The number of I/O requests that are associated with each file system access
- The CPU work that is required to determine which rows meet the query predicate
- The resources that are required to sort or group the data
- The amount of memory available for the query (specified by the DS_TOTAL_MEMORY and DS_MAX_QUERIES parameters)

To calculate the cost of each possible query plan, the optimizer:

- Uses a set of statistics that describes the nature and physical characteristics of the table data and indexes
- Examines the query filters
- Examines the indexes that could be used in the plan
- Uses the cost of moving data to perform joins locally or remotely for distributed queries

Statistics held for the table and index

The accuracy with which the query optimizer can assess the execution cost of a query plan depends on the information available to the optimizer. Use the UPDATE STATISTICS statement to maintain simple statistics about a table and its associated indexes. Updated statistics provide the query optimizer with information that can minimize the amount of time required to perform queries on that table.

The database server starts a statistical profile of a table when the table is created, and the profile is refreshed when you issue the UPDATE STATISTICS statement. The query optimizer does not recalculate the profile for tables automatically. In some cases, gathering the statistics might take longer than executing the query.

To ensure that the optimizer selects a query plan that best reflects the current state of your tables, run `UPDATE STATISTICS` at regular intervals. For guidelines, see “Update statistics when they are not generated automatically” on page 13-11.

The optimizer uses the following system catalog information as it creates a query plan:

- The number of rows in a table, as of the most recent `UPDATE STATISTICS` statement
- Whether a column is constrained to be unique
- The distribution of column values, when requested with the `MEDIUM` or `HIGH` keyword in the `UPDATE STATISTICS` statement
For more information about data distributions, see “Creating data distributions” on page 13-13.
- The number of disk pages that contain row data

The optimizer also uses the following system catalog information about indexes:

- The indexes that exist on a table, including the columns that they index, whether they are ascending or descending, and whether they are clustered
- The depth of the index structure (a measure of the amount of work that is needed to perform an index lookup)
- The number of disk pages that index entries occupy
- The number of unique entries in an index, which can be used to estimate the number of rows that an equality filter returns
- Second-largest and second-smallest key values in an indexed column

Only the second-largest and second-smallest key values are noted, because the extreme values might have a special meaning that is not related to the rest of the data in the column. The database server assumes that key values are distributed evenly between the second largest and second smallest. Only the initial 4 bytes of these keys are stored. If you create a distribution for a column associated with an index, the optimizer uses that distribution when it estimates the number of rows that match a query.

For more information about system catalog tables, see the *IBM Informix Guide to SQL: Reference*.

Filters in the query

The query optimizer bases query-cost estimates on the number of rows to be retrieved from each table. In turn, the estimated number of rows is based on the *selectivity* of each conditional expression that is used within the `WHERE` clause. A conditional expression that is used to select rows is termed a *filter*.

The selectivity is a value between 0 and 1 that indicates the proportion of rows within the table that the filter can pass. A selective filter, one that passes few rows, has a selectivity near 0, and a filter that passes almost all rows has a selectivity near 1. For guidelines on filters, see “Improve filter selectivity” on page 13-2.

The optimizer can use data distributions to calculate selectivity for the filters in a query. However, in the absence of data distributions, the database server calculates selectivity for filters of different types based on table indexes. The following table lists some of the selectivity values that the optimizer assigns to filters of different types. Selectivity that is calculated using data distributions is even more accurate than the selectivity that this table shows.

Filter Expression	Selectivity (F)
<i>indexed-col = literal-value</i> <i>indexed-col = host-variable</i> <i>indexed-col IS NULL</i>	$F = 1/(\text{number of distinct keys in index})$
<i>tab1.indexed-col = tab2.indexed-col</i>	$F = 1/(\text{number of distinct keys in the larger index})$
<i>indexed-col > literal-value</i>	$F = (2\text{nd-max} - \text{literal-value}) / (2\text{nd-max} - 2\text{nd-min})$
<i>indexed-col < literal-value</i>	$F = (\text{literal-value} - 2\text{nd-min}) / (2\text{nd-max} - 2\text{nd-min})$
<i>any-col IS NULL</i> <i>any-col = any-expression</i>	$F = 1/10$
<i>any-col > any-expression</i> <i>any-col < any-expression</i>	$F = 1/3$
<i>any-col MATCHES any-expression</i> <i>any-col LIKE any-expression</i>	$F = 1/5$
EXISTS <i>subquery</i>	$F = 1$ if <i>subquery</i> estimated to return >0 rows, else 0
NOT <i>expression</i>	$F = 1 - F(\text{expression})$
<i>expr1</i> AND <i>expr2</i>	$F = F(\text{expr1}) \times F(\text{expr2})$
<i>expr1</i> OR <i>expr2</i>	$F = F(\text{expr1}) + F(\text{expr2}) - (F(\text{expr1}) \times F(\text{expr2}))$
<i>any-col</i> IN <i>list</i>	Treated as <i>any-col = item₁</i> OR . . . OR <i>any-col = item_n</i> .
<i>any-col</i> <i>relop</i> ANY <i>subquery</i>	Treated as <i>any-col relop value₁</i> OR . . . OR <i>any-col relop value_n</i> for estimated size of <i>subquery n</i> .

Here *relop* is any relational operator, such as <, >, >=, <=.

Key:

- *indexed-col*: first or only column in an index
- *2nd-max, 2nd-min*: second-largest and second-smallest key values in indexed column

In this table, the plus sign (+) means logical union (= the Boolean OR operator) and the multiplication symbol (x) means logical intersection (= the Boolean AND operator).

Indexes for evaluating a filter

The query optimizer notes whether an index can be used to evaluate a filter. For this purpose, an indexed column is any single column with an index or the first column named in a composite index.

If the values contained in the index are all that is required, the database server does not read the rows. It is faster to omit the page lookups for data pages whenever the database server can read values directly from the index.

The optimizer can choose an index for any one of the following cases:

- When the column is indexed and a value to be compared is a literal, a host variable, or an uncorrelated subquery

The database server can locate relevant rows in the table by first finding the row in an appropriate index. If an appropriate index is not available, the database server must scan each table in its entirety.

- When the column is indexed and the value to be compared is a column in another table (a join expression)

The database server can use the index to find matching values. The following join expression shows such an example:

```
WHERE customer.customer_num = orders.customer_num
```

If rows of **customer** are read first, values of **customer_num** can be applied to an index on **orders.customer_num**.

- When processing an ORDER BY clause

If all the columns in the clause appear in the required sequence within a single index, the database server can use the index to read the rows in their ordered sequence, thus avoiding a sort.

- When processing a GROUP BY clause

If all the columns in the clause appear in one index, the database server can read groups with equal keys from the index without requiring additional processing after the rows are retrieved from their tables.

Effect of PDQ on the query plan

When the parallel database query (PDQ) feature is turned on, the optimizer can choose to execute a query in parallel. This can improve performance dramatically when the database server processes queries that decision-support applications initiate.

For more information, see Chapter 12, “Parallel database query (PDQ),” on page 12-1.

Effect of OPTCOMPIND on the query plan

The OPTCOMPIND setting influences the access plan that the optimizer chooses for single and multiple-table queries. You can change the value of OPTCOMPIND within a session for different kinds of queries.

To change the value of OPTCOMPIND within a session, use the SET ENVIRONMENT OPTCOMPIND command, not the OPTCOMPIND configuration parameter. For more information about using this command, see “Setting the value of OPTCOMPIND within a session” on page 3-10.

Single-table query

For single-table scans, when OPTCOMPIND is set to 0 or 1 and the current transaction isolation level is Repeatable Read, the optimizer considers two types of access plans.

If:

- An index is available, the optimizer uses it to access the table.
- No index is available, the optimizer considers scanning the table in physical order.

When OPTCOMPIND is not set in the database server configuration, its value defaults to 2. When OPTCOMPIND is set to 2 or 1 and the current isolation level is not Repeatable Read, the optimizer chooses the least expensive plan to access the table.

Multitable query

For join plans, the OPTCOMPIND setting influences the access plan for a specific ordered pair of tables.

Set OPTCOMPIND to 0 if you want the database server to select a join method exactly as it did in previous versions of the database server. This option ensures compatibility with previous versions.

If OPTCOMPIND is set to 0 or set to 1 and the current transaction isolation level is Repeatable Read, the optimizer gives preference to the nested-loop join.

Important: When OPTCOMPIND is set to 0, the optimizer does not choose a hash join.

If OPTCOMPIND is set to 2 or set to 1 and the transaction isolation level is not Repeatable Read, the optimizer chooses the least expensive query plan from among those previously listed and gives no preference to the nested-loop join.

Effect of available memory on the query plan

Informix constrains the amount of memory that a parallel query can use based on the values of the DS_TOTAL_MEMORY and DS_MAX_QUERIES configuration parameters. If the amount of memory available for the query is too low to execute a hash join, the database server uses a nested-loop join instead.

For more information about parallel queries and the DS_TOTAL_MEMORY and DS_MAX_QUERIES parameters, see Chapter 12, “Parallel database query (PDQ),” on page 12-1.

Time costs of a query

You can adjust a few, but not all, of the response-time effects of actions that the database server performs when processing a query.

The following costs can be reduced by optimal query construction and appropriate indexes:

- Sort time
- Data mismatches
- In-place ALTER TABLE
- Index lookups

For information about how to optimize specific queries, see Chapter 13, “Improving individual query performance,” on page 13-1.

Memory-activity costs

The database server can process only data in memory. It must read rows into memory to evaluate those rows against the filters of a query. After the server finds rows that satisfy those filters, it prepares an output row in memory by assembling the selected columns.

Most of these activities are performed quickly. Depending on the computer and its workload, the database server can perform hundreds or even thousands of comparisons each second. As a result, the time spent on in-memory work is usually a small part of the execution time.

Although some in-memory activities, such as sorting, take a significant amount of time, it takes much longer to read a row from disk than to examine a row that is already in memory.

Sort-time costs

A sort requires in-memory work as well as disk work. The in-memory work depends on the number of columns that are sorted, the width of the combined sort key, and the number of row combinations that pass the query filter. You can reduce the cost of sorting.

You can use the following formula to calculate the in-memory work that a sort operation requires:

$$W_m = (c * N_{fr}) + (w * N_{fr} \log_2(N_{fr}))$$

W_m is the in-memory work.

c is the number of columns to order and represents the costs to extract column values from the row and concatenate them into a sort key.

w is proportional to the width of the combined sort key in bytes and stands for the work to copy or compare one sort key. A numeric value for w depends strongly on the computer hardware in use.

N_{fr} is the number of rows that pass the query filter.

Sorting can involve writing information temporarily to disk if the amount of data to sort is large. You can direct the disk writes to occur in the operating-system file space or in a dbspace that the database server manages. For details, see “Configure dbspaces for temporary tables and sort files” on page 5-8.

The disk work depends on the number of disk pages where rows appear, the number of rows that meet the conditions of the query predicate, the number of rows that can be placed on a sorted page, and the number of merge operations that must be performed. Use the following formula to calculate the disk work that a sort operation requires:

$$W_d = p + (N_{fr}/N_{rp}) * 2 * (m - 1)$$

W_d is the disk work.

p is the number of disk pages.

N_{fr} is the number of rows that pass the filters.

N_{rp} is the number of rows that can be placed on a page.

m represents the number of *levels of merge* that the sort must use.

The factor m depends on the number of sort keys that can be held in memory. If there are no filters, N_{fr}/N_{rp} is equivalent to p .

When all the keys can be held in memory, $m=1$ and the disk work is equivalent to p . In other words, the rows are read and sorted in memory.

For moderate to large tables, rows are sorted in batches that fit in memory, and then the batches are merged. When $m=2$, the rows are read, sorted, and written in batches. Then the batches are read again and merged, resulting in disk work proportional to the following value:

$$W_d = p + (2 * (N_{fr}/N_{rp}))$$

The more specific the filters, the fewer the rows that are sorted. As the number of rows increases, and the amount of memory decreases, the amount of disk work increases.

To reduce the cost of sorting, use the following methods:

- Make your filters as specific (selective) as possible.
- Limit the projection list to the columns that are relevant to your problem.

Row-reading costs

When the database server needs to examine a row that is not already in memory, it must read that row from disk. The database server does not read only one row; it reads the entire page that contains the row. If the row spans more than one page, it reads all of the pages.

The actual cost of reading a page is variable and hard to predict. The actual cost is a combination of the factors shown in the following table.

Factor	Effect of Factor
Buffering	If the needed page is in a page buffer already, the cost to read is nearly zero.
Contention	If two or more applications require access to the disk hardware, I/O requests can be delayed.
Seek time	The slowest thing that a disk does is to <i>seek</i> ; that is, to move the access arm to the track that holds the data. Seek time depends on the speed of the disk and the location of the disk arm when the operation starts. Seek time varies from zero to nearly a second.
Latency	The transfer cannot start until the beginning of the page rotates under the access arm. This <i>latency</i> , or rotational delay, depends on the speed of the disk and on the position of the disk when the operation starts. Latency can vary from zero to a few milliseconds.

The time cost of reading a page can vary from microseconds for a page that is already in a buffer, to a few milliseconds when contention is zero and the disk arm is already in position, to hundreds of milliseconds when the page is in contention and the disk arm is over a distant cylinder of the disk.

Sequential access costs

Disk costs are lowest when the database server reads the rows of a table in physical order.

When the first row on a page is requested, the disk page is read into a buffer page. After the page is read in, it does not need not to be read again; requests for subsequent rows on that page are filled from the buffer until all the rows on that page are processed. When one page is exhausted, the page for the next set of rows must be read in.

To make sure that the next page is ready in memory, use the read-ahead configuration parameters described in “How RA_PAGES and RA_THRESHOLD affect table I/O” on page 5-28.

When you use unbuffered devices for dbspaces, and the table is organized properly, the disk pages of consecutive rows are placed in consecutive locations on the disk. This arrangement allows the access arm to move very little when it reads sequentially. In addition, latency costs are usually lower when pages are read sequentially.

Nonsequential access costs

The disk-access time is much higher when a disk device reads table pages nonsequentially than when it reads that same table sequentially.

Whenever a table is read in random order, additional disk accesses are required to read the rows in the required order. Disk costs are higher when the rows of a table are read in a sequence unrelated to physical order on disk. Because the pages are not read sequentially from the disk, both seek and rotational delays occur before each page can be read.

Nonsequential access often occurs when you use an index to locate rows. Although index entries are sequential, there is no guarantee that rows with adjacent index entries must reside on the same (or adjacent) data pages. In many cases, a separate disk access must be made to fetch the page for each row located through an index. If a table is larger than the page buffers, a page that contained a row previously read might be cleaned (removed from the buffer and written back to the disk) before a subsequent request for another row on that page can be processed. That page might have to be read in again.

Depending on the relative ordering of the table with respect to the index, you can sometimes retrieve pages that contain several needed rows. The degree to which the physical ordering of rows on disk corresponds to the order of entries in the index is called *clustering*. A highly clustered table is one in which the physical ordering on disk corresponds closely to the index.

Index lookup costs

The database server incurs additional costs when it finds a row through an index. The index is stored on disk, and its pages must be read into memory with the data pages that contain the desired rows.

An index lookup works down from the root page to a leaf page. The root page, because it is used so often, is almost always found in a page buffer. The odds of finding a leaf page in a buffer depend on the size of the index, the form of the query, and the frequency of column-value duplication. If each value occurs only once in the index and the query is a join, each row to be joined requires a nonsequential lookup into the index, followed by a nonsequential access to the associated row in the table.

Reading duplicate values from an index

Reading an index with duplicate entries incurs an additional cost over reading the table sequentially.

Each entry or set of entries with the same value must be located in the index. Then, for each entry in the index, a random access must be made to the table to read the associated row. However, if there are many duplicate rows per distinct index value, and the associated table is highly clustered, the added cost of joining through the index can be slight.

Searching for NCHAR or NVARCHAR columns in an index

A query using an index on an NCHAR or NVARCHAR scans the entire index, resulting in additional time costs.

Global Language Support (GLS) Only

Indexes that are built on NCHAR or NVARCHAR columns are sorted using a locale-specific comparison value. For example, the Spanish double-l character (ll) might be treated as a single unique character instead of a pair of ls.

In some locales, the comparison value is not based on the code-set order. The index build uses the locale-specific comparison value to store the key values in the index. As a result, a query using an index on an NCHAR or NVARCHAR scans the entire index because the database server searches the index in code-set order.

In-place ALTER TABLE costs

For certain conditions, the database server uses an in-place alter algorithm to modify each row when you execute an ALTER TABLE statement. After the alter table operation, the database server inserts rows using the latest definition. If your query accesses rows that are not yet converted to the new table definition, you might notice a slight degradation in the performance of your individual query, because the database server reformats each row in memory before it is returned.

For more information about the conditions and performance advantages when an in-place alter occurs, see “Altering a table definition” on page 6-32.

View costs

A complex view could run more slowly than expected.

You can create views of tables for a number of reasons:

- To limit the data that a user can access
- To reduce the time that it takes to write a complex query
- To hide the complexity of the query that a user needs to write

However, a query against a view might execute more slowly than expected when the complexity of the view definition causes a temporary table to be created to process the query. This temporary table is referred to as a *materialized view*. For example, you can create a view with a union to combine results from several SELECT statements.

The following sample SQL statement creates a view that includes unions:

```
CREATE VIEW view1 (col1, col2, col3, col4)
AS
    SELECT a, b, c, d
       FROM tab1 WHERE
    UNION
    SELECT a2, b2, c2, d2
       FROM tab2 WHERE
...
    UNION
    SELECT an, bn, cn, dn
       FROM tabn WHERE
;
```

When you create a view that contains complex SELECT statements, the end user does not need to handle the complexity. The end user can just write a simple query, as the following example shows:

```
SELECT a, b, c, d
   FROM view1
  WHERE a < 10;
```

However, this query against **view1** might execute more slowly than expected because the database server creates a fragmented temporary table for the view before it executes the query.

Another situation when the query might execute more slowly than expected is if you use a view in an ANSI join. The complexity of the view definition might cause a temporary table to be created.

To determine if you have a query that must build a temporary table to process the view, execute the SET EXPLAIN statement. If you see Temp Table For View in the SET EXPLAIN output file, your query requires a temporary table to process the view.

Small-table costs

A table is small if it occupies so few pages that it can be retained entirely in the page buffers. Operations on small tables are generally faster than operations on large tables.

As an example, in the **stores_demo** database, the **state** table that relates abbreviations to names of states has a total size of fewer than 1000 bytes; it fits in no more than two pages. This table can be included in any query at little cost. No matter how this table is used, it costs no more than two disk accesses to retrieve this table from disk the first time that it is required.

Data-mismatch costs

An SQL statement can encounter additional costs when the data type of a column that is used in a condition differs from the definition of the column in the CREATE TABLE statement.

For example, the following query contains a condition that compares a column to a data type value that differs from the table definition:

```
CREATE TABLE table1 (a integer, );
SELECT * FROM table1
  WHERE a = '123';
```

The database server rewrites this query before execution to convert 123 to an integer. The SET EXPLAIN output shows the query in its adjusted format. This data conversion has no noticeable overhead.

The additional costs of a data mismatch are most severe when the query compares a character column with a noncharacter value and the length of the number is not equal to the length of the character column. For example, the following query contains a condition in the WHERE clause that equates a character column to an integer value because of missing quotation marks:

```
CREATE TABLE table2 (char_col char(3), );
SELECT * FROM table2
  WHERE char_col = 1;
```

This query finds all of the following values that are valid for **char_col**:

```
' 1'
'001'
'1'
```

These values are not necessarily clustered together in the index keys. Therefore, the index does not provide a fast and correct way to obtain the data. The SET EXPLAIN output shows a sequential scan for this situation.

Warning: The database server does not use an index when the SQL statement compares a character column with a noncharacter value that is not equal in length to the character column.

Encrypted-value costs

An encrypted value uses more storage space than the corresponding plain-text value because all of the information needed to decrypt the value except the encryption key is stored with the value.

Most encrypted data requires approximately 33 percent more storage space than unencrypted data. Omitting the hint used with the password can reduce encryption overhead by up to 50 bytes. If you are using encrypted values, you must make sure that you have sufficient space available for the values.

GLS functionality costs

Sorting or indexing certain data sets can degrade performance.

For information about the performance degradation that occurs from indexing some data sets, see “Searching for NCHAR or NVARCHAR columns in an index” on page 10-25.

If you do not need a non-ASCII collation sequence, use the CHAR and VARCHAR data types for character columns whenever possible. Because CHAR and VARCHAR data require simple value-based comparison, sorting and indexing these columns is less expensive than for non-ASCII data types (NCHAR or NVARCHAR, for example).

For more information about other character data types, see the *IBM Informix GLS User's Guide*.

Network-access costs

Moving data over a network imposes delays in addition to those you encounter with direct disk access.

Network delays can occur when the application sends a query or update request across the network to a database server on another computer. Although the database server performs the query on the remote host computer, that database server returns the output to the application over the network.

Data sent over a network consists of command messages and buffer-sized blocks of row data. Although the details can differ depending on the network and the computers, the database server network activity follows a simple model in which one computer, the *client*, sends a request to another computer, the *server*. The server replies with a block of data from a table.

Whenever data is exchanged over a network, delays are inevitable in the following situations:

- When the network is busy, the client must wait its turn to transmit. Such delays are usually less than a millisecond. However, on a heavily loaded network, these delays can increase exponentially to tenths of seconds and more.

- When the server is handling requests from more than one client, requests might be queued for a time that can range from milliseconds to seconds.
- When the server acts on the request, it incurs the time costs of disk access and in-memory operations that the preceding sections describe.

Transmission of the response is also subject to network delays.

Network access time is extremely variable. In the best case, when neither the network nor the server is busy, transmission and queuing delays are insignificant, and the server sends a row almost as quickly as a local database server might. Furthermore, when the client asks for a second row, the page is likely to be in the page buffers of the server.

Unfortunately, as network load increases, all these factors tend to worsen at the same time. Transmission delays rise in both directions, which increases the queue at the server. The delay between requests decreases the likelihood of a page remaining in the page buffer of the responder. Thus, network-access costs can change suddenly and quite dramatically.

If you use the `SELECT FIRST n` clause in a distributed query, you will still see only the requested amount of data. However, the local database server does not send the `SELECT FIRST n` clause to the remote site. Therefore, the remote site might return more data.

The optimizer that the database server uses assumes that access to a row over the network takes longer than access to a row in a local database. This estimate includes the cost of retrieving the row from disk and transmitting it across the network.

For information about actions that might improve performance across the network, see the following sections:

- “Optimizer estimates of distributed queries” on page 13-28
- “MaxConnect for multiple connections (UNIX)” on page 3-25
- “Multiplexed connections and CPU utilization” on page 3-24
- “Network buffer pools” on page 3-16

Optimization when SQL is within an SPL routine

If an SPL routine contains SQL statements, the database server optimizes and executes the SQL within the SPL routine.

The topics in this section contain information about how and when the database server optimizes and executes these routines.

SQL optimization

If an SPL routine contains SQL statements, at some point the query optimizer evaluates the possible query plans for SQL in the SPL routine and selects the query plan with the lowest cost. The database server puts the selected query plan for each SQL statement in an execution plan for the SPL routine.

When you create an SPL routine with the `CREATE PROCEDURE` statement, the database server attempts to optimize the SQL statements within the SPL routine at that time. If the tables cannot be examined at compile time (because they do not

exist or are not available), the creation does not fail. In this case, the database server optimizes the SQL statements the first time that the SPL routine executes.

The database server stores the optimized execution plan in the **sysprocplan** system catalog table for use by other processes. In addition, the database server stores information about the SPL routine (such as procedure name and owner) in the **sysprocedures** system catalog table and an ASCII version of the SPL routine in the **sysprocbody** system catalog table.

Figure 10-18 summarizes the information that the database server stores in system catalog tables during the compilation process.

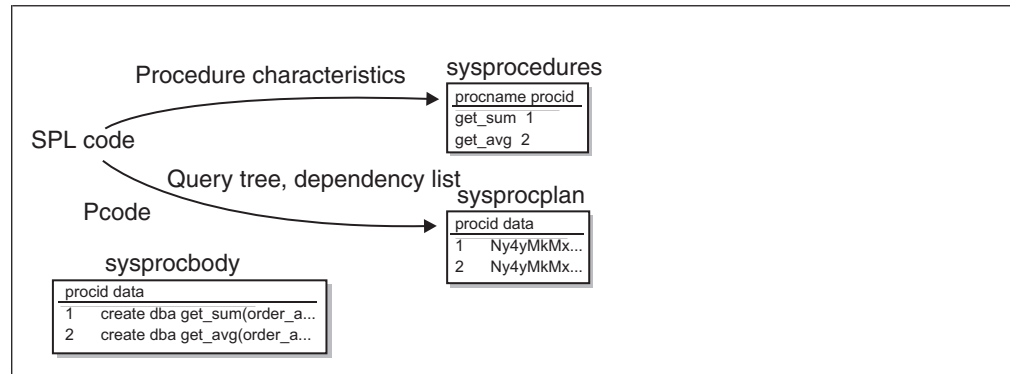

Figure 10-18. SPL information stored in system catalog tables

Displaying the execution plan

When you execute an SPL routine, it is already optimized. You can display the query plan for each SQL statement contained in the SPL routine

To display the query plan, execute the SET EXPLAIN ON statement prior to one of the following SQL statements that always tries to optimize the SPL routine:

- CREATE PROCEDURE
- UPDATE STATISTICS FOR PROCEDURE

For example, use the following statements to display the query plan for an SPL routine:

```
SET EXPLAIN ON;
UPDATE STATISTICS FOR PROCEDURE procname;
```

Automatic reoptimization

In some situations, the database server reoptimizes an SQL statement the next time an SPL routine.

If the AUTO_REPREPARE configuration parameter or the IFX_AUTO_REPREPARE session environment variable is disabled, the following error can result when prepared objects or SPL routines are executed after the schema of a table referenced by the prepared object or indirectly referenced by the SPL routine has been modified:

```
-710 Table <table-name> has been dropped, altered, or renamed.
```

The database server uses a dependency list to keep track of changes that would cause reoptimization the next time that an SPL routine executes.

The database server reoptimizes an SQL statement the next time an SPL routine executes after one of the following situations:

- Execution of any data definition language (DDL) statement (such as ALTER TABLE, DROP INDEX, and CREATE INDEX) that might alter the query plan
- Alteration of a table that is linked to another table with a referential constraint (in either direction)
- Execution of UPDATE STATISTICS FOR TABLE for any table involved in the query
The UPDATE STATISTICS FOR TABLE statement changes the version number of the specified table in **systables**.
- Renaming a column, database, or index with the RENAME statement

Whenever the SPL routine is reoptimized, the database server updates the **sysprocplan** system catalog table with the reoptimized execution plan.

Reoptimizing SPL routines

You can run an SQL statement that reoptimizes an SPL routine to prevent automatic reoptimization.

If you do not want to incur the cost of automatic reoptimization when you first execute an SPL routine after one of the situations that “Automatic reoptimization” on page 10-30 lists, execute the UPDATE STATISTICS statement with the FOR PROCEDURE clause immediately after the situation occurs. In this way, the SPL routine is reoptimized before any users execute it.

To prevent unnecessary reoptimization of all SPL routines, ensure that you specify a specific procedure name in the FOR PROCEDURE clause.

```
UPDATE STATISTICS for procedure myroutine;
```

For guidelines to run UPDATE STATISTICS, see “Update statistics when they are not generated automatically” on page 13-11.

Optimization levels for SQL in SPL routines

The current optimization level set in an SPL routine affects how the SPL routine is optimized.

The algorithm that a SET OPTIMIZATION HIGH statement invokes is a sophisticated, cost-based strategy that examines all reasonable query plans and selects the best overall alternative. For large joins, this algorithm can incur more overhead than desired. In extreme cases, you can run out of memory.

The alternative algorithm that a SET OPTIMIZATION LOW statement invokes eliminates unlikely join strategies during the early stages, which reduces the time and resources spent during optimization. However, when you specify a low level of optimization, the optimal strategy might not be selected because it was eliminated from consideration during early stages of the algorithm.

For SPL routines that remain unchanged or change only slightly and that contain complex SELECT statements, you might want to set the SET OPTIMIZATION statement to HIGH when you create the SPL routine. This optimization level stores the best query plans for the SPL routine. Then set optimization to LOW before you execute the SPL routine. The SPL routine then uses the optimal query plans and runs at the more cost-effective rate if reoptimization occurs.

Execution of an SPL routine

When the database server executes an SPL routine with the EXECUTE PROCEDURE statement, with the CALL statement, or within an SQL statement, the server performs several activities.

The database server performs these activities:

- It reads the interpreter code from the system catalog tables and converts it from a compressed format to an executable format. If the SPL routine is in the UDR cache, the database server retrieves it from the cache and bypasses the conversion step.
- It executes any SPL statements that it encounters.
- When the database server encounters an SQL statement, it retrieves the query plan from the database and executes the statement. If the query plan has not been created, the database server optimizes the SQL statement before it executes.
- When the database server reaches the end of the SPL routine or when it encounters a RETURN statement, it returns any results to the client application. Unless the RETURN statement has a WITH RESUME clause, the SPL routine execution is complete.

SPL routine executable format stored in UDR cache

The first time that a user executes an SPL routine, the database server stores the executable format and any query plans in the UDR cache in the virtual portion of shared memory.

When another user executes an SPL routine, the database server first checks the UDR cache. SPL execution performance improves when the database server can execute the SPL routine from the UDR cache. The UDR cache also stores UDRs, user-defined aggregates, and extended data types definitions.

Related reference

“UDR cache” on page 4-42

Changing the UDR cache

The default number of SPL routines, UDRs, and other user-defined definitions in the UDR cache is 127. You can change the number of entries with the PC_POOLSIZE configuration parameter.

The database server uses a hashing algorithm to store and locate SPL routines in the UDR cache. You can modify the number of *buckets* in the UDR cache with the PC_HASHSIZE configuration parameter. For example, if PC_POOLSIZE is 100 and PC_HASHSIZE is 10, each bucket can have up to 10 SPL routines and UDRs.

Too many buckets cause the database server to move out cached SPL routines when the bucket fills. Too few buckets increase the number of SPL routines in a bucket, and the database server must search through the SPL routines in a bucket to determine if the SPL routine that it needs is there.

When the number of entries in a bucket reaches 75 percent, the database server removes the least recently used SPL routines from the bucket (and hence from the UDR cache) until the number of SPL routines in the bucket is 50 percent of the maximum SPL routines in the bucket.

Important: PC_POOLSIZE and PC_HASHSIZE also control other memory caches for the database server (excluding the buffer pool, the SQL statement cache, the data distribution cache, and the data-dictionary cache). When you modify the size

and number of hash buckets for SPL routines, you also modify the size and number of hash buckets for the other caches (such as the aggregate cache, oplclass, and typename cache).

Related reference

“UDR cache” on page 4-42

Monitoring the UDR cache

You can monitor the UDR cache by running `onstat -g prc`. You can also run `onstat -g cac`, which displays the contents of other memory caches (such as the aggregate cache) as well as the UDR cache.

Figure 10-19 shows sample output for `onstat -g prc`.

```

UDR Cache:
  Number of lists           : 31
  PC_POOLSIZE              : 127
UDR Cache Entries:
list#  id  ref_cnt  dropped?  heap_ptr  udr name
-----
0      138    0        0        a4ba820   sales_rep@london:.destroy
3       50    0        0        a4b2020   sales_rep@london:.assign
6       25    0        0        a4b8420   sales_rep@london:.rowoutput
7       29    0        0        a214860   sales_rep@london:.assign
...

```

Figure 10-19. `onstat -g prc` output

The `onstat -g prc` output has the following fields:

Field	Description
Number of Lists	Number of buckets that PC_HASHSIZE specifies
PC_POOLSIZE	Number of UDRs and SPL routines allowed in the UDR cache
List #	Bucket number
ID	Unique ID of the UDR or SPL routines
Ref count	Number of sessions currently using the UDR or SPL routine from the cache
Dropped	Designation if the SPL routine has been marked to be dropped
Heap ptr	Heap pointer
UDR name	Name of the UDR or SPL routine

Trigger execution

A *trigger* is a database object that automatically executes one or more SQL statements (the *triggered action*) when a specified data manipulation language operation (the *triggering event*) occurs. You can define one or more triggers on a table to execute after a SELECT, INSERT, UPDATE or DELETE triggering event.

You can also define INSTEAD OF triggers on a view. These triggers specify the SQL statements to be executed as triggered actions on the underlying table when a triggering INSERT, UPDATE or DELETE statement attempts to modify the view. These triggers are called INSTEAD OF triggers because only the triggered SQL

action is executed; the triggering event is not executed. For more information about using triggers, see the *IBM Informix Guide to SQL: Tutorial* and information about the CREATE TRIGGER statement in the *IBM Informix Guide to SQL: Syntax*.

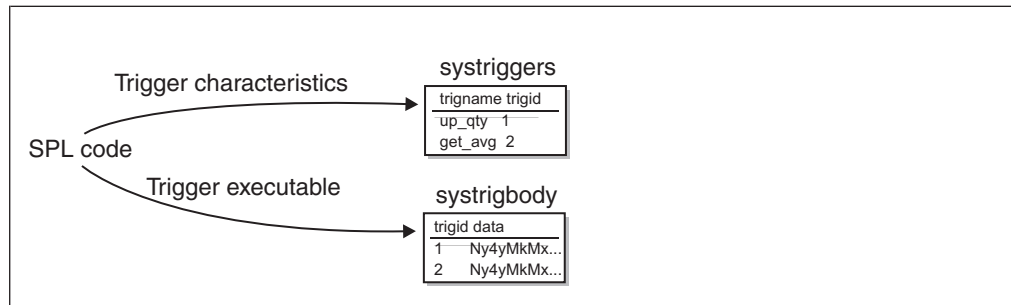

Figure 10-20. Trigger information stored in system catalog tables

When you use the CREATE TRIGGER statement to register a new trigger, the database server:

- Stores information about the trigger in the **systriggers** system catalog table.
- Stores the text of the statements that the trigger executes in the **systrigbody** system catalog table.

The **sysprocedures** system catalog table identifies trigger routines that can be invoked only as triggered actions.

Memory-resident tables of the **sysmaster** database indicate whether the table or view has triggers on it.

Whenever a SELECT, INSERT, UPDATE, or DELETE statement is issued, the database server checks to see if the statement is a *triggering event* that activates a trigger for the table and columns (or for the view) on which the DML statement operates. If the statement requires activating triggers, the database server retrieves the statement text of the triggered actions from the **systrigbody** table and runs the triggered DML statements or SPL routine before, during, or after the triggering events. For INSTEAD OF triggers on a view, the database server performs the triggered actions instead of the triggering events.

Performance implications for triggers

In many situations, triggers can improve performance slightly because of the reduction in the number of messages passed from the client to the database server.

For example, if the trigger fires five SQL statements, the client saves at least 10 messages passed between the client and database server (one to send the SQL statement and one for the reply after the database server executes the SQL statement). Triggers improve performance the most when they execute more SQL statements and the network speed is comparatively slow.

When the database server executes an SQL statement, it must perform the following actions:

- Determine if triggers must be fired
- Retrieve the triggers from **systriggers** and **systrigbody**

These operations cause only a slight performance impact that can be offset by the decreased number of messages passed between the client and the server.

However, triggers executed on SELECT statements have additional performance implications. The following sections explain these implications.

SELECT triggers on tables in a table hierarchy

When the database server executes a SELECT statement that includes a table that is involved in a table hierarchy, and the SELECT statement fires a SELECT trigger, performance might be slower if the SELECT statement that invokes the trigger involves a join, sort, or materialized view.

In this case, the database server does not know which columns are affected in the table hierarchy, so it can execute the query differently. The following behaviors might occur:

- Key-only index scans are disabled on the table that is involved in a table hierarchy.
- If the database server needs to sort data selected from a table involved in a table hierarchy, it copies all of the columns in the SELECT list to the temporary table, not just the sort columns.
- If the database server uses the table included in the table hierarchy to build a hash table for a hash join with another table, it bypasses the early projection, meaning it uses all of the columns from the table to build the hash table, not just the columns in the join.
- If the SELECT statement contains a materialized view (meaning a temporary table must be built for the columns in a view) that contains columns from a table involved in a table hierarchy, all columns from the table are included in the temporary table, not just the columns actually contained in the view.

SELECT triggers and row buffering

The lack of buffering for SELECT statements that fire SELECT triggers might reduce performance slightly compared to an identical SELECT statement that does not fire a SELECT trigger.

In SELECT statements whose tables do not fire SELECT triggers, the database server sends more than one row back to the client and stores the rows in a buffer even though the client application requested only one row with a FETCH statement. However, for SELECT statements that contain one or more tables that fire a SELECT trigger, the database server sends only the requested row back to the client instead of a buffer full. The database server cannot return other rows to the client until the trigger action occurs.

Chapter 11. Optimizer directives

Optimizer directives are comments that tell the query optimizer how to execute a query. You can use optimizer directives to improve query performance.

What optimizer directives are

Optimizer directives are comments that provide information to the query optimizer on how to execute a query.

You can use two kinds of optimizer directives:

- Optimizer directives in the form of instructions that are embedded in queries (For more information, see “Optimizer directives that are embedded in queries.”)
- External optimizer directives that you create and save for use as temporary workaround solutions to problems when you do not want to change SQL statements in queries. (For more information, see “External optimizer directives.”)

Optimizer directives that are embedded in queries

Optimizer directives embedded in queries are comments in a SELECT statement that provide information to the query optimizer on how to execute a query. You can also place directives in UPDATE and DELETE statements, instructing the optimizer how to access the data.

Optimizer directives can either be explicit directions (for example, "use this index" or "access this table first"), or they can eliminate possible query plans (for example, "do not read this table sequentially" or "do not perform a nested-loop join").

External optimizer directives

External optimizer directives are optimizer directives that an administrator can create and store in the **sysdirectives** catalog table. The administrator can then use an ONCONFIG variable to make the directives available.

Client users also specify an environment variable and can choose to use these optimizer directives in queries in situations when they do not want to insert comments in SQL statements.

External directives are useful when it is not feasible to rewrite a query for a short-term solution to a problem, for example, when a query starts to perform poorly. Rewriting the query by changing the SQL statement is preferable for long-term solutions to problems.

External directives are for occasional use only. The number of directives stored in the **sysdirectives** catalog should not exceed 50. A typical enterprise only needs 0 to 9 directives.

Reasons to use optimizer directives

In most cases, the optimizer chooses the fastest query plan. You can use optimizer directives when the optimizer does not choose the best query plan to perform a query, because of the complexity of the query, or because the query does not have enough information about the nature of the data. A poor query plan produces poor performance.

Before you decide when to use optimizer directives, you should understand what makes a good query plan.

The optimizer creates a query plan based on costs of using different table-access paths, join orders, and join plans.

Some query plan guidelines are:

- Do not use an index when the database server must read a large portion of the table. For example, the following query might read most of the **customer** table:

```
SELECT * FROM customer WHERE STATE <> "ALASKA";
```

Assuming the customers are evenly spread among all 50 states, you might estimate that the database server must read 98 percent of the table. It is more efficient to read the table sequentially than to traverse an index (and subsequently the data pages) when the database server must read most of the rows.

- When you choose between indexes to access a table, use an index that can rule out the most rows. For example, consider the following query:

```
SELECT * FROM customer  
WHERE state = "NEW YORK" AND order_date = "01/20/97"
```

Assuming that 200,000 customers live in New York and only 1000 customers ordered on any one day, the optimizer most likely chooses an index on **order_date** rather than an index on **state** to perform the query.

- Place small tables or tables with restrictive filters early in the query plan. For example, consider the following query:

```
SELECT * FROM customer, orders  
WHERE customer.customer_num = orders.customer_num  
AND  
customer.state = "NEVADA";
```

In this example, if you read the **customer** table first, you can rule out most of the rows by applying the filter that chooses all rows in which state = "NEVADA".

By ruling out rows in the **customer** table, the database server does not read as many rows in the **orders** table (which might be significantly larger than the **customer** table).

- Choose a hash join when neither column in the join filter has an index.

In the previous example, if **customer.customer_num** and **orders.customer_num** are not indexed, a hash join is probably the best join plan.

- Choose nested-loop joins if:
 - The number of rows retrieved from the outer table after the database server applies any table filters is small, and the inner table has an index that can be used to perform the join.
 - The index on the outermost table can be used to return rows in the order of the ORDER BY clause, eliminating the need for a sort.

For information about query plans, see "The query plan" on page 10-1. For more information about directives, see

- “Preparation for using directives”
- “Guidelines for using directives”
- “Types of directives that are included in SQL statements”

Preparation for using directives

In most cases, the optimizer chooses the fastest query plan. However, you can take steps to assist the optimizer and to prepare for using directives.

To prepare for using directives, make sure that you perform the following tasks:

- Run UPDATE STATISTICS.

Without accurate statistics, the optimizer cannot choose the appropriate query plan. Run UPDATE STATISTICS any time that the data in the tables changes significantly (many new rows are added, updated, or deleted). For more information, see “Updating the number of rows” on page 13-12.

- Create distributions.

One of the first things that you should try when you attempt to improve a slow query is to create distributions on columns involved in a query. Distributions provide the most accurate information to the optimizer about the nature of the data in the table. Run UPDATE STATISTICS HIGH on columns involved in the query filters to see if performance improves. For more information, see “Creating data distributions” on page 13-13.

In some cases, the query optimizer does not choose the best query plan because of the complexity of the query or because (even with distributions) it does not have enough information about the nature of the data. In these cases, you can attempt to improve performance for a particular query by using directives.

Guidelines for using directives

Guidelines for directives include frequently analyzing the effectiveness of the query and using negative directives.

Consider the following guidelines:

- Examine the effectiveness of a particular directive frequently to make sure it continues to operate effectively. Imagine a query in a production program with several directives that force an optimal query plan. Some days later, users add, update, or delete a large number of rows, which changes the nature of the data so much that the once optimal query plan is no longer effective. This example illustrates how you must use directives with care.
- Use negative directives (such as AVOID_NL, AVOID_FULL, and so on) whenever possible. When you exclude a behavior that degrades performance, you rely on the optimizer to use the next-best choice rather than attempt to force a path that might not be optimal.

Types of directives that are included in SQL statements

Directives that are in SQL statements are embedded in queries. These directives include access-method directives, join-order directives, join-plan directives, and optimization-goal directives.

Include the directives in the SQL statement as a comment that occurs immediately after the SELECT, UPDATE, or DELETE keyword. The first character in a directive is always a plus (+) sign. In the following query, the ORDERED directive specifies

that the tables should be joined in the same order as they are listed in the FROM clause. The AVOID_FULL directive specifies that the optimizer should discard any plans that include a full table scan on the listed table (**employee**).

```
SELECT --+ORDERED, AVOID_FULL(e) * FROM employee e, department d
> 50000;
```

For a complete syntax description for directives, see the *IBM Informix Guide to SQL: Syntax*.

To influence the choice of a query plan that the optimizer makes, you can alter the following aspects of a query:

- Access method
- Join order
- Join plan
- Optimization goal

You can also use EXPLAIN directives instead of the SET EXPLAIN statement to show the query plan. The following sections describe these aspects in detail.

Access-method directives

The database server uses an access method to access a table. The server can either read the table sequentially via a full table scan or use any one of the indexes on the table. Access-method directives influence the access method.

The following table lists the directives that influence the access method:

Access-Method Directive	Description
INDEX	Tells the optimizer to use the index specified to access the table. If the directive lists more than one index, the optimizer chooses the index that yields the least cost.
AVOID_INDEX	Tells the optimizer not use any of the indexes listed. You can use this directive with the AVOID_FULL directive.
INDEX_SJ	Forces an index self-join path using the specified index, or choosing the least costly index in a list of indexes, even if data distribution statistics are not available for the leading index key columns of the index. For information about index self-join paths, see “Query plans that include an index self-join path” on page 10-7.
AVOID_INDEX_SJ	Tells the optimizer not to use an index self-join path for the specified index or indexes.
FULL	Tells the optimizer to perform a full table scan.
AVOID_FULL	Tells the optimizer not to perform a full table scan on the listed table. You can use this directive with the AVOID_INDEX directive.

In some cases, forcing an access method can change the join method that the optimizer chooses. For example, if you exclude the use of an index with the `AVOID_INDEX` directive, the optimizer might choose a hash join instead of a nested-loop join.

The optimizer will consider an index self-join path only if all of the following conditions are met:

- The index does not have functional keys, user-defined types, built-in opaque types, or non-B-tree indexes
- Data distribution statistics are available for the index key column under consideration
- The number of rows in the table is at least ten times the number of unique combinations of all possible lead-key column values.

If all of these conditions are met, the optimizer estimates the cost of an index self-join path and compares it with the costs of alternative access methods. The optimizer then picks the best access method for the table. For more information about the `INDEX_SJ` and `AVOID_INDEX_SJ` directives and some examples of `INDEX_SJ` usage, see the *IBM Informix Guide to SQL: Syntax*.

Join-order directives

The join-order directive `ORDERED` forces the optimizer to join tables in the order that the `SELECT` statement lists them.

Effect of join order on join plan

By specifying the join order, you might affect more than just how tables are joined.

For example, consider the following query:

```
SELECT --+ORDERED, AVOID_FULL(e)
* FROM employee e, department d
WHERE e.dept_no = d.dept_no AND e.salary > 5000
```

In this example, the optimizer chooses to join the tables with a hash join. However, if you arrange the order so that the second table is **employee** (and must be accessed by an index), the hash join is not feasible.

```
SELECT --+ORDERED, AVOID_FULL(e)
* FROM department d, employee e
WHERE e.dept_no = d.dept_no AND e.salary > 5000;
```

The optimizer chooses a nested-loop join in this case.

Join order when you use views

The `ORDERED` directive that is inside a view or is in a query that contains a view affect the join order.

Two cases can affect join order when you use views:

- The `ORDERED` directive is inside the view.

The `ORDERED` directive inside a view affects the join order of only the tables inside the view. The tables in the view must be joined contiguously. Consider the following view and query:

```
CREATE VIEW emp_job_view as
  SELECT {+ORDERED}
    emp.job_num, job.job_name
  FROM emp, job
  WHERE emp.job_num = job.job_num;
```

```
SELECT * from dept, emp_job_view, project
  WHERE dept.dept_no = project.dept_num
  AND emp_job_view.job_num = project.job_num;
```

The ORDERED directive specifies that the **emp** table come before the job table. The directive does not affect the order of the **dept** and **project** table. Therefore, all possible join orders are as follows:

- **emp, job, dept, project**
- **emp, job, project, dept**
- **project, emp, job, dept**
- **dept, emp, job, project**
- **dept, project, emp, job**
- **project, dept, emp, job**

- The ORDERED directive is in a query that contains a view.

If an ORDERED directive appears in a query that contains a view, the join order of the tables in the query are the same as they are listed in the SELECT statement. The tables within the view are joined as they are listed within the view.

In the following query, the join order is **dept, project, emp, job**:

```
CREATE VIEW emp_job_view AS
  SELECT
    emp.job_num, job.job_name
  FROM emp, job
  WHERE emp.job_num = job.job_num;
SELECT {+ORDERED}
  * FROM dept, project, emp_job_view
  WHERE dept.dept_no = project.dept_num
  AND emp_job_view.job_num = project.job_num;
```

An exception to this rule is when the view cannot be folded into the query, as in the following example:

```
CREATE VIEW emp_job_view2 AS
  SELECT DISTINCT
    emp.job_num, job.job_name
  FROM emp, job
  WHERE emp.job_num = job.job_num;
```

In this example, the database server executes the query and puts the result in a temporary table. The order of tables in this query is **dept, project, temp_table**.

Join-plan directives

The join-plan directives influence how the database server joins two tables in a query.

The following directives influence the join plan between two tables:

- USE_NL

Use the listed tables as the inner table in a nested-loop join.

- USE_HASH

Access the listed tables with a hash join. You can also choose whether the table is used to create the hash table or to probe the hash table.

- AVOID_NL

Do not use the listed tables as the inner table in a nested-loop join. A table listed with this directive can still participate in a nested-loop join as an outer table.

- AVOID_HASH

Do not access the listed tables with a hash join. Optionally, you can allow a hash join but restrict the table from being the one that is probed or the table from which the hash table is built.

Optimization-goal directives

In some queries, you might want to find only the first few rows in the result of a query. Or, you might know that all rows must be accessed and returned from the query. You can use the optimization-goal directives to find the first row that satisfies the query or all rows that satisfy the query.

For example, you might want to find only the first few rows in the result of a query, because an Informix ESQL/C program opens a cursor for the query and performs a FETCH to find only the first row.

Use the optimization-goal directives to optimize the query for either one of these cases:

- **FIRST_ROWS**
Choose a plan that optimizes the process of finding only the first row that satisfies the query.
- **ALL_ROWS**
Choose a plan that optimizes the process of finding all rows (the default behavior) that satisfy the query.

If you use the **FIRST_ROWS** directive, the optimizer might abandon a query plan that contains activities that are time-consuming up front. For example, a hash join might take too much time to create the hash table. If only a few rows must be returned, the optimizer might choose a nested-loop join instead.

In the following example, assume that the database has an index on **employee.dept_no** but not on **department.dept_no**. Without directives, the optimizer chooses a hash join.

```
SELECT *  
FROM employee, department  
WHERE employee.dept_no = department.dept_no
```

However, with the **FIRST_ROWS** directive, the optimizer chooses a nested-loop join because of the high initial overhead required to create the hash table.

```
SELECT {+first_rows} *  
FROM employee, department  
WHERE employee.dept_no = department.dept_no
```

Example of directives that can alter a query plan

Directives can alter the query plan. You can use particular directives to force the optimizer to choose a particular type of query plan, for example one that uses hash joins and the order of tables as they appear in the query.

The following example shows how directives can alter the query plan.

Suppose you have the following query:

```
SELECT * FROM emp,job,dept  
WHERE emp.location = 10  
      AND emp.jobno = job.jobno  
      AND emp.deptno = dept.deptno  
      AND dept.location = "DENVER";
```

Assume that the following indexes exist:

```
ix1: emp(empno,jobno,deptno,location)
ix2: job(jobno)
ix3: dept(location)
```

You run the query with SET EXPLAIN ON to display the query path that the optimizer uses.

QUERY:

```
-----
SELECT * FROM emp,job,dept
WHERE emp.location = "DENVER"
      AND emp.jobno = job.jobno
      AND emp.deptno = dept.deptno
      AND dept.location = "DENVER"
```

```
Estimated Cost: 5
Estimated # of Rows Returned: 1
```

1) informix.emp: INDEX PATH

Filters: informix.emp.location = 'DENVER'

(1) Index Keys: empno jobno deptno location (Key-Only)

2) informix.dept: INDEX PATH

Filters: informix.dept.deptno = informix.emp.deptno

(1) Index Keys: location

Lower Index Filter: informix.dept.location = 'DENVER'

NESTED LOOP JOIN

3) informix.job: INDEX PATH

(1) Index Keys: jobno (Key-Only)

Lower Index Filter: informix.job.jobno = informix.emp.jobno

NESTED LOOP JOIN

The diagram in Figure 11-1 shows a possible query plan for this query. The query plan has three levels of information: (1) a nested-loop join, (2) an index scan on one table and a nested-loop join, and (3) index scans on two other tables.

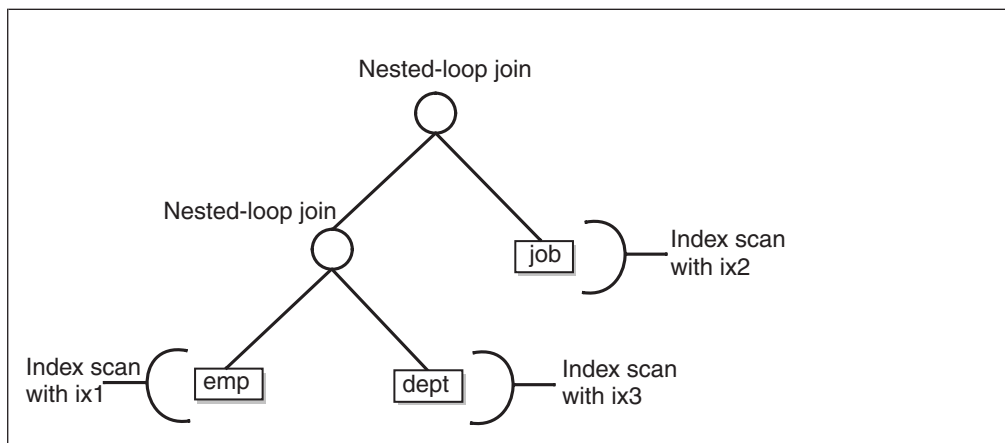

Figure 11-1. Possible query plan without directives

Perhaps you are concerned that using a nested-loop join might not be the fastest method to execute this query. You also think that the join order is not optimal. You can force the optimizer to choose a hash join and order the tables in the query plan

according to their order in the query, so the optimizer uses the query plan that Figure 11-2 shows. This query plan that has three levels of information: (1) a hash join, (2) an index scan and a hash join, and (3) an index scan on two other tables.

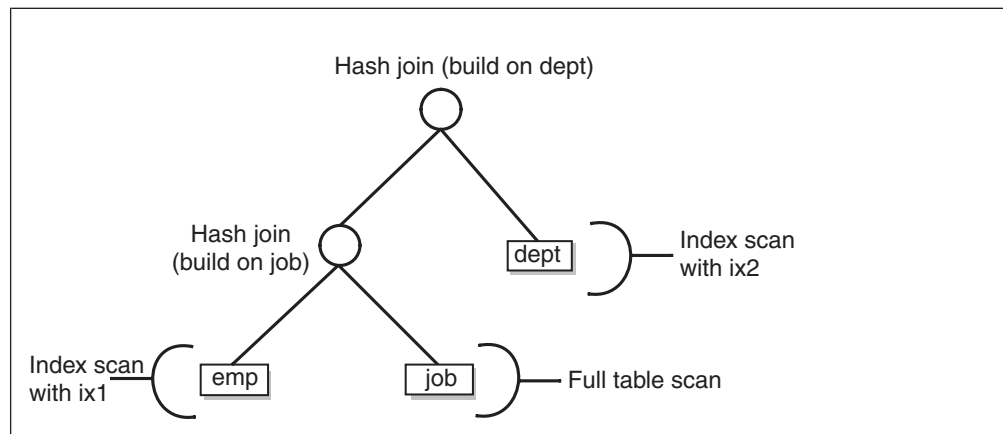

Figure 11-2. Possible query plan with directives

To force the optimizer to choose the query plan that uses hash joins and the order of tables shown in the query, use the directives that the following partial SET EXPLAIN output shows:

```

QUERY:
-----
SELECT {+ORDERED,
        INDEX(emp ix1),
        FULL(job),
        USE_HASH(job /BUILD),
        USE_HASH(dept /BUILD),
        INDEX(dept ix3)}
* FROM emp,job,dept
WHERE emp.location = 1
AND emp.jobno = job.jobno
AND emp.deptno = dept.deptno
AND dept.location = "DENVER"

```

```

DIRECTIVES FOLLOWED:
ORDERED
INDEX ( emp ix1 )
FULL ( job )
USE_HASH ( job/BUILD )
USE_HASH ( dept/BUILD )
INDEX ( dept ix3 )
DIRECTIVES NOT FOLLOWED:

```

```

Estimated Cost: 7
Estimated # of Rows Returned: 1

```

- 1) informix.emp: INDEX PATH
 - Filters: informix.emp.location = 'DENVER'
 - (1) Index Keys: empno jobno deptno location (Key-Only)
- 2) informix.job: SEQUENTIAL SCAN

```

DYNAMIC HASH JOIN
Dynamic Hash Filters: informix.emp.jobno = informix.job.jobno

```



```

3) informix.dept: INDEX PATH
    (1) Index Keys: location
        Lower Index Filter: informix.dept.location = 'DENVER'

DYNAMIC HASH JOIN
    Dynamic Hash Filters: informix.emp.deptno = informix.dept.deptno

```

EXPLAIN directives

You can use the EXPLAIN directives to display the query plan that the optimizer chooses, and you can specify to display the query plan without running the query.

You can use these directives:

- EXPLAIN
Displays the query plan that the optimizer chooses.
- EXPLAIN AVOID_EXECUTE
Displays the query plan that the optimizer chooses, but does not run the query.

When you want to display the query plan for one SQL statement only, use these EXPLAIN directives instead of the SET EXPLAIN ON or SET EXPLAIN ON AVOID_EXECUTE statements.

When you use AVOID_EXECUTE (either the directive or in the SET EXPLAIN statement), the query does not execute but displays the following message:

No rows returned.

Figure 11-3 shows sample output for a query that uses the EXPLAIN AVOID_EXECUTE directive.

```

QUERY:
-----
select --+ explain avoid_execute
  l.customer_num, l.lname, l.company,
  l.phone, r.call_dtime, r.call_descr
from customer l, cust_calls r
where l.customer_num = r.customer_num

DIRECTIVES FOLLOWED:
EXPLAIN
AVOID_EXECUTE
DIRECTIVES NOT FOLLOWED:

Estimated Cost: 7
Estimated # of Rows Returned: 7

1) informix.r: SEQUENTIAL SCAN

2) informix.l: INDEX PATH

    (1) Index Keys: customer_num (Serial, fragments: ALL)
        Lower Index Filter: informix.l.customer_num = informix.r.customer_num
NESTED LOOP JOIN

```

Figure 11-3. Result of EXPLAIN AVOID_EXECUTE directives

The following table describes the pertinent output lines in Figure 11-3 that describe the chosen query plan.

Output Line in Figure 11-3 on page 11-10	Chosen Query Plan Description
DIRECTIVES FOLLOWED: EXPLAIN AVOID_EXECUTE	Use the directives EXPLAIN and AVOID_EXECUTE to display the query plan and do not execute the query.
Estimated # of Rows Returned: 7	Estimate that this query returns seven rows.
Estimated Cost: 7	This estimated cost of 7 is a value that the optimizer uses to compare different query plans and select the one with the lowest cost.
1) informix.r: SEQUENTIAL SCAN	Use the cust_calls r table as the outer table and scan it to obtain each row.
2) informix.l: INDEX PATH	For each row in the outer table, use an index to obtain the matching row(s) in the inner table customer l .
(1) Index Keys: customer_num (Serial, fragments: ALL)	Use the index on the customer_num column, scan it serially, and scan all fragments (the customer l table consists of only one fragment).
Lower Index Filter: informix.l.customer_num = informix.r.customer_num	Start the index scan at the customer_num value from the outer table.

Configuration parameters and environment variables for optimizer directives

You can use the **DIRECTIVES** configuration parameter to turn on or off all directives that the database server encounters, and you can use the **IFX_DIRECTIVES** environment variable to override the setting of the **DIRECTIVES** configuration parameter.

If the **DIRECTIVES** configuration parameter is set to 1 (the default), the optimizer follows all directives. If the **DIRECTIVES** configuration parameter is set to 0, the optimizer ignores all directives.

You can override the setting of **DIRECTIVES**. If the **IFX_DIRECTIVES** environment variable is set to 1 or ON, the optimizer follows directives for any SQL the client session executes. If **IFX_DIRECTIVES** is 0 or OFF, the optimizer ignores directives for any SQL in the client session.

Any directives in an SQL statement take precedence over the join plan that the **OPTCOMPIND** configuration parameter forces. For example, if a query includes the **USE_HASH** directive and **OPTCOMPIND** is set to 0 (nested-loop joins preferred over hash joins), the optimizer uses a hash join.

Optimizer directives and SPL routines

Directives operate differently for a query in an SPL routine because a **SELECT** statement in an SPL routine is not necessarily optimized immediately before the database server executes it.

The optimizer creates a query plan for a SELECT statement in an SPL routine when the database server creates an SPL routine or during the execution of some versions of the UPDATE STATISTICS statement.

The optimizer reads and applies directives at the time that it creates the query plan. Because it stores the query plan in a system catalog table, the SELECT statement is not reoptimized when it is executed. Therefore, settings of **IFX_DIRECTIVES** and **DIRECTIVES** affect SELECT statements inside an SPL routine when they are set at any of the following times:

- Before the CREATE PROCEDURE statement
- Before the UPDATE STATISTICS statements that cause SQL in SPL to be optimized
- During certain circumstances when SELECT statements have variables supplied at runtime

Forcing reoptimization to avoid an index and previously prepared statement problem

If the **AUTO_REPREPARE** configuration parameter and the **IFX_AUTO_REPREPARE** session environment variable are enabled, Informix automatically recompiles prepared statements and SPL routines after the schema of a referenced table is modified by a DDL statement. If the **AUTO_REPREPARE** configuration parameter or the **IFX_AUTO_REPREPARE** session environment variable is disabled, you can take steps to prevent errors.

If the **AUTO_REPREPARE** configuration parameter or the **IFX_AUTO_REPREPARE** session environment variable is disabled, the following error can result when prepared objects or SPL routines are executed after the schema of a table referenced by the prepared object or indirectly referenced by the SPL routine has been modified.

-710 Table <table-name> has been dropped, altered, or renamed.

This error can occur with explicitly prepared statements. These statements have the following form:

```
PREPARE statement id FROM quoted string
```

After a statement has been prepared in the database server and before execution of the statement, a table to which the statement refers might have been renamed or altered, possibly changing the structure of the table. Problems can occur as a result.

Adding an index to the table after preparing the statement can also invalidate the statement. A subsequent OPEN command for a cursor fails if the cursor refers to the invalid prepared statement; the failure occurs even if the OPEN command has the WITH REOPTIMIZATION clause.

If an index was added after the statement was prepared, you must prepare the statement again and declare the cursor again. You cannot simply reopen the cursor if it was based on a prepared statement that is no longer valid.

This error can also occur with SPL routines. Before the database server executes a new SPL routine the first time, it optimizes the code (statements) in the SPL routine. Optimization makes the code depend on the structure of the tables that the procedure references. If the table structure changes after the procedure is optimized, but before it is executed, this error can occur.

Each SPL routine is optimized the first time that it is run (not when it is created). This behavior means that an SPL routine might succeed the first time it is run but fail later under virtually identical circumstances. The failure of an SPL routine can also be intermittent, because failure during one execution forces an internal warning to reoptimize the procedure before the next execution.

The database server keeps a list of tables that the SPL routine references explicitly. Whenever any one of these explicitly referenced tables is modified, the database server reoptimizes the procedure the next time the procedure is executed.

However, if the SPL routine depends on a table that is referenced only indirectly, the database server cannot detect the need to reoptimize the procedure after that table is changed. For example, a table can be referenced indirectly if the SPL routine invokes a trigger. If a table that is referenced by the trigger (but not directly by the SPL routine) is changed, the database server does not know that it should reoptimize the SPL routine before running it. When the procedure is run after the table has been changed, this error can occur.

Use one of two methods to recover from this error:

- Issue the UPDATE STATISTICS statement to force reoptimization of the procedure.
- Rerun the procedure.

To prevent this error, you can force reoptimization of the SPL routine. To force reoptimization, execute the following statement:

```
UPDATE STATISTICS FOR PROCEDURE procedure name
```

You can add this statement to your program in either of the following ways:

- Place the UPDATE STATISTICS statement after each statement that changes the mode of an object.
- Place the UPDATE STATISTICS statement before each execution of the SPL routine.

For efficiency, you can put the UPDATE STATISTICS statement with the action that occurs less frequently in the program (change of object mode or execution of the procedure). In most cases, the action that occurs less frequently in the program is the change of object mode.

When you follow this method of recovering from this error, you must execute the UPDATE STATISTICS statement for each procedure that references the changed tables indirectly unless the procedure also references the tables explicitly.

You can also recover from this error by simply rerunning the SPL routine. The first time that the stored procedure fails, the database server marks the procedure as needing reoptimization. The next time that you run the procedure, the database server reoptimizes the procedure before running it. However, running the SPL routine twice might not be practical or safe. A safer choice is to use the UPDATE STATISTICS statement to force reoptimization of the procedure.

External optimizer directives

If you are user **informix**, you can create, save, and delete external directives.

Creating and saving external directives

You can define external directives by creating *association records* that include query optimizer directives, and saving those records in the **sysdirectives** system catalog table. Association records associate a list of one or more optimizer directives with a specific query text. The database server can apply those optimizer directives to subsequent instances of the same query text.

To create and save external directives:

Use the SAVE EXTERNAL DIRECTIVES statement to create the association record to use for the list of one or more query directives.

The following example shows a SAVE EXTERNAL TABLE statement that registers an association-record in the system catalog as a new row in the **sysdirectives** table that can be used as a query optimizer directive.

```
SAVE EXTERNAL DIRECTIVES {+INDEX(t1,i11)} ACTIVE FOR
  SELECT {+INDEX(t1, i2) } c1 FROM t1 WHERE c1=1;
```

The following data is stored in the association record that the SQL statement above defined:

```
id          16
query       select {+INDEX(t1, i2) } c1 from t1 where c1=1
directive   INDEX(t1,i11)
directivecode BYTE value
active      1
hashcode    -589336273
```

Here {+INDEX(t1,i11)}, the external directive that followed the DIRECTIVES keyword, will be applied to future instances of the specified query, but the inline {+INDEX(t1,i2)} directive will be ignored.

The information in the external directives that immediately follow the DIRECTIVES keyword must be within comment indicators, just as the same directives would appear in SELECT, UPDATE, MERGE, and DELETE statements, except that blank characters, rather than comma (,) symbols, are the required separators if the list of external directives includes more than one directive.

See the *IBM Informix Guide to SQL: Syntax* for more information on the SAVE EXTERNAL DIRECTIVES statement.

Enabling external directives

After you create and save external directives, you must set the configuration parameter and environmental variable that enable the directives. The database server only searches for a directive for a query if the external directives are set on both the database server and the client.

Enable the directive using a combination of the EXT_DIRECTIVES configuration parameter, which is in the ONCONFIG file, and the **IFX_EXTDIRECTIVES** client-side environment variable.

The EXT_DIRECTIVE values that you can use are:

Value	Explanation
0 (default)	Off. The directive cannot be enabled, even if IFX_EXTDIRECTIVES is enabled.

Value	Explanation
1	On. The directive can be enabled for a session if IFX_EXTDIRECTIVES is enabled.
2	On. The directive can be used even if IFX_EXTDIRECTIVES is not enabled.

You can also use the EXTDIRECTIVES option of the SET ENVIRONMENT statement to enable or disable external directives during a session. What you specify using the EXTDIRECTIVES option overwrites the external directive setting that is specified in the EXT_DIRECTIVES configuration parameter in the ONCONFIG file.

To overwrite the value for enabling or disabling the external directive in the ONCONFIG file:

- To enable the external directives during a session, specify 1, on, or ON as the value for SET ENVIRONMENT EXTDIRECTIVES.
- To disable the external directives during a session, specify 0, off, or OFF as the value for SET ENVIRONMENT EXTDIRECTIVES.

To enable the default values specified in the EXT_DIRECTIVES configuration parameter and in the client-side IFX_EXTDIRECTIVES environment variable during a session, specify DEFAULT as the value for the EXTDIRECTIVES option of the SET ENVIRONMENT statement.

The **sqexplain.out file**, which is described in “The sqexplain.out file” on page 10-10, tells you if external directives are in effect.

Deleting external directives

When you no longer need an external directive, the DBA or user **informix** can use the DELETE statement of SQL to remove it from the **sysdirectives** system catalog table.

When external directives are enabled and the **sysdirectives** system catalog table is not empty,

- the database server compares every query with the query text of every ACTIVE external directive,
- and for queries executed by the DBA (or by user **informix**) with every TEST ONLY external directive.

The purpose of external directives is to improve the performance of queries that match the query string, but the use of such directives can potentially slow other queries, if the query execution optimizer must compare the query strings of a large number of active external directives with the text of every SELECT statement. For this reason, IBM recommends that the DBA not allow the **sysdirectives** table to accumulate more than a few ACTIVE rows. (An alternative way to avoid unintended performance impact on other queries is to disable support for external directives by setting the EXT_DIRECTIVES configuration parameter to 0. Setting the **IFX_EXTDIRECTIVES** client environment variable to 0 has the same effect.)

Chapter 12. Parallel database query (PDQ)

You can manage how the database server performs PDQ and you can monitor the resources that the database server uses for PDQ.

What PDQ is

Parallel database query (PDQ) is a database server feature that can improve performance dramatically when the server processes queries that decision-support applications initiate. PDQ enables Informix to distribute the work for one aspect of a query among several processors. For example, if a query requires an aggregation, Informix can distribute the work for the aggregation among several processors.

PDQ also includes tools for resource management.

Another database server feature, *table fragmentation*, allows you to store the parts of a table on different disks. PDQ delivers maximum performance benefits when the data that you query is in fragmented tables. For information about how to use fragmentation for maximum performance, see “Planning a fragmentation strategy” on page 9-1.

Structure of a PDQ query

Each decision-support query has a primary thread. The database server can start additional threads to perform tasks for the query (for example, scans and sorts). Depending on the number of tables or fragments that a query must search and the resources that are available for a decision-support query, the database server assigns different components of a query to different threads.

The database server initiates these PDQ threads, which are listed as *secondary threads* in the SET EXPLAIN output.

Secondary threads are further classified as either *producers* or *consumers*, depending on their function. A producer thread supplies data to another thread. For example, a scan thread might read data from shared memory that corresponds to a given table and pass it along to a join thread. In this case, the scan thread is considered a producer, and the join thread is considered a consumer. The join thread, in turn, might pass data along to a sort thread. When doing so, the join thread is considered a producer, and the sort thread is considered a consumer.

Several producers can supply data to a single consumer. When this situation occurs, the database server sets up an internal mechanism, called an *exchange*, that synchronizes the transfer of data from those producers to the consumer. For instance, if a fragmented table is to be sorted, the optimizer typically calls for a separate scan thread for each fragment. Because of different I/O characteristics, the scan threads can be expected to complete at different times. An exchange is used to funnel the data produced by the various scan threads into one or more sort threads with a minimum of buffering. Depending on the complexity of the query, the optimizer might call for a multilayered hierarchy of producers, exchanges, and consumers. Generally speaking, consumer threads work in parallel with producer threads so that the amount of intermediate buffering that the exchanges perform remains negligible.

The database server creates these threads and exchanges automatically and transparently. They terminate automatically as they complete processing for a given query. The database server creates new threads and exchanges as needed for subsequent queries.

Database server operations that use PDQ

Informix processes some types of SQL operations that the database server processes in parallel. However some situations limit the degree of parallelism that Informix can use.

In the topics on database server operations that use PDQ in this section, a *query* is any SELECT statement.

Parallel delete operations

Informix performs some types of delete operations in parallel.

The database server takes the following two steps to process DELETE, INSERT, and UPDATE statements:

1. Fetches the qualifying rows
2. Applies the action of deleting, inserting, or updating

The database server performs the first step of a DELETE statement in parallel, with one exception; the database server does not process the first part of a DELETE statement in parallel if the targeted table has a referential constraint that can cascade to a child table.

Parallel insert operations

Informix performs some types of insert operations in parallel.

The types of insert operations that the server performs in parallel are:

- SELECT...INTO TEMP inserts using explicit temporary tables.
- INSERT INTO...SELECT inserts using implicit temporary tables.

Explicit inserts with SELECT...INTO TEMP statements

The database server can insert rows in parallel into explicit temporary tables that you specify in SQL statements of the form SELECT...INTO TEMP.

For example, the database server can perform the inserts in parallel into the temporary table, **temp_table**, as the following example shows:

```
SELECT * FROM table1 INTO TEMP temp_table
```

To perform parallel inserts into a temporary table:

1. Set PDQ priority > 0.

You must meet this requirement for any query that you want the database server to perform in parallel.

2. Set DBSPACETEMP to a list of two or more dbspaces.

This step is required because of the way that the database server performs the insert. To perform the insert in parallel, the database server first creates a fragmented temporary table. So that the database server knows where to store the fragments of the temporary table, you must specify a list of two or more dbspaces in the DBSPACETEMP configuration parameter or the

DBSPACETEMP environment variable. In addition, you must set **DBSPACETEMP** to indicate storage space for the fragments before you execute the **SELECT...INTO** statement.

The database server performs the parallel insert by writing in parallel to each of the fragments in a round-robin fashion. Performance improves as you increase the number of fragments.

Implicit inserts with INSERT INTO...SELECT statements

The database server can also insert rows in parallel into implicit tables that it creates when it processes SQL statements of the form **INSERT INTO...SELECT**.

For example, the database server processes the following **INSERT** statement in parallel:

```
INSERT INTO target_table SELECT * FROM source_table
```

The target table can be either a permanent table or a temporary table.

The database server processes this type of **INSERT** statement in parallel only when the target tables meet the following criteria:

- The value of PDQ priority is greater than 0.
- The target table is fragmented into two or more dbspaces.
- The target table has no enabled referential constraints or triggers.
- The target table is not a remote table.
- In a database with logging, the target table does not contain filtering constraints.
- The target table does not contain columns of TEXT or BYTE data type.

The database server does not process parallel inserts that reference an SPL routine. For example, the database server never processes the following statement in parallel:

```
INSERT INTO table1 EXECUTE PROCEDURE ins_proc
```

Parallel index builds

Index builds can take advantage of PDQ and can be parallelized. The database server performs both scans and sorts in parallel for index builds.

The following operations initiate index builds:

- Create an index.
- Add a unique, primary key.
- Add a referential constraint.
- Enable a referential constraint.

When PDQ is in effect, the scans for index builds are controlled by the PDQ configuration parameters described in “The allocation of resources for parallel database queries” on page 12-7.

If you have a computer with multiple CPUs, the database server uses two sort threads to sort the index keys. The database server uses two sort threads during index builds without the user setting the **PSORT_NPROCS** environment variable.

Parallel user-defined routines

If a query contains a user-defined routine (UDR) in an expression, the database server can execute a query in parallel when you turn on PDQ.

The database server can perform the following parallel operations if the UDR is written and registered appropriately:

- Parallel scans
- Parallel comparisons with the UDR

For more information about how to enable parallel execution of UDRs, see “Parallel UDRs” on page 13-37.

Hold cursors that use PDQ

When hold cursors that are created by declaring the WITH HOLD qualifier have no locks, PDQ is enabled.

PDQ will be set for hold cursors in the following cases:

- Queries with Dirty Read or Committed Read isolation level, ANSI, and read-only cursor
- Queries with Dirty Read or Committed Read isolation level, NON-ANSI, non-updateable cursor

SQL operations that do not use PDQ

The database server does not process some types of queries in parallel.

For example, the server does not process the following types of queries in parallel:

- Queries started with an isolation level of Cursor Stability
Subsequent changes to the isolation level do not affect the parallelism of queries already prepared. This situation results from the inherent nature of parallel scans, which scan several rows simultaneously.
- Queries that use a cursor declared as FOR UPDATE
- An UPDATE statement that has an *update* trigger that updates in the For Each Row section of the trigger definition
- Data definition language (DDL) statements

For a complete list, see the *IBM Informix Guide to SQL: Syntax*.

In addition, the database server does not process sequences in PDQ operations. If your SQL statement includes sequencing operations, PDQ functions will be disabled for that statement.

Update statistics operations affected by PDQ

An SQL UPDATE STATISTICS statement that is not processed in parallel, is affected by PDQ because it must allocate the memory used for sorting. Thus the behavior of the UPDATE STATISTICS statement is affected by the memory management associated with PDQ.

The database server must allocate the memory that the UPDATE STATISTICS statement uses for sorting.

If you have an extremely large database and indexes are fragmented, UPDATE STATISTICS LOW can automatically run statements in parallel. For more information, see “Updating statistics on very large databases” on page 13-17.

SPL routines and triggers and PDQ

Statements that involve SPL routines are not executed in parallel. However, statements within procedures are executed in parallel.

When the database server executes an SPL routine, it does not use PDQ to process non-related SQL statements contained in the procedure. However, each SQL statement can be executed independently in parallel, using intraquery parallelism when possible. As a consequence, you should limit the use of procedure calls from within data manipulation language (DML) statements if you want to exploit the parallel-processing abilities of the database server. For a complete list of DML statements, see the *IBM Informix Guide to SQL: Syntax*.

The database server uses intraquery parallelism to process the statements in the body of an SQL trigger in the same way that it processes statements in SPL routines.

Correlated and uncorrelated subqueries

The database server does not use PDQ to process correlated subqueries. Only one thread at a time can execute a correlated subquery. While one thread executes a correlated subquery, other threads that request to execute the subquery are blocked until the first one completes.

For uncorrelated subqueries, only the first thread that makes the request actually executes the subquery. Other threads simply use the results of the subquery and can do so in parallel.

As a consequence, it is strongly recommended that, whenever possible, you use joins rather than subqueries to build queries so that the queries can take advantage of PDQ.

OUTER index joins and PDQ

The database server reduces the PDQ priority of queries that contain OUTER index joins to LOW (if the priority is set to a higher value) for the duration of the query. If a subquery or a view contains OUTER index joins, the database server lowers the PDQ priority of only that subquery or view, not of the parent query or any other subquery.

Remote tables used with PDQ

Although the database server can process the data stored in a remote table in parallel, the data is communicated serially because the database server allocates a single thread to submit and receive the data from the remote table. The database server lowers the PDQ priority of queries that require access to a remote database to LOW.

In this case, all local scans are parallel, but all local joins and remote access are nonparallel.

The Memory Grant Manager

The Memory Grant Manager (MGM) is a database server component that coordinates the use of memory, CPU virtual processors (VPs), disk I/O, and scan threads among decision-support queries. The MGM uses the DS_MAX_QUERIES, DS_TOTAL_MEMORY, DS_MAX_SCANS, and MAX_PDQPRIORITY configuration parameters to determine the quantity of these PDQ resources that can be granted to a decision-support query.

For more information about these configuration parameters, see Chapter 4, “Effect of configuration on memory utilization,” on page 4-1.

The MGM dynamically allocates the following resources for decision-support queries:

- The number of scan threads started for each decision-support query
- The number of threads that can be started for each query
- The amount of memory in the virtual portion of database server shared memory that the query can reserve

When your database server system has heavy OLTP use, and you find performance is degrading, you can use the MGM facilities to limit the resources committed to decision-support queries. During off-peak hours, you can designate a larger proportion of the resources to parallel processing, which achieves higher throughput for decision-support queries.

The MGM grants memory to a query for such activities as sorts, hash joins, and processing of GROUP BY clauses. The amount of memory that decision-support queries use cannot exceed DS_TOTAL_MEMORY.

The MGM grants memory to queries in *quantum* increments. To calculate a quantum, use the following formula:

$$\text{memory quantum} = \text{DS_TOTAL_MEMORY} / \text{DS_MAX_QUERIES}$$

For example, if DS_TOTAL_MEMORY is 12 megabytes and DS_MAX_QUERIES is 4, the quantum is 3 megabytes (12/4). Thus, with these values in effect, a quantum of memory equals 3 megabytes. In general, memory is allocated more efficiently when quanta are smaller. You can often improve performance of concurrent queries by increasing DS_MAX_QUERIES to reduce the size of a quantum of memory.

To monitor resources that the MGM allocates, run the **onstat -g mgm** command. This command displays only the amount of memory that is currently used; it does not display the amount of memory that has been granted. For more information about this command, see “Monitoring MGM resources with the **onstat -g mgm** command” on page 12-14.

The MGM also grants a maximum number of scan threads per query based on the values of the DS_MAX_SCANS and the DS_MAX_QUERIES parameters.

The following formula yields the maximum number of scan threads per query:

$$\text{scan_threads} = \min(nfrags, \text{DS_MAX_SCANS} * (\text{pdqpriority} / 100) * (\text{MAX_PDQPRIORITY} / 100))$$

nfrags is the number of fragments in the table with the largest number of fragments.

pdqpriority

is the value for PDQ priority that is set by either the **PDQPRIORITY** environment variable or the SQL statement **SET PDQPRIORITY**.

For more information about any of these database server configuration parameters, see Chapter 4, “Effect of configuration on memory utilization,” on page 4-1.

The **PDQPRIORITY** environment variable and the SQL statement **SET PDQPRIORITY** request a percentage of PDQ resources for a query. You can use the **MAX_PDQPRIORITY** configuration parameter to limit the percentage of the requested resources that a query can obtain and to limit the impact of decision-support queries on OLTP processing. For more information, see “Limiting the priority of decision-support queries.”

The allocation of resources for parallel database queries

When you configure the database server, consider how the use of PDQ affects users of OLTP, decision-support (DSS) applications, and other applications. Then you can plan how to allocate resources for PDQ.

When the database server uses PDQ to perform a query in parallel, it puts a heavy load on the operating system. In particular, PDQ exploits the following resources:

- Memory
- CPU VPs
- Disk I/O (to fragmented tables and temporary table space)
- Scan threads

You can control how the database server uses resources in the following ways:

- Limit the priority of parallel database queries.
- Adjust the amount of memory.
- Limit the number of scan threads.
- Limit the number of concurrent queries.

Limiting the priority of decision-support queries

You can limit the parallel processing resources that decision-support (DSS) queries consume by adjusting the values of **PDQPRIORITY** environment variable, the **MAX_PDQPRIORITY** configuration parameter, and other configuration parameters.

The default value for the PDQ priority of individual applications is 0, which means that PDQ processing is not used. The database server uses this value unless one of the following actions overrides it:

- You set the **PDQPRIORITY** environment variable.
- The application uses the **SET PDQPRIORITY** statement.

The **PDQPRIORITY** environment variable and the **MAX_PDQPRIORITY** configuration parameter work together to control the amount of resources to allocate for parallel processing. Setting these correctly is critical for the effective operation of PDQ.

The **MAX_PDQPRIORITY** configuration parameter allows you to limit the parallel processing resources that DSS queries consume. Thus, the **PDQPRIORITY** environment variable sets a *reasonable* or *recommended* priority value, and **MAX_PDQPRIORITY** limits the resources that an application can claim.

The `MAX_PDQPRIORITY` configuration parameter specifies the maximum percentage of the requested resources that a query can obtain. For instance, if `PDQPRIORITY` is 80 and `MAX_PDQPRIORITY` is 50, each active query receives an amount of memory equal to 40 percent of `DS_TOTAL_MEMORY`, rounded down to the nearest quantum. In this example, `MAX_PDQPRIORITY` effectively limits the number of concurrent decision-support queries to two. Subsequent queries must wait for earlier queries to finish before they acquire the resources that they need to run.

An application or user can use the `DEFAULT` tag of the `SET PDQPRIORITY` statement to use the value for PDQ priority if the value has been set by the `PDQPRIORITY` environment variable. `DEFAULT` is the symbolic equivalent of a -1 value for PDQ priority.

You can use the **onmode** command-line utility to change the values of the following configuration parameters temporarily:

- Use **onmode -M** to change the value of `DS_TOTAL_MEMORY`.
- Use **onmode -Q** to change the value of `DS_MAX_QUERIES`.
- Use **onmode -D** to change the value of `MAX_PDQPRIORITY`.
- Use **onmode -S** to change the value of `DS_MAX_SCANS`.

These changes remain in effect only as long as the database server remains up and running. When the database server starts, it uses the values listed in the `ONCONFIG` file.

For more information about the preceding parameters, see Chapter 4, “Effect of configuration on memory utilization,” on page 4-1. For more information about **onmode**, see your *IBM Informix Administrator’s Reference*.

If you must change the values of the decision-support parameters on a regular basis (for example, to set `MAX_PDQPRIORITY` to 100 each night for processing reports), you can use a scheduled operating-system job to set the values. For information about creating scheduled jobs, see your operating-system manuals.

To obtain the best performance from the database server, choose values for the `PDQPRIORITY` environment variable and `MAX_PDQPRIORITY` parameter, observe the resulting behavior, and then adjust the values for these parameters. No well-defined rules exist for choosing these environment variable and parameter values. The following sections discuss strategies for setting `PDQPRIORITY` and `MAX_PDQPRIORITY` for specific needs.

Limiting the value of the PDQ priority

You can adjust the value of the `MAX_PDQPRIORITY` configuration parameter to adjust the PDQ priority and allocate more resources to either OLTP or decision-support processing.

The `MAX_PDQPRIORITY` configuration parameter limits the PDQ priority that the database server grants when users either set the `PDQPRIORITY` environment variable or issue the `SET PDQPRIORITY` statement before they issue a query. When an application or an end user attempts to set a PDQ priority, the priority that is granted is multiplied by the value that `MAX_PDQPRIORITY` specifies.

Set the value of `MAX_PDQPRIORITY` lower when you want to allocate more resources to OLTP processing.

Set the value of `MAX_PDQPRIORITY` higher when you want to allocate more resources to decision-support processing.

The possible range of values is 0 to 100. This range represents the percent of resources that you can allocate to decision-support processing.

Maximizing OLTP throughput for queries

At times, you might want to allocate resources to maximize the throughput for individual OLTP queries rather than for decision-support queries.

In this case, set `MAX_PDQPRIORITY` to 0, which limits the value of PDQ priority to OFF. A PDQ priority value of OFF does not prevent decision-support queries from running. Instead, it causes the queries to run without parallelization. In this configuration, response times for decision-support queries might be slow.

Conserving resources when using PDQ

If applications make little use of queries that require parallel sorts and parallel joins, consider using the LOW setting for PDQ priority.

If the database server is operating in a multiuser environment, you might set `MAX_PDQPRIORITY` to 1 to increase interquery performance at the cost of some intraquery parallelism. A trade-off exists between these two different types of parallelism because they compete for the same resources. As a compromise, you might set `MAX_PDQPRIORITY` to some intermediate value (perhaps 20 or 30) and set `PDQPRIORITY` to LOW. The environment variable sets the default behavior to LOW, but the `MAX_PDQPRIORITY` configuration parameter allows individual applications to request more resources with the `SET PDQPRIORITY` statement.

Allowing maximum use of parallel processing

Set `PDQPRIORITY` and `MAX_PDQPRIORITY` to 100 if you want the database server to assign as many resources as possible to parallel processing.

This setting is appropriate for times when parallel processing does not interfere with OLTP processing.

Determining the level of parallel processing

You can use different numeric settings for `PDQPRIORITY` to experiment with the effects of parallelism on a single application.

For information about how to monitor parallel execution, see “Monitoring resources used for PDQ and DSS queries” on page 12-14.

Limits on parallel operations associated with PDQ priority

The database server reduces the PDQ priority of queries that contain outer joins to LOW (if set to a higher value) for the duration of the query. If a subquery or a view contains outer joins, the database server lowers the PDQ priority only of that subquery or view, not of the parent query or of any other subquery.

The database server lowers the PDQ priority of queries that require access to a remote database (same or different database server instance) to LOW if you set it to a higher value. In that case, all local scans are parallel, but all local joins and remote accesses are nonparallel.

Using SPL routines with PDQ queries

The database server freezes the PDQ priority that is used to optimize SQL statements within SPL routines at the time of procedure creation or the last manual recompilation with the UPDATE STATISTICS statement. You can change the client value of **PDQPRIORITY**.

To change the client value of **PDQPRIORITY**, embed the SET PDQPRIORITY statement within the body of your SPL routine.

The PDQ priority value that the database server uses to optimize or reoptimize an SQL statement is the value that was set by a SET PDQPRIORITY statement, which must have been executed within the same procedure. If no such statement has been executed, the value that was in effect when the procedure was last compiled or created is used.

The PDQ priority value currently in effect outside a procedure is ignored within a procedure when it is executing.

It is suggested that you turn PDQ priority off when you enter a procedure and then turn it on again for specific statements. You can avoid tying up large amounts of memory for the procedure, and you can make sure that the crucial parts of the procedure use the appropriate PDQ priority, as the following example illustrates:

```
CREATE PROCEDURE my_proc (a INT, b INT, c INT)
  Returning INT, INT, INT;
SET PDQPRIORITY 0;
...
SET PDQPRIORITY 85;
SELECT ... (big complicated SELECT statement)
SET PDQPRIORITY 0;
...
;
```

Adjusting the amount of memory for DSS and PDQ queries

You can estimate the amount of shared memory to allocate to decision-support (DSS) queries. Then, if necessary, you can adjust the value of the DS_TOTAL_MEMORY configuration parameter, which specifies the amount of memory available for PDQ queries.

Use the following formula as a starting point for estimating the amount of shared memory to allocate to DSS queries:

$$DS_TOTAL_MEMORY = p_mem - os_mem - rsdnt_mem - (128 \text{ kilobytes} * users) - other_mem$$

p_mem represents the total physical memory that is available on the host computer.

os_mem represents the size of the operating system, including the buffer cache.

rsdnt_mem represents the size of Informix resident shared memory.

users is the number of expected users (connections) specified in the NETTYPE configuration parameter.

other_mem is the size of memory used for other (non-IBM Informix) applications.

The value for `DS_TOTAL_MEMORY` that is derived from this formula serves only as a starting point. To arrive at a value that makes sense for your configuration, you must monitor paging and swapping. (Use the tools provided with your operating system to monitor paging and swapping.) When paging increases, decrease the value of `DS_TOTAL_MEMORY` so that processing the OLTP workload can proceed.

The amount of memory that is granted to a single parallel database query depends on many system factors, but in general, the amount of memory granted to a single parallel database query is proportional to the following formula:

$$\text{memory_grant_basis} = (\text{DS_TOTAL_MEMORY} / \text{DS_MAX_QUERIES}) * (\text{PDQPRIORITY} / 100) * (\text{MAX_PDQPRIORITY} / 100)$$

However, if the currently executing queries on all databases of the server instance require more memory than this estimate of the average allocation, another query might overflow to disk or might wait until concurrent queries completed execution and released sufficient memory resources for running the query. The following alternative formula estimates the PDQ memory available for a single query directly:

$$\text{memory_for_single_query} = \text{DS_TOTAL_MEMORY} * (\text{PDQPRIORITY} / 100) * (\text{MAX_PDQPRIORITY} / 100)$$

Limiting the number of concurrent scans

The database server apportions some number of scans to a query according to its PDQ priority (among other factors). You can adjust the value of the `DS_MAX_SCANS` configuration parameter to limit the number of concurrent scans.

The `DS_MAX_SCANS` and `MAX_PDQPRIORITY` configuration parameters allow you to limit the resources that users can assign to a query, according to the following formula:

$$\text{scan_threads} = \min(nfrags, (\text{DS_MAX_SCANS} * (\text{pdqpriority} / 100) * (\text{MAX_PDQPRIORITY} / 100)))$$

nfrags is the number of fragments in the table with the largest number of fragments.

pdqpriority

is the PDQ priority value set by either the `PDQPRIORITY` environment variable or the `SET PDQPRIORITY` statement.

For example, suppose a large table contains 100 fragments. With no limit on the number of concurrent scans allowed, the database server would concurrently execute 100 scan threads to read this table. In addition, many users could initiate this query.

As the database server administrator, you set the `DS_MAX_SCANS` configuration parameter to a value lower than the number of fragments in this table to prevent the database server from being flooded with scan threads by multiple decision-support queries. You can set `DS_MAX_SCANS` to 20 to ensure that the database server concurrently executes a maximum of 20 scan threads for parallel scans. Furthermore, if multiple users initiate parallel database queries, each query receives only a percentage of the 20 scan threads, according to the PDQ priority assigned to the query and the value for the `MAX_PDQPRIORITY` configuration parameter that the database server administrator sets.

Limiting the maximum number of PDQ queries

You can adjust the maximum number of PDQ queries that can run concurrently by changing the value of the `DS_MAX_QUERIES` configuration parameter.

The `DS_MAX_QUERIES` configuration parameter limits the number of concurrent decision-support queries that can run.

To estimate the number of decision-support (DSS) queries that the database server can run concurrently, count each query that runs with PDQ priority set to 1 or greater as one full query.

The database server allocates less memory to queries that run with a lower priority, so you can assign lower-priority queries a PDQ priority value that is between 1 and 30, depending on the resource impact of the query. The total number of queries with PDQ priority values greater than 0 cannot exceed the value of `DS_MAX_QUERIES`.

Managing PDQ queries

The database server administrator, the writer of an application, and the users all have a certain amount of control over the amount of resources that Informix allocates to processing a query. The database server administrator exerts control through the use of configuration parameters. The application developer or the user can exert control through an environment variable or SQL statement.

Analyzing query plans with SET EXPLAIN output

You can use SET EXPLAIN output to study the query plans of an application. The output of the SET EXPLAIN statement shows decisions that the query optimizer makes. It shows whether parallel scans are used, the maximum number of threads required to answer the query, and the type of join used for the query.

You can restructure a query or use OPTCOMPIND to change how the optimizer treats the query.

Influencing the choice of a query plan

The `OPTCOMPIND` environment variable and the `OPTCOMPIND` configuration parameter indicate the preferred join plan, thus assisting the optimizer in selecting the appropriate join method for parallel database queries. To influence the optimizer in its choice of a join plan, you can set the `OPTCOMPIND` configuration parameter.

The value that you assign to the `OPTCOMPIND` configuration parameter is referenced only when applications do not set the `OPTCOMPIND` environment variable.

Set `OPTCOMPIND` to 0 if you want the database server to select a join plan exactly as it did in versions of the database server prior to version 6.0. This option ensures compatibility with previous versions of the database server.

An application with an isolation mode of Repeatable Read can lock all records in a table when it performs a hash join. For this reason, you should set `OPTCOMPIND` to 1.

If you want the optimizer to make the determination for you based on cost, regardless of the isolation level of applications, set OPTCOMPIND to 2.

You can use the SET ENVIRONMENT OPTCOMPIND command to change the value of OPTCOMPIND within a session. For more information about using this command, see “Setting the value of OPTCOMPIND within a session” on page 3-10.

For more information about OPTCOMPIND and the different join plans, see “The query plan” on page 10-1.

Setting the PDQ priority dynamically

You can use the SET PDQPRIORITY statement to set PDQ priority dynamically within an application. The PDQ priority value can be any integer from -1 through 100.

The PDQ priority set with the SET PDQPRIORITY statement supersedes the PDQPRIORITY environment variable.

The DEFAULT tag for the SET PDQPRIORITY statement allows an application to revert to the value for PDQ priority as set by the environment variable, if any. For more information about the SET PDQPRIORITY statement, see the *IBM Informix Guide to SQL: Syntax*.

User control of PDQ resources

To indicate the PDQ priority of a query, you can set the PDQPRIORITY environment variable or execute the SET PDQPRIORITY statement prior to issuing a query. These PDQ priority options allow you to request a certain amount of parallel-processing resources for the query.

The resources that you request and the amount of resources that the database server allocates for the query can differ. This difference occurs when the database server administrator uses the MAX_PDQPRIORITY configuration parameter to put a ceiling on user-requested resources, as the following topic explains.

DBA control of resources for PDQ and DSS queries

To manage the total amount of resources that the database server allocates to parallel database and decision-support (DSS) queries, the database server administrator can set the environment variable and configuration parameters.

Controlling resources allocated to PDQ

To control resources allocated to PDQ, you can set the PDQPRIORITY environment variable. The queries that do not set the PDQPRIORITY environment variable before they issue a query do not use PDQ. In addition, to place a ceiling on user-specified PDQ priority levels, you can set the MAX_PDQPRIORITY configuration parameter.

When you set the PDQPRIORITY environment variable and MAX_PDQPRIORITY parameter, you exert control over the resources that the database server allocates between OLTP and DSS applications. For example, if OLTP processing is particularly heavy during a certain period of the day, you might want to set MAX_PDQPRIORITY to 0. This configuration parameter puts a ceiling on the resources requested by users who use the PDQPRIORITY environment variable, so PDQ is turned off until you reset MAX_PDQPRIORITY to a nonzero value.

DBA control of resources allocated to decision-support queries

A DBA can control the resources that the database server allocates to decision-support queries by setting the `DS_TOTAL_MEMORY`, `DS_MAX_SCANS`, and `DS_MAX_QUERIES` configuration parameters.

In addition to setting limits for decision-support memory and the number of decision-support queries that can run concurrently, the database server uses these parameters to determine the amount of memory to allocate to individual decision-support queries as users submit them. To do so, the database server first calculates a unit of memory called a *quantum* by dividing `DS_TOTAL_MEMORY` by `DS_MAX_QUERIES`. When a user issues a query, the database server allocates a percent of the available quanta equal to the PDQ priority of the query.

You can also limit the number of concurrent decision-support scans that the database server allows by setting the `DS_MAX_SCANS` configuration parameter.

Previous versions of the database server allowed you to set a PDQ priority configuration parameter in the `ONCONFIG` file. If your applications depend on a global setting for PDQ priority, you can use one of the following methods:

- For UNIX: Define **PDQPRIORITY** as a shared environment variable in the `informix.rc` file. For more information about the `informix.rc` file, see the *IBM Informix Guide to SQL: Reference*.
- For Windows: Set the **PDQPRIORITY** environment variable for a particular group through a logon profile. For more information about the logon profile, see your operating-system manual.

Monitoring resources used for PDQ and DSS queries

You can monitor the resources (shared memory and threads) that the Memory Grant Manager (MGM) has allocated for PDQ queries and the resources that PDQ and decision-support (DSS) queries currently use.

You monitor PDQ resource use in the following ways:

- Run individual **onstat** utility commands to capture information about specific aspects of a running query.
- Execute a `SET EXPLAIN` statement before you run a query to write the query plan to an output file.

Monitoring PDQ resources by using the **onstat** Utility

You can use various **onstat** utility commands to determine how many threads are active and the shared-memory resources that those threads use.

Monitoring MGM resources with the **onstat -g mgm** command

You can use the **onstat -g mgm** command to monitor how the Memory Grant Manager (MGM) coordinates memory use and to scan threads. The **onstat** utility reads shared-memory structures and provides statistics that are accurate at the instant that the command executes.

Figure 12-1 on page 12-15 shows sample output.

The **onstat -g mgm** output displays a unit of memory called a *quantum*. The *memory quantum* represents a unit of memory, as follows:

`memory quantum = DS_TOTAL_MEMORY / DS_MAX_QUERIES`

The following calculation shows the memory quantum for the values that Figure 12-1 displays:

$$\begin{aligned} \text{memory quantum} &= 4000 \text{ kilobytes} / 5 \\ &= 800 \text{ kilobytes} \end{aligned}$$

The *scan thread quantum* is always equal to 1.

```

Memory Grant Manager (MGM)
-----

MAX_PDQPRIORITY: 100
DS_MAX_QUERIES: 5
DS_MAX_SCANS: 10
DS_TOTAL_MEMORY: 4000 KB

Queries:  Active      Ready  Maximum
          3           0       5

Memory:   Total      Free   Quantum
(KB)     4000      3872    800

Scans:    Total      Free   Quantum
          10       8       1

Load Control:  (Memory)      (Scans)  (Priority)  (Max Queries)  (Reinit)
                Gate 1      Gate 2    Gate 3      Gate 4      Gate 5
(Queue Length) 0           0         0           0           0

Active Queries:
-----
Session  Query  Priority  Thread  Memory  Scans  Gate
   7     a3d0c0    1    a8adcc  0/0     1/1    -
   7     a56eb0    1    ae6800  0/0     1/1    -
   9     a751d4    0    96b1b8 16/16    0/0    -

Ready Queries: None

Free Resource      Average #      Minimum #
-----
Memory             489.2 +- 28.7      400
Scans              8.5 +- 0.5         8

Queries            Average #      Maximum #      Total #
-----
Active             1.7 +- 0.7         3              23
Ready              0.0 +- 0.0         0              0

Resource/Lock Cycle Prevention count: 0

```

Figure 12-1. `onstat -g mgm` output

Explanation of the sample `onstat -g mgm` output:

The first portion of `onstat -g mgm` output shows the values of the PDQ configuration parameters. The second portion of the output describes Memory Grant Manager (MGM) internal control information. It includes four groups of information.

The first group of MGM internal control information is **Queries**. The group contains this information:

Column	Description
Active	Number of PDQ queries that are currently executing
Ready	Number of user queries ready to run but whose execution the database server deferred for load-control reasons
Maximum	Maximum number of queries that the database server permits to be active. Reflects current value of the DS_MAX_QUERIES configuration parameter

The next group is **Memory**. The group contains this information:

Column	Description
Total	Kilobytes of memory available for use by PDQ queries (DS_TOTAL_MEMORY specifies this value.)
Free	Kilobytes of memory for PDQ queries not currently in use
Quantum	Kilobytes of memory in a memory quantum

The next group is **Scans**. The group contains this information:

Column	Description
Total	The total number of scan threads as specified by the DS_MAX_SCANS configuration parameter
Free	Number of scan threads currently available for decision-support queries
Quantum	The number of scan threads in a scan-thread quantum

The last group in this portion of the output describes **MGM Load Control**. The group contains this information:

Column	Description
Memory	Number of queries that are waiting for memory
Scans	Number of queries that are waiting for scans
Priority	Number of queries that are waiting for queries with higher PDQ priority to run
Max Queries	Number of queries that are waiting for a query slot
Reinit	Number of queries that are waiting for running queries to complete after an onmode -M, -p, or -Q command

The next portion of the output, **Active Queries**, describes the MGM active and ready queues. This portion of the output shows the number of queries waiting at each gate.

Column	Description
Session	The session ID for the session that initiated the query
Query	Address of the internal control block associated with the query
Priority	PDQ priority assigned to the query
Thread	Thread that registered the query with MGM

Column	Description
Memory	Memory currently granted to the query or memory reserved for the query
Scans	Number of scan threads currently used by the query or number of scan threads allocated to the query
Gate	Gate number at which query is waiting

The next portion of the output, **Free Resource**, provides statistics for MGM free resources. The numbers in this portion and in the final portion reflect statistics since system initialization or the last **onmode -Q**, **-M**, or **-S** command. This portion of the output contains the following information:

Column	Description
Average	Average amount of memory and number of scans
Minimum	Minimum available memory and number of scans

The last portion of the output, **Queries**, provides statistics concerning MGM queries:

Column	Description
Average	Average active and ready queue length
Maximum	Maximum active and ready queue length
Total	Total active and ready queue length
Resource/Lock Cycle Prevention count	Number of times the system immediately activated a query to avoid a potential deadlock The database server can detect when some of the queries in its queue might create a deadlock situation if the queries are not run immediately.

Monitoring PDQ threads with onstat utility commands

You can obtain information about all of the threads that are running for a decision-support query by running the **onstat -u** and **onstat -g ath** commands.

The **onstat -u** option lists all the threads for a session. If a session is running a decision-support query, the output lists the primary thread and any additional threads. For example, session 10 in Figure 12-2 on page 12-18 has a total of five threads running.

Userthreads									
address	flags	sessid	user	tty	wait	tout	locks	nreads	nwrites
80eb8c	---P--D	0	informix	-	0	0	0	33	19
80ef18	---P--F	0	informix	-	0	0	0	0	0
80f2a4	---P--B	3	informix	-	0	0	0	0	0
80f630	---P--D	0	informix	-	0	0	0	0	0
80fd48	---P---	45	chrisw	ttyp3	0	0	1	573	237
810460	-----	10	chrisw	ttyp2	0	0	1	1	0
810b78	---PR--	42	chrisw	ttyp3	0	0	1	595	243
810f04	Y-----	10	chrisw	ttyp2	beacf8	0	1	1	0
811290	---P---	47	chrisw	ttyp3	0	0	2	585	235
81161c	---PR--	46	chrisw	ttyp3	0	0	1	571	239
8119a8	Y-----	10	chrisw	ttyp2	a8a944	0	1	1	0
81244c	---P---	43	chrisw	ttyp3	0	0	2	588	230
8127d8	----R--	10	chrisw	ttyp2	0	0	1	1	0
812b64	---P---	10	chrisw	ttyp2	0	0	1	20	0
812ef0	---PR--	44	chrisw	ttyp3	0	0	1	587	227
15 active, 20 total, 17 maximum concurrent									

Figure 12-2. *onstat -u* output

The **onstat -g ath** output also lists these threads and includes a **name** column that indicates the role of the thread. Threads that a primary decision-support thread started have a name that indicates their role in the decision-support query. For example, Figure 12-3 lists four *scan* threads, started by a primary thread (**sqlxec**).

Threads:						
tid	tcb	rstcb	prty	status	vp-class	name
...						
11	994060	0	4	sleeping(Forever)	1cpu	kaio
12	994394	80f2a4	2	sleeping(secs: 51)	1cpu	btclean
26	99b11c	80f630	4	ready	1cpu	onmode_mon
32	a9a294	812b64	2	ready	1cpu	sqlxec
113	b72a7c	810b78	2	ready	1cpu	sqlxec
114	b86c8c	81244c	2	cond wait(netnorm)	1cpu	sqlxec
115	b98a7c	812ef0	2	cond wait(netnorm)	1cpu	sqlxec
116	bb4a24	80fd48	2	cond wait(netnorm)	1cpu	sqlxec
117	bc6a24	81161c	2	cond wait(netnorm)	1cpu	sqlxec
118	bd8a24	811290	2	ready	1cpu	sqlxec
119	beae88	810f04	2	cond wait(await_MC1)	1cpu	scan_1.0
120	a8ab48	8127d8	2	ready	1cpu	scan_2.0
121	a96850	810460	2	ready	1cpu	scan_2.1
122	ab6f30	8119a8	2	running	1cpu	scan_2.2

Figure 12-3. *onstat -g ath* Output

Monitoring resources allocated for a session running a DSS query

You can monitor the resources allocated for, and used by, a session that is running a decision-support (DSS) query by running the **onstat -g ses** command.

The **onstat -g ses** option displays the following information:

- The shared memory allocated for a session that is running a decision-support query
- The shared memory used by a session that is running a decision-support query
- The number of threads that the database server started for a session

For example, in Figure 12-4, session number 49 is running five threads for a decision-support query.

session					#RSAM	total	used
id	user	tty	pid	hostname	threads	memory	memory
57	informix	-	0	-	0	8192	5908
56	user_3	ttyp3	2318	host_10	1	65536	62404
55	user_3	ttyp3	2316	host_10	1	65536	62416
54	user_3	ttyp3	2320	host_10	1	65536	62416
53	user_3	ttyp3	2317	host_10	1	65536	62416
52	user_3	ttyp3	2319	host_10	1	65536	62416
51	user_3	ttyp3	2321	host_10	1	65536	62416
49	user_1	ttyp2	2308	host_10	5	188416	178936
2	informix	-	0	-	0	8192	6780
1	informix	-	0	-	0	8192	4796

Figure 12-4. *onstat -g ses* output

Identifying parallel scans in SET EXPLAIN output

When PDQ is turned on, the SET EXPLAIN output shows whether the optimizer chose parallel scans. If the optimizer chose parallel scans, the output lists *Parallel*. (If PDQ is turned off, the output lists *Serial*.)

If PDQ is turned on, the optimizer also indicates the maximum number of threads that are required to answer the query. The # of Secondary Threads field in the SET EXPLAIN output indicates the number of threads that are required in addition to your user session thread. The total number of threads necessary is the number of secondary threads plus 1.

The following example shows SET EXPLAIN output for a table with fragmentation and PDQ priority set to LOW:

```
SELECT * FROM t1 WHERE c1 > 20
```

```
Estimated Cost: 2
Estimated # of Rows Returned: 2
```

```
1) informix.t1: SEQUENTIAL SCAN (Parallel, fragments: 2)
```

```
Filters: informix.t1.c1 > 20
```

```
# of Secondary Threads = 1
```

The following example of partial SET EXPLAIN output shows a query with a hash join between two fragmented tables and PDQ priority set to ON. The query is marked with DYNAMIC HASH JOIN, and the table on which the hash is built is marked with Build Outer.

```
QUERY:
```

```
-----
SELECT h1.c1, h2.c1 FROM h1, h2 WHERE h1.c1 = h2.c1
```

```
Estimated Cost: 2
Estimated # of Rows Returned: 5
```

```
1) informix.h1: SEQUENTIAL SCAN (Parallel, fragments: ALL)
```

```
2) informix.h2: SEQUENTIAL SCAN (Parallel, fragments: ALL)
```

```
DYNAMIC HASH JOIN (Build Outer)
  Dynamic Hash Filters: informix.h1.c1 = informix.h2.c1
```

```
# of Secondary Threads = 6
```

The following example of partial SET EXPLAIN output shows a table with fragmentation, PDQ priority set to LOW, and an index that was selected as the access plan:

```
SELECT * FROM t1 WHERE c1 < 13
```

```
Estimated Cost: 2
```

```
Estimated # of Rows Returned: 1
```

```
1) informix.t1: INDEX PATH
```

```
(1) Index Keys: c1 (Parallel, fragments: ALL)
Upper Index Filter: informix.t1.c1 < 13
```

```
# of Secondary Threads = 3
```

Chapter 13. Improving individual query performance

You can test, monitor, and improve queries.

Test queries using a dedicated test system

You can test a query on a system that does not interfere with production database servers. However, you must be careful, because testing queries on a separate system might distort your tuning decisions.

Even if you use your database server as a data warehouse, you might sometimes test queries on a separate system until you understand the tuning issues that are relevant to the query.

If you are trying to improve performance of a large query, one that might take several minutes or hours to complete, you can prepare a scaled-down database in which your tests can complete more quickly. However, be aware of these potential problems:

- The optimizer can make different choices in a small database than in a large one, even when the relative sizes of tables are the same. Verify that the query plan is the same in the real and the model databases.
- Execution time is rarely a linear function of table size. For example, sorting time increases faster than table size, as does the cost of indexed access when an index goes from two to three levels. What appears to be a big improvement in the scaled-down environment can be insignificant when applied to the full database.

Therefore, any conclusion that you reach as a result of tests in the model database must be tentative until you verify them in the production database.

You can often improve performance by adjusting your query or data model with the following goals in mind:

- If you are using a multiuser system or a network, where system load varies widely from hour to hour, try to perform your experiments at the same time each day to obtain repeatable results. Start tests when the system load is consistently light so that you are truly measuring the impact of your query only.
- If the query is embedded in a complicated program, you can extract the SELECT statement and embed it in a DB-Access script.

Display the query plan

Before you change a query, display its query plan to determine the kind and amount of resources that the query requires. The query plan shows what parallel scans are used, the maximum number of threads required, and the indexes used.

After you study the query plan, examine your data model to see if the changes this chapter suggests will improve the query.

You can display the query plan with one of the following methods:

- Execute one of the following SET EXPLAIN statements just before the query:
 - SET EXPLAIN ON

This SQL statement displays the chosen query plan. For a description of the SET EXPLAIN ON output, see “Report that shows the query plan chosen by the optimizer” on page 10-9.

- SET EXPLAIN ON AVOID_EXECUTE

This SQL statement displays the chosen query plan and does not execute the query.

- Use one of the following EXPLAIN directives in the query:
 - EXPLAIN
 - EXPLAIN AVOID_EXECUTE

For more information about these EXPLAIN directives, see “EXPLAIN directives” on page 11-10.

Improve filter selectivity

You can control the amount of information that a query evaluates. The greater the precision with which you specify the desired rows, the greater the likelihood that your queries will complete quickly.

To control the amount of information that the query evaluates, use the WHERE clause of the SELECT statement. The conditional expression in the WHERE clause is commonly called a *filter*.

For information about how filter selectivity affects the query plan that the optimizer chooses, see “Filters in the query” on page 10-19. The following sections provide some guidelines to improve filter selectivity.

Filters with user-defined routines

You can improve the selectivity of query filters that include user-defined routines (UDRs).

You can improve the selectivity if the UDRs have the following features:

- Functional indexes

You can create a *functional index* on the resulting values of a user-defined routine or a built-in function that operates on one or more columns. When you create a functional index, the database server computes the return values of the function and stores them in the index. The database server can locate the return value of the function in an appropriate index without executing the function for each qualifying column.

For more information about indexing user-defined functions, see “Using a functional index” on page 7-20.

- User-defined selectivity functions

You can write a function that calculates the expected fraction of rows that qualify for the function. For a brief description of user-defined selectivity functions, see “Selectivity and cost functions” on page 13-38. For more information about how to write and register user-defined selectivity functions, see *IBM Informix User-Defined Routines and Data Types Developer's Guide*.

Avoid some filters

For best performance, avoid filters for certain difficult regular expressions and filters for noninitial strings.

Avoid difficult regular expressions

The MATCHES and LIKE keywords support *wildcard* matches, which are technically known as *regular expressions*. Some regular expressions are more difficult than others for the database server to process.

A wildcard in the initial position, as in the following example (find customers whose first names do not end in *y*), forces the database server to examine every value in the column:

```
SELECT * FROM customer WHERE fname NOT LIKE '%y'
```

You cannot use an index with such a filter, so the table in this example must be accessed sequentially.

If a difficult test for a regular expression is essential, avoid combining it with a join. If necessary, process the single table and apply the test for a regular expression to select the desired rows. Save the result in a temporary table and join that table to the others.

Regular-expression tests with wildcards in the middle or at the end of the operand do not prevent the use of an index when one exists.

Avoid noninitial substrings

For best performance, avoid filters for noninitial strings. A filter based on a noninitial substring of a column requires the database server to test every value in the column.

For example, in the following code, a noninitial substring requires the database server to test every value in the column:

```
SELECT * FROM customer
WHERE zipcode[4,5] > '50'
```

The database server cannot use an index to evaluate such a filter.

The optimizer uses an index to process a filter that tests an initial substring of an indexed column. However, the presence of the substring test can interfere with the use of a composite index to test both the substring column and another column.

Use join filters and post-join filters

The database server provides support for using a subset of the ANSI join syntax.

This syntax that includes the following keywords:

- ON keyword to specify the join condition and any optional join filters
- LEFT OUTER JOIN keywords to specify which table is the dominant table (also referred to as *outer table*)

For more information about this ANSI join syntax, see the *IBM Informix Guide to SQL: Syntax*.

In an ANSI outer join, the database server takes the following actions to process the filters:

- Applies the join condition in the ON clause to determine which rows of the subordinate table (also referred to as *inner table*) to join to the outer table
- Applies optional join filters in the ON clause before and during the join

If you specify a join filter on a base inner table in the ON clause, the database server can apply it prior to the join, during the scan of the data from the inner table. Filters on a base subordinate table in the ON clause can provide the following additional performance benefits:

- Fewer rows to scan from the inner table prior to the join
- Use of index to retrieve rows from the inner table prior to the join
- Fewer rows to join
- Fewer rows to evaluate for filters in the WHERE clause

For information about what occurs when you specify a join filter on an outer table in the ON clause, see the *IBM Informix Guide to SQL: Syntax*.

- Applies filters in the WHERE clause after the join

Filters in the WHERE clause can reduce the number of rows that the database server needs to scan and reduce the number of rows returned to the user.

The term *post-join filters* refers to these WHERE clause filters.

When distributed queries that use ANSI-compliant LEFT OUTER syntax for specifying joined tables and nested loop joins are executed, the query is sent to each participating database server for operations on local tables of those servers.

For example, the demonstration database has the **customer** table and the **cust_calls** table, which tracks customer calls to the service department. Suppose a certain call code had many occurrences in the past, and you want to see if calls of this kind have decreased. To see if customers no longer have this call code, use an outer join to list all customers.

Figure 13-1 shows a sample SQL statement to accomplish this ANSI join query and the SET EXPLAIN ON output for it.

```
QUERY:
-----
SELECT c.customer_num, c.lname, c.company,
       c.phone, u.call_dtime, u.call_code, u.call_descr
FROM customer c
LEFT JOIN cust_calls u ON c.customer_num = u.customer_num
ORDER BY u.call_dtime

Estimated Cost: 14
Estimated # of Rows Returned: 29
Temporary Files Required For: Order By

1) virginia.c: SEQUENTIAL SCAN

2) virginia.u: INDEX PATH

   (1) Index Keys: customer_num call_dtime (Serial, fragments: ALL)
       Lower Index Filter: virginia.c.customer_num = virginia.u.customer_num

ON-Filters:virginia.c.customer_num = virginia.u.customer_num
NESTED LOOP JOIN(LEFT OUTER JOIN)
```

Figure 13-1. SET EXPLAIN ON output for an ANSI join

Look at the following lines in the SET EXPLAIN ON output in Figure 13-1:

- The ON-Filters: line lists the join condition that was specified in the ON clause.

- The last line of the SET EXPLAIN ON output shows all three keywords (LEFT OUTER JOIN) for the ANSI join even though this query specifies only the LEFT JOIN keywords in the FROM clause. The OUTER keyword is optional.

Figure 13-2 shows the SET EXPLAIN ON output for an ANSI join with a join filter that checks for calls with the I call_code.

```

QUERY:
-----
SELECT c.customer_num, c.lname, c.company,
c.phone, u.call_dtime, u.call_code, u.call_descr
FROM customer c LEFT JOIN cust_calls u
ON c.customer_num = u.customer_num
AND u.call_code = 'I'
ORDER BY u.call_dtime

Estimated Cost: 13
Estimated # of Rows Returned: 25
Temporary Files Required For: Order By

  1) virginia.c: SEQUENTIAL SCAN

  2) virginia.u: INDEX PATH

    Filters: virginia.u.call_code = 'I'

      (1) Index Keys: customer_num call_dtime (Serial, fragments: ALL)
          Lower Index Filter: virginia.c.customer_num = virginia.u.customer_num

ON-Filters:(virginia.c.customer_num = virginia.u.customer_num
            AND virginia.u.call_code = 'I' )
NESTED LOOP JOIN(LEFT OUTER JOIN)

```

Figure 13-2. SET EXPLAIN ON output for a join filter in an ANSI join

The main differences between the output in Figure 13-1 on page 13-4 and Figure 13-2 are as follows:

- The optimizer chooses a different index to scan the inner table. This new index exploits more filters and retrieves a smaller number of rows. Consequently, the join operates on fewer rows.
- The ON clause join filter contains an additional filter.

The value in the Estimated # of Rows Returned line is only an estimate and does not always reflect the actual number of rows returned. The sample query in Figure 13-2 returns fewer rows than the query in Figure 13-1 on page 13-4 because of the additional filter.

Figure 13-3 on page 13-6 shows the SET EXPLAIN ON output for an ANSI join query that has a filter in the WHERE clause.

```

QUERY:
-----
SELECT c.customer_num, c.lname, c.company,
       c.phone, u.call_dtime, u.call_code, u.call_descr
FROM customer c LEFT JOIN cust_calls u
ON c.customer_num = u.customer_num
   AND u.call_code = 'I'
WHERE c.zipcode = "94040"
ORDER BY u.call_dtime

Estimated Cost: 3
Estimated # of Rows Returned: 1
Temporary Files Required For: Order By

1) virginia.c: INDEX PATH

   (1) Index Keys: zipcode      (Serial, fragments: ALL)
       Lower Index Filter: virginia.c.zipcode = '94040'

2) virginia.u: INDEX PATH

   Filters: virginia.u.call_code = 'I'

   (1) Index Keys: customer_num call_dtime  (Serial, fragments: ALL)
       Lower Index Filter: virginia.c.customer_num = virginia.u.customer_num

ON-Filters:(virginia.c.customer_num = virginia.u.customer_num
            AND virginia.u.call_code = 'I' )
NESTED LOOP JOIN(LEFT OUTER JOIN)

PostJoin-Filters:virginia.c.zipcode = '94040'

```

Figure 13-3. SET EXPLAIN ON output for the WHERE clause filter in an ANSI join

The main differences between the output in Figure 13-2 on page 13-5 and Figure 13-3 are as follows:

- The index on the **zipcode** column in the post-join filter is chosen for the dominant table.
- The PostJoin-Filters line shows the filter in the WHERE clause.

Automatic statistics updating

The database server updates statistics automatically according to a predefined schedule and a set of expiration policies. The Auto Update Statistics (AUS) maintenance system identifies tables and indexes that require new optimizer statistics and runs the appropriate UPDATE STATISTICS statements to optimize query performance.

The AUS maintenance system updates the statistics for tables that are in logged databases, regardless of the database locale. By making current table statistics available to the query optimizer, the AUS maintenance system can reduce the risk of performance degradation from inefficient query plans.

Depending on your system, you might need to adjust the AUS expiration policies or schedule. The AUS maintenance system resides in the **sysadmin** database.

You can also view and adjust the AUS maintenance system for table statistics in the IBM OpenAdmin Tool (OAT) for Informix.

Related concepts

“Update statistics when they are not generated automatically” on page 13-11

How AUS works

The Auto Update Statistics (AUS) maintenance system uses a combination of Scheduler sensors, tasks, thresholds, and tables to evaluate and update statistics.

The Scheduler tasks, sensors, thresholds, and tables reside in the **sysadmin** database. By default, only user **informix** is granted access to the **sysadmin** database.

The following sequence of events describes how statistics are automatically updated:

1. The **mon_table_profile** sensor of the Scheduler runs every day to read data from the **systables** table in the **sysmaster** database. The sensor updates the **mon_table_profile** table in the **sysadmin** database with information about how much each table has changed.
2. The Auto Update Statistics Evaluation task gathers information every day from the **mon_table_profile** table and the **systable**, **sysdistrib**, **syscolumns**, and **sysindices** tables in the **sysmaster** database.
3. The Auto Update Statistics Evaluation task determines which tables need updates based on the expiration policies.
4. The Auto Update Statistics Evaluation task generates UPDATE STATISTICS statements and inserts them into the **aus_command** table in the **sysadmin** database.
5. The Auto Update Statistics Refresh task runs the UPDATE STATISTICS statements from the **aus_command** table on Saturday and Sunday mornings between 1:00 AM and 5:00 AM and inserts the results back into the **aus_command** table. Any UPDATE STATISTICS statements that did not complete before 5:00 AM remain in the **aus_command** table.

The following table describes the tasks, sensors, thresholds, tables, and views in the **sysadmin** database that comprise the AUS maintenance system.

Table 13-1. AUS components

Component	Type	Description
mon_table_profile	sensor	Compiles table profile information, including the total number of updates, inserts, and deletes that occurred on each table. Defined in the ph_task table.
mon_table_profile	table	Stores table profile information gathered by its sensor. Many other Scheduler tasks use information from this table.
Auto Update Statistics Evaluation	task	Identifies tables with stale statistics, based on expiration policies, and generates UPDATE STATISTICS statements for those tables. Defined in the ph_task table.

Table 13-1. AUS components (continued)

Component	Type	Description
aus_command	table	Stores a list of prioritized UPDATE STATISTICS statements that are scheduled to be run, and the results of those statements after they are run. The aus_cmd_state column indicates the status of each UPDATE STATISTICS statement: <ul style="list-style-type: none"> • P = Pending • I = In progress • E = Error • C = Complete without errors If the command status is E, the associated SQL error code is listed in the aus_cmd_err_sql column and the associated ISAM error code is listed in the aus_cmd_err_isam column.
Auto Update Statistics Refresh	task	Runs the prepared UPDATE STATISTICS statements on Saturdays and Sundays between 1:00 AM and 5:00 AM. Defined in the ph_task table.
expiration policies	thresholds	Define the criteria for when to update statistics. Defined in the ph_threshold table.
aus_cmd_comp	view	Shows information from the aus_command table about UPDATE STATISTICS statements that were run successfully.
aus_cmd_list	view	Shows information from the aus_command table about UPDATE STATISTICS statements that are scheduled to be run.

For information about other features of the Scheduler, see its description in the *IBM Informix Administrator's Guide*. For information about the **sysadmin** database, see the *IBM Informix Administrator's Reference*.

AUS expiration policies

The Auto Update Statistics (AUS) maintenance system uses expiration policies as criteria for identifying user tables that have changed to the extent that their statistics need to be recalculated.

The **ph_threshold** table of the **sysadmin** database stores the following thresholds for defining AUS expiration policies:

Table 13-2. AUS expiration policy thresholds

Threshold Name	Default Value	Description
AUS_AGE	30 (days)	A time-based expiration policy. Statistics or distributions are updated for a table after this amount of time regardless of how much data has changed.

Table 13-2. AUS expiration policy thresholds (continued)

Threshold Name	Default Value	Description
AUS_AUTO_RULES	1 (enabled)	<p>If enabled, statistics are updated using the higher of the following default minimum guidelines or user-created distribution options:</p> <ul style="list-style-type: none"> • All tables are updated in LOW mode. • All the leading index keys are updated in HIGH mode. • All non-leading index keys are updated in MEDIUM mode. • The minimum resolution for MEDIUM mode is 2.0. • The minimum confidence for MEDIUM mode is 0.95. • The minimum resolution for HIGH mode is 0.5. <p>If the UPDATE STATISTICS statement was run manually for a table, the UPDATE STATISTICS statements generated by the AUS maintenance system do not reduce the level, resolution, confidence, or sampling size options.</p> <p>If disabled, user-created distribution options are used.</p>
AUS_CHANGE	10 (percent)	A modification-based expiration policy. Statistics or distributions are updated for a table after this percentage of data is changed.
AUS_PDQ	10 (priority)	The PDQ priority for UPDATE STATISTICS statements run by the AUS maintenance system. By default, all fragments for each table are analyzed in parallel. For more information about PDQ priority, see “Updating statistics on very large databases” on page 13-17.
AUS_SMALL_TABLES	100 (rows)	Statistics or distributions are updated every time for a table that has fewer than this number of rows.

Changing AUS expiration policies

You can change AUS expiration policies to customize how often statistics are updated based on how old the statistics are, how much data has changed, or how large the table is.

You must be connected to the **sysadmin** database as user **informix** or another authorized user.

To change the value of an expiration policy, update the **value** column in the **ph_threshold** table in the **sysadmin** database.

For example, if you find that queries against small tables with 1000 rows or fewer run faster if their statistics are updated more frequently, you can change the expiration policy to ensure that their statistics are updated every week. The following example changes the value of the `AUS_SMALL_TABLES` threshold to 1000:

```
UPDATE ph_threshold
SET value = 1000
WHERE name = "AUS_SMALL_TABLES";
```

The new threshold takes effect the next time the Auto Update Statistics Evaluator task runs.

Viewing AUS statements

You can view the `UPDATE STATISTICS` statements generated by the AUS maintenance system in the `aus_cmd_list` view before they are run and in the `aus_cmd_comp` view after they are run successfully. Both tables are in the `sysadmin` database.

You must be connected to the `sysadmin` database as user `informix` or another authorized user.

To view all scheduled `UPDATE STATISTICS` statements, run this statement:

```
SELECT * FROM aus_cmd_list;
```

To see all `UPDATE STATISTICS` statements that were run successfully in the previous 30 days, run this statement:

```
SELECT * FROM aus_cmd_comp;
```

To view all `UPDATE STATISTICS` statements that failed, run this statement:

```
SELECT aus_cmd_exe, aus_cmd_err_sql, aus_cmd_err_isam
FROM aus_command
WHERE aus_cmd_state = "E";
```

You can also see this information in the IBM OpenAdmin Tool (OAT) for Informix.

Rescheduling AUS

You can change when and for how long the Auto Update Statistics Refresh task runs.

Updating statistics is resource-intensive. Therefore, by default, statistics are automatically updated on Saturdays and Sundays between 1:00 AM and 5:00 AM. If you find that not all pending `UPDATE STATISTICS` statements can be run in this time period, or you want statistics to be refreshed more often, you can change the start time, the end time, and the days of the week to perform this task.

You must be connected to the `sysadmin` database as user `informix` or another authorized user.

To change the schedule of the Auto Update Statistics Refresh task, update the `ph_task` table where the value of the `fk_name` column is Auto Update Statistics Refresh.

The following example changes the ending time of the task to 6:00 AM:

```
UPDATE ph_task
SET tk_stop_time = "06:00:00"
WHERE tk_name = "Auto Update Statistics Refresh";
```

The following example changes the days that the task is run to every day of the week (Saturday and Sunday are enabled by default):

```
UPDATE ph_task
SET tk_monday = "T",
SET tk_tuesday = "T",
SET tk_wednesday = "T",
SET tk_thursday = "T",
SET tk_friday = "T",
WHERE tk_name = "Auto Update Statistics Refresh";
```

Disabling AUS

You can prevent statistics from being updated automatically by disabling the AUS maintenance system.

You must be connected to the **sysadmin** database as user **informix** or another authorized user.

To disable AUS, you must disable both the Auto Update Statistics Evaluation task and the Auto Update Statistics Refresh task:

1. Update the value of the **tk_enable** column of the **ph_task** table to F where the value of the **tk_name** column is Auto Update Statistics Evaluation.
2. Update the value of the **tk_enable** column of the **ph_task** table to F where the value of the **tk_name** column is Auto Update Statistics Refresh.

The following example disables both tasks:

```
UPDATE ph_task
SET tk_enable = "F"
WHERE tk_name = "Auto Update Statistics Evaluation";
```

```
UPDATE ph_task
SET tk_enable = "F"
WHERE tk_name = "Auto Update Statistics Refresh";
```

Update statistics when they are not generated automatically

The UPDATE STATISTICS statement updates the statistics in the system catalog tables that the optimizer uses to determine the lowest-cost query plan.

Important: You do not need to run UPDATE STATISTICS operations when the statistics are generated automatically.

The following statistics are generated automatically by the CREATE INDEX statement, with or without the ONLINE keyword:

- Index-level statistics, equivalent to the statistics gathered in the UPDATE STATISTICS operation in LOW mode, for B-tree indexes.
- Column-distribution statistics, equivalent to the distribution generated in the UPDATE STATISTICS operation in HIGH mode, for a non-opaque leading indexed column of an ordinary B-tree index.

To ensure that the optimizer selects a query plan that best reflects the current state of your tables, run UPDATE STATISTICS at regular intervals when the statistics are not generated automatically.

Tip: If you run UPDATE STATISTICS LOW on the **sysutils** database before you use ON-Bar, the time ON-BAR needs for processing is reduced.

The following table summarizes when to run different UPDATE STATISTICS statements if the statistics are not generated automatically. If you need to run UPDATE STATISTICS statements and you have many tables, you can write a script to generate these UPDATE STATISTICS statements. ISA can generate many of these UPDATE STATISTICS statements for your tables.

When to Execute	UPDATE STATISTICS Statement	Reference for Details and Examples	ISA Generates Statement
Number of rows has changed significantly	UPDATE STATISTICS LOW DROP DISTRIBUTIONS	"Updating the number of rows" or "Dropping data distributions" on page 13-13	No
For all columns that are not the leading column of any index	UPDATE STATISTICS LOW	"Creating data distributions" on page 13-13	
Queries have non-indexed join columns or filter columns	UPDATE STATISTICS MEDIUM DISTRIBUTIONS ONLY	"Creating data distributions" on page 13-13	Yes
Queries have an indexed join columns or filter columns	UPDATE STATISTICS HIGH table (leading column in index)	"Creating data distributions" on page 13-13	Yes
Queries have a multicolumn indexed defined on join columns or filter columns	UPDATE STATISTICS HIGH table (first differing column in multicolumn index)	"Creating data distributions" on page 13-13	No
Queries have a multicolumn indexed defined on join columns or filter columns	UPDATE STATISTICS LOW table (all columns in multicolumn index)	"Creating data distributions" on page 13-13	No
Queries have many small tables (fit into one extent)	UPDATE STATISTICS HIGH on small tables	"Creating data distributions" on page 13-13	No
Queries use SPL routines	UPDATE STATISTICS for procedure	"Reoptimizing SPL routines" on page 10-31	No

For information about the specific statistics that the database server keeps in the system catalog tables, see "Statistics held for the table and index" on page 10-18.

Related concepts

"Automatic statistics updating" on page 13-6

Updating the number of rows

When you run UPDATE STATISTICS LOW, the database server updates the statistics in the table, row, and page counts in the system catalog tables.

Run UPDATE STATISTICS LOW as often as necessary to ensure that the statistic for the number of rows is as current as possible. If the cardinality of a table changes often, run the statement more often for that table.

LOW is the default mode for UPDATE STATISTICS. The following sample SQL statement updates the statistics in the **sys tables**, **sys columns**, and **sys indexes** system catalog tables but does not update the data distributions:

```
UPDATE STATISTICS FOR TABLE tab1;
```

Dropping data distributions

When you upgrade to a new version of the database server, you might need to drop distributions to remove the old distribution structure in the **sysdistrib** system catalog table.

To drop the old distribution structure in the **sysdistrib** system catalog table, run this statement:

```
UPDATE STATISTICS DROP DISTRIBUTIONS;
```

Dropping distributions in LOW mode without gathering statistics

You can remove distribution information from the **sysdistrib** table and update the **systables.version** column in the system catalog for those tables whose distributions were dropped, without gathering any LOW mode table and index statistics.

You do this using the DROP DISTRIBUTIONS ONLY option in the UPDATE STATISTICS statement. Using the DROP DISTRIBUTIONS ONLY option can result in faster performance because the database server does not gather the table and index statistics that the LOW mode option generates when the ONLY keyword does not follow the DROP DISTRIBUTIONS keywords.

For detailed information about how to use the DROP DISTRIBUTIONS ONLY option, see the *IBM Informix Guide to SQL: Syntax*.

Creating data distributions

The database server creates data distributions, which provide information to the optimizer, any time the UPDATE STATISTICS MEDIUM or UPDATE STATISTICS HIGH command is executed.

(You do not need to run UPDATE STATISTICS operations when the statistics are generated automatically.)

Important:

The database server creates data distributions by sampling a column's data, sorting the data, building distributions bins, and inserting the results into the **sysdistrib** system catalog table.

You can control the sample size for the scan through the keyword HIGH or MEDIUM. The difference between UPDATE STATISTICS HIGH and UPDATE STATISTICS MEDIUM is the number of rows sampled. UPDATE STATISTICS HIGH scans the entire table, while UPDATE STATISTICS MEDIUM samples only a subset of rows, based on the confidence and resolution used by the UPDATE STATISTICS statement.

You can use the LOW keyword with the UPDATE STATISTICS statement only for fully qualified index keys.

If a distribution has been generated for a column, the optimizer uses that information to estimate the number of rows that match a query against a column. Data distributions in **sysdistrib** supersede values in the **colmin** and **colmax** column of the **syscolumns** system catalog table when the optimizer estimates the number of rows returned.

When you use data-distribution statistics for the first time, try to update statistics in MEDIUM mode for all your tables and then update statistics in HIGH mode for

all columns that head indexes. This strategy produces statistical query estimates for the columns that you specify. These estimates, on average, have a margin of error less than *percent* of the total number of rows in the table, where *percent* is the value that you specify in the RESOLUTION clause in the MEDIUM mode. The default percent value for MEDIUM mode is 2.5 percent. (For columns with HIGH mode distributions, the default resolution is 0.5 percent.)

With the DISTRIBUTIONS ONLY option, you can execute UPDATE STATISTICS MEDIUM at the table level or for the entire system because the overhead of the extra columns is not large.

The database server uses the storage locations that the DBSPACETEMP environment variable specifies only when you use the HIGH option of UPDATE STATISTICS.

You can prevent UPDATE STATISTICS operations from using indexes when sorting rows by setting the third parameter of the DBUPSPACE environment variable to a value of 1.

For each table that your query accesses, build data distributions according to the following guidelines. Also see the examples below the guidelines.

To generate statistics on a table:

1. Identify the set of all columns that appear in any single-column or multi-column index on the table.
2. Identify the subset that includes all columns that are not the leading column of any index.
3. Run UPDATE STATISTICS LOW on each column in that subset.

To build data distributions for each table that your query accesses:

1. Run a single UPDATE STATISTICS MEDIUM for all columns in a table that do not head an index.
Use the default parameters unless the table is very large, in which case you should use a resolution of 1.0 and confidence of 0.99.
2. Run the following UPDATE STATISTICS statement to create distributions for non-index join columns and non-index filter columns:
UPDATE STATISTICS MEDIUM DISTRIBUTIONS ONLY;
3. Run UPDATE STATISTICS HIGH for all columns that head an index. For the fastest execution time of the UPDATE STATISTICS statement, you must execute one UPDATE STATISTICS HIGH statement for each column, as shown in the example below this procedure.
4. If you have indexes that begin with the same subset of columns, run UPDATE STATISTICS HIGH for the first column in each index that differs, as shown in the second example below this procedure.
5. For each single-column or multi-column index on the table:
 - a. Identify the set of all columns that appear in the index.
 - b. Identify the subset that includes all columns that are not the leading column of any index.
 - c. Run UPDATE STATISTICS LOW on each column in that subset. (LOW is the default.)
6. For the tables on which indexes were created in Step 3, run an UPDATE STATISTICS statement to update the **sysindexes** and **syscolumns** system catalog tables, as shown in the following example:

```
UPDATE STATISTICS FOR TABLE t1(a,b,e,f);
```

7. For small tables, run UPDATE STATISTICS HIGH, for example:

```
UPDATE STATISTICS HIGH FOR TABLE t2;
```

Because the statement constructs the statistics only once for each index, these steps ensure that UPDATE STATISTICS executes rapidly.

Example of UPDATE STATISTICS HIGH statements for all columns that head an index:

Suppose you have a table **t1** with columns **a**, **b**, **c**, **d**, **e**, and **f** with the following indexes:

```
CREATE INDEX ix_1 ON t1 (a, b, c, d) ...  
CREATE INDEX ix_3 ON t1 (f) ...
```

Run the following UPDATE STATISTICS statements for the columns that head an index:

```
UPDATE STATISTICS HIGH FOR TABLE t1(a);  
UPDATE STATISTICS HIGH FOR TABLE t1(f);
```

These UPDATE STATISTICS HIGH statements replace the distributions created with the UPDATE STATISTICS MEDIUM statements with high distributions for index columns.

Example of UPDATE STATISTICS HIGH statements for the first column in each index that differs:

For example, suppose you have the following indexes on table **t1**:

```
CREATE INDEX ix_1 ON t1 (a, b, c, d) ...  
CREATE INDEX ix_2 ON t1 (a, b, e, f) ...  
CREATE INDEX ix_3 ON t1 (f) ...
```

Step 3 on page 13-14 executes UPDATE STATISTICS HIGH on column **a** and column **f**. Then run UPDATE STATISTICS HIGH on columns **c** and **e**.

```
UPDATE STATISTICS HIGH FOR TABLE t1(c);  
UPDATE STATISTICS HIGH FOR TABLE t1(e);
```

In addition, you can run UPDATE STATISTICS HIGH on column **b**, although this is usually not necessary.

Suppose you have indexes that begin with the same subset of columns, but contain some columns that differ. For additional information about data distributions and the UPDATE STATISTICS statement, see the *IBM Informix Guide to SQL: Syntax*.

Updating statistics for join columns

In some situations, you might want to run the UPDATE STATISTICS statement with the HIGH keyword for specific join columns.

Because of improvements and adjusted cost estimates to establish better query plans, the optimizer depends greatly on an accurate understanding of the underlying data distributions in certain cases. You might still think that a complex query does not execute quickly enough, even though you followed the guidelines in “Creating data distributions” on page 13-13. If your query involves equality predicates, take one of the following actions:

- Run the UPDATE STATISTICS statement with the HIGH keyword for specific join columns that appear in the WHERE clause of the query. If you followed the guidelines in “Creating data distributions” on page 13-13, columns that head indexes already have HIGH mode distributions.
- Determine whether HIGH mode distribution information about columns that do not head indexes can provide a better execution path, take the following steps:

To determine if UPDATE STATISTICS HIGH on join columns might make a difference:

1. Issue the SET EXPLAIN ON statement and rerun the query.
2. Note the estimated number of rows in the SET EXPLAIN output and the actual number of rows that the query returns.
3. If these two numbers are significantly different, run UPDATE STATISTICS HIGH on the columns that participate in joins, unless you have already done so.

Important: If your table is very large, UPDATE STATISTICS with the HIGH mode can take a long time to execute.

The following example shows a query that involves join columns:

```
SELECT employee.name, address.city
FROM employee, address
WHERE employee.ssn = address.ssn
AND employee.name = 'James'
```

In this example, the join columns are the **ssn** fields in the **employee** and **address** tables. The data distributions for both of these columns must accurately reflect the actual data so that the optimizer can correctly determine the best join plan and execution order.

You cannot use the UPDATE STATISTICS statement to create data distributions for a table that is external to the current database. For additional information about data distributions and the UPDATE STATISTICS statement, see the *IBM Informix Guide to SQL: Syntax*.

Updating statistics for columns with user-defined data types

Programmers can write functions that gather statistics for columns with user-defined data types. You can store the data distributions for user-defined data types in an sbspace.

Because information about the nature and use of a user-defined data type (UDT) is not available to the database server, it cannot collect the **colmin** and **colmax** column of the **syscolumns** system catalog table for user-defined data types. To gather statistics for columns with user-defined data types, programmers must write functions that extend the UPDATE STATISTICS statement. For more information, see the performance chapter in *IBM Informix User-Defined Routines and Data Types Developer's Guide*.

Because the data distributions for user-defined data types can be large, you can optionally store them in an sbspace instead of the **sysdistrib** system catalog table.

To store data distributions for user-defined data types in an sbspace:

1. Use the **onspaces -c -S** command to create an sbspace.

To ensure recoverability of the data distributions, specify `LOGGING=ON` in the `-Df` option, as the following sample shows:

```
% onspaces -c -S distrib_sbsp -p /dev/raw_dev1 -o 500 -s
20000
-m /dev/raw_dev2 500 -Ms 150 -Mo 200 -Df
"AVG_LO_SIZE=32,LOGGING=ON"
```

For information on sizing an sbspace, see “Estimating pages that smart large objects occupy” on page 6-10.

For more information about specifying storage characteristics for sbspaces, see “Configuration parameters that affect sbspace I/O” on page 5-20.

2. Specify the sbspace that you created in step 1 in the configuration parameter `SYSSBSPACENAME`.
3. Specify the column with the user-defined data type when you run the `UPDATE STATISTICS` statement with the `MEDIUM` or `HIGH` keywords to generate data distributions.

To print the data distributions for a column with a user-defined data type, use the `dbschema -hd` option.

Updating statistics on very large databases

If you have an extremely large database and indexes are fragmented, `UPDATE STATISTICS LOW` can automatically run statements in parallel.

To enable statements to automatically run in parallel, you must run `UPDATE STATISTICS LOW` with the PDQ priority set to a value that is between 1 and 10. If the PDQ priority is set to 1, 10 percent of the index fragments are analyzed at one time for the current table. If the PDQ priority is set to 5, 50 percent of the index fragments are analyzed at one time for the current table. If the PDQ priority is set to 10, all fragments are analyzed at one time for the current table. (If the PDQ priority is set to a value that is higher than 10, Informix operates as if the PDQ priority is set to 10, analyzing all fragments at one time for the current table.)

If you run `UPDATE STATISTICS MEDIUM` or `HIGH`, you can set the PDQ priority to a value that is higher than 10. Because the `UPDATE STATISTICS MEDIUM` and `HIGH` statements perform a large amount of sorting operations, increasing the PDQ priority to a value that is higher than 10 provides additional memory than can improve the speed of the sorting operations.

Displaying data distributions

You can use the `dbschema` utility to display data distributions.

Unless column values change considerably, you do not need to regenerate the data distributions. To verify the accuracy of the distribution, compare `dbschema -hd` output with the results of appropriately constructed `SELECT` statements.

For example, the following `dbschema` command produces a list of distributions for each column of table `customer` in database `vjp_stores` with the number of values in each bin, and the number of distinct values:

```
dbschema -hd customer -d vjp_stores
```

Figure 13-4 on page 13-18 shows the data distributions for the column `zipcode` that this `dbschema -hd` command produces. Because this column heads the `zip_ix` index, `UPDATE STATISTICS HIGH` was run on it, as the following output line indicates:

High Mode, 0.500000 Resolution

Figure 13-4 shows 17 bins with one distinct **zipcode** value in each bin.

```
dbschema -hd customer -d vjp_stores
...
Distribution for virginia.customer.zipcode
Constructed on 09/18/2000
High Mode, 0.500000 Resolution
--- DISTRIBUTION ---
      (          02135 )
1: ( 1, 1, 02135 )
2: ( 1, 1, 08002 )
3: ( 1, 1, 08540 )
4: ( 1, 1, 19898 )
5: ( 1, 1, 32256 )
6: ( 1, 1, 60406 )
7: ( 1, 1, 74006 )
8: ( 1, 1, 80219 )
9: ( 1, 1, 85008 )
10: ( 1, 1, 85016 )
11: ( 1, 1, 94026 )
12: ( 1, 1, 94040 )
13: ( 1, 1, 94085 )
14: ( 1, 1, 94117 )
15: ( 1, 1, 94303 )
16: ( 1, 1, 94304 )
17: ( 1, 1, 94609 )

--- OVERFLOW ---
1: ( 2, 94022 )
2: ( 2, 94025 )
3: ( 2, 94062 )
4: ( 3, 94063 )
5: ( 2, 94086 )
```

Figure 13-4. Displaying Data Distributions with `dbschema -hd`

The OVERFLOW portion of the output shows the duplicate values that might skew the distribution data, so **dbschema** moves them from the distribution to a separate list. The number of duplicates in this overflow list must be greater than a critical amount that the following formula determines. Figure 13-4 shows a resolution value of .0050. Therefore, this formula determines that any value that is duplicated more than one time is listed in the overflow section.

$$\begin{aligned} \text{Overflow} &= .25 * \text{resolution} * \text{number_rows} \\ &= .25 * .0050 * 28 \\ &= .035 \end{aligned}$$

For more information about the **dbschema** utility, see the *IBM Informix Migration Guide*.

Improving the performance of UPDATE STATISTICS

When you execute the UPDATE STATISTICS statement, the database server uses memory and disk to sort and construct data distributions. You can affect the amount of memory and disk space available for UPDATE STATISTICS.

You can affect the amount of memory and disk space available for UPDATE STATISTICS with the following methods:

- PDQ priority

You can obtain more memory for sorting when you set PDQ priority greater than 0. The default value for PDQ priority is 0. To set PDQ priority, use either the **PDQPRIORITY** environment variable or the SQL statement SET PDQPRIORITY.

For more information about PDQ priority, see “The allocation of resources for parallel database queries” on page 12-7.

- **DBUPSPACE** environment variable

You can use the **DBUPSPACE** environment variable to constrain the amount of system disk space that the UPDATE STATISTICS statement can use to construct multiple column distributions simultaneously.

For more information about this environment variable, see the *IBM Informix Guide to SQL: Reference*.

Improve performance by adding or removing indexes

You can often improve the performance of a query by adding or, in some cases, removing indexes. You can also enable the optimizer to automatically fetch a set of keys from an index buffer.

To improve the performance of a query, consider using some of the methods that the following topics describe.

In addition, consider using the CREATE INDEX ONLINE and DROP INDEX ONLINE statements to create and drop an index in an online environment, when the database and its associated tables are continuously available. These SQL statements enable you to create and drop indexes without having an access lock placed over the table during the duration of the index builds or drops. For more information, see “Creating and dropping an index in an online environment” on page 7-11.

Replace autoindexes with permanent indexes

If the query plan includes an *autoindex* path to a large table, you can generally improve performance by adding an index on that column. If you perform a query regularly, you can save time by creating a permanent index.

If you perform the query occasionally, you can reasonably let the database server build and discard an index.

Use composite indexes

The optimizer can use a composite index (one that covers more than one column) in several ways.

The database server can use an index on columns **a**, **b**, and **c** (in that order) in the following ways:

- To locate a particular row

The database server can use a composite index when the first filter is an equality filter and subsequent columns have range (<, <=, >, >=) expressions. The following examples of filters use the columns in a composite index:

```
WHERE a=1
WHERE a>=12 AND a<15
WHERE a=1 AND b < 5
WHERE a=1 AND b = 17 AND c >= 40
```

The following examples of filters cannot use that composite index:

```
WHERE b=10
WHERE c=221
WHERE a>=12 AND b=15
```

- To replace a table scan when all of the desired columns are contained within the index

A scan that uses the index but does not reference the table is called a *key-only search*.

- To join column **a**, columns **ab**, or columns **abc** to another table
- To implement ORDER BY or GROUP BY on columns **a**, **ab**, or **abc** but not on **b**, **c**, **ac**, or **bc**

Execution is most efficient when you create a composite index with the columns in order from most to least distinct. In other words, the column that returns the highest count of distinct rows when queried with the DISTINCT keyword in the SELECT statement should come first in the composite index.

If your application performs several long queries, each of which contains ORDER BY or GROUP BY clauses, you can sometimes improve performance by adding indexes that produce these orderings without requiring a sort. For example, the following query sorts each column in the ORDER BY clause in a different direction:

```
SELECT * FROM t1 ORDER BY a, b DESC;
```

To avoid using temporary tables to sort column **a** in ascending order and column **b** in descending order, you must create a composite index on (**a**, **b** DESC) or on (**a** DESC, **b**). You need to create only one of these indexes because of the bidirectional-traverse capability of the database server. For more information about bidirectional traverse, see the *IBM Informix Guide to SQL: Syntax*.

On the other hand, it can be less expensive to perform a table scan and sort the results instead of using the composite index when the following criteria are met:

- Your table is well ordered relative to your index.
- The number of rows that the query retrieves represents a large percentage of the available data.

Indexes for data warehouse applications

Many data warehouse databases use a *star schema*, which consists of a *fact* table and a number of *dimensional* tables. Queries that use tables in a star schema or snowflake schema can benefit from the proper index on the fact table.

The fact table is generally large and contains the quantitative or factual information about the subject. A dimensional table describes an attribute in the fact table.

When a dimension needs lower-level information, the dimension is modeled by a hierarchy of tables, called a *snowflake schema*.

Consider the example of a star schema with one fact table named **orders** and four dimensional tables named **customers**, **suppliers**, **products**, and **clerks**. The **orders** table describes the details of each sale order, which includes the customer ID, supplier ID, product ID, and sales clerk ID. Each dimensional table describes an ID in detail. The **orders** table is large, and the four dimensional tables are small.

The following query finds the total direct sales revenue in the Menlo Park region (postal code 94025) for hard drives supplied by the Johnson supplier:

```
SELECT sum(orders.price)
FROM orders, customers, suppliers, product, clerks
WHERE orders.custid = customers.custid
      AND customers.zipcode = 94025
      AND orders.suppid = suppliers.suppid
      AND suppliers.name = 'Johnson'
      AND orders.prodid = product.prodid
      AND product.type = 'hard drive'
      AND orders.clerkid = clerks.clerkid
      AND clerks.dept = 'Direct Sales'
```

This query uses a typical star join, in which the fact table joins with all dimensional tables on a foreign key. Each dimensional table has a selective table filter.

An optimal plan for the star join is to perform a cartesian product on the four dimensional tables and then join the result with the fact table. The following index on the fact table allows the optimizer to choose the optimal query plan:

```
CREATE INDEX ON orders(custid,suppid,prodid,clerkid)
```

Without this index, the optimizer might choose to first join the fact table with a single dimensional table and then join the result with the remaining dimensional tables. The optimal plan provides better performance.

For more information about star schemas and snowflake schemas, see the *IBM Informix Database Design and Implementation Guide*.

Configure B-tree scanner information to improve transaction processing

You can improve the performance of transaction processing in logged databases by controlling how the B-tree scanner threads remove deletions from indexes.

The B-tree scanner improves transaction processing for logged databases when rows are deleted from a table with indexes. The B-tree scanner automatically determines which index partitions will be cleaned, based on a priority list. B-tree scanner threads remove deleted index entries and rebalance the index nodes. The B-tree scanner automatically determines which index items are to be deleted.

In a logged database, when a delete or an update operation is performed on a row, any corresponding index entry is not immediately deleted. Instead, the corresponding index entry is flagged as deleted until a B-tree scanner thread scans the index and removes the deleted items. An index containing many deleted items can cause a significant performance problem, because index searches need to scan a larger number of items before finding the first valid item.

The default setting for B-tree scanning provides the following type of scanning, depending on your indexes:

- If the table has more than one attached index, the B-tree scanner uses the leaf scan mode. Leaf scan mode is the only type of scanning possible with multiple attached indexes.
- If the table contains a single attached index or if the indexes are detached, the B-tree scanner uses alic (adaptive linear index cleaning) mode. The initial alic scan mode is optimized for small- to medium-sized systems with few or no indexes above 1 GB. However, if the database server detects that the alic mode is inefficient, the alic scan mode setting is adjusted automatically to accommodate larger indexes.

Depending on your application and the order in which the system adds and deletes keys from the index, the structure of an index can become inefficient.

You use the BTSCANNER configuration parameter to specify the following information, which defines the scan mode:

- The number of B-tree scanner threads to start when the database server starts
The number of B-tree scanner threads is configurable to any positive number. One B-tree scanner thread will always clean an individual index partition, so if you occasionally or consistently have a higher number of index partitions requiring cleaning, you might want to use more than one B-tree scanner thread. At runtime, you can turn off any B-tree scanner activity by issuing an **onmode -C** command. This command stops all B-tree scanner threads.
- The threshold, which is the minimum number of deleted items an index must encounter before an index is placed on the priority list for eligibility for scanning and cleaning by a B-tree scanner thread
For example, if you increase the threshold beyond 5000, you might be able to avoid frequent B-tree scanner activity on the indexes that receive the most updates and deletes.
- The range size, in kilobytes, that an index or index fragment must exceed before the index is cleaned with range scanning
- An alic mode value
- The level at which B-tree scanner threads compress indexes by merging two partially used index pages

The following table summarizes the differences between the scan modes.

Table 13-3. Scan modes for B-tree scanner threads

Scan Mode	Description	Performance Advantages or Issues	More Information
Leaf scan mode	In this mode, the leaf level of an attached index is completely scanned for deleted items.	This mode is only possible on attached indexes and is the only mode the server can use if more than one attached index exists in a partition.	"Leaf and range scan mode settings" on page 13-26

Table 13-3. Scan modes for B-tree scanner threads (continued)

Scan Mode	Description	Performance Advantages or Issues	More Information
<p>Alice (adaptive linear index cleaning) scan mode</p>	<p>If the BTSCANNER alice option is enabled, every index partition receives a bitmap that tracks where a deleted item was found in the index. The scan that occurs excludes all parts of the index where no delete operations are found.</p> <p>The initial size and granularity of these bitmaps depend on the size of the partitions they represent and the current system-wide alice level. The server periodically checks each bitmap for its efficiency by checking the ratio of pages to be cleaned to pages read, adjusting scanning if necessary to get better information. This mode allocates additional resources (memory) to the index that is consuming excess I/O.</p>	<p>You can greatly improve performance and reduce I/O when using the alice mode. Generally, alice mode is 64 times more efficient than range scanning and can automatically tune itself for unsatisfactory indexes, which range scanning cannot do.</p>	<p>“Alice scan mode values” on page 13-24</p>

Table 13-3. Scan modes for B-tree scanner threads (continued)

Scan Mode	Description	Performance Advantages or Issues	More Information
Range scan mode	Range scanning, which is enabled with the <code>rangesize</code> option, is performed in the range between the low and high page address. The leaf level of the index partition is only scanned within this range. The server performs light scans, which do not immediately use and strain the buffer pool, even though cleaning occurs through the buffer pool.	Not recommended for Informix Version 11.10 or higher. Alice scanning is exactly the same as range scanning, but is 64 times more efficient, uses the same resources, and has 128 equal ranges. When you set <code>alice</code> mode scanning, range scanning does not have an effect. If you decide to use range scanning for systems with only a lot of large indexes, set the <code>rangesize</code> option to the minimum partition size for range scanning.	"Leaf and range scan mode settings" on page 13-26

For more information about the `BTSCANNER` configuration parameter and for more information about how the database server maintains an index tree, see the chapter on configuration parameters and the chapter on disk structure and storage in the *IBM Informix Administrator's Reference*.

Use the `onstat -C` option to monitor the B-tree scanner activities.

Use the `onmode -C` option to change the configuration of B-tree scanners during runtime.

For more information about `onstat -C` and `onmode -C`, see the *IBM Informix Administrator's Reference*.

Alice scan mode values

You enable `alice` (adaptive linear index cleaning) mode by setting the `alice` option to any value between 1 and 12 (finest initial granularity). For small- to medium-sized systems with few or no indexes above 1 gigabyte, set the `alice` option to 6 or 7. For systems with large indexes, set `alice` to a higher mode.

When you set `alice` mode, the higher the mode, the more memory is used per index partition. However, the memory used is not a huge amount. The advantage is less I/O, as shown in the following table.

Table 13-4. Alice mode settings

Alice Mode Setting	Memory or Block I/O
0	Turns off <code>alice</code> scanning.
1	Uses exactly 8 bytes of memory (no adjusting).

Table 13-4. Alice mode settings (continued)

Alice Mode Setting	Memory or Block I/O
2	Uses exactly 16 bytes of memory (no adjusting).
3	Each block of pages will need 512 I/O operations for cleaning.
4	Each block of pages will need 256 I/O operations for cleaning.
5	Each block of pages will need 128 I/O operations for cleaning.
6 (default)	Each block of pages will need 64 I/O operations for cleaning.
7	Each block of pages will need 32 I/O operations for cleaning.
8	Each block of pages will need 16 I/O operations for cleaning.
9	Each block of pages will need 8 I/O operations for cleaning.
10	Each block of pages will need 4 I/O operations for cleaning.
11	Each block of pages will need 2 I/O operations for cleaning.
12	Each block of pages will need 1 I/O operations for cleaning.

When you set the alice mode, you need to consider memory usage versus I/O. The lower the alice mode setting, the less memory the index will use. The higher the alice mode setting, the more memory the index will use. 12 is the highest mode value, because it is a direct mapping of a single bit of memory to each instance of I/O.

Suppose you have an online page size of 2 KB and the default B-Tree Scanner I/O size of 256 pages. If you set the alice mode to 6, each byte of memory can represent 131,072 index pages (256 MB). If you set the mode to 10, each byte of memory can represent 8,192 index pages (16 MB). Thus, changing the mode setting from 6 to 10 requests 16 times the memory, but requires 16 times less I/O.

If you have an index partition that uses 1 GB, then an alice mode setting of 6 would take 4 bytes of memory, while an alice mode setting of 10 would consume 64 bytes of memory, as shown in this formula:

$$(\{ \text{mode block size} \} \text{ io per bit } * 8 \text{ bits per byte } * 256 \text{ page per io })$$

Setting the alice mode to a value between 3 and 12 sets the initial amount of memory that is used for index cleaning. Subsequently, the B-tree scanners automatically adjust the mode based on the efficiency of past cleaning operations.

For example, if after five scans (by default), the I/O efficiency is below 75 percent, the server automatically adjusts to the next alice mode if you set the mode to a value above 2. For example, if an index is currently operating in alice mode 6, a B-tree scanner has cleaned the index at least 5 times, and the I/O efficiency is below 75 percent, the server automatically adjusts to mode 7, the next higher mode. This doubles the memory required, but reduces the I/O by a factor of 2.

The server will re-evaluate the index after five more scans to determine the I/O efficiency again, and will continue to do this until mode 12. The server stops making adjustments at mode 12.

The following example sets the alice mode to 6:

```
BTSCANNER num=2,threshold=10000,alice=6,compression=default
```

Leaf and range scan mode settings

If a table has more than one attached index, the B-tree scanner uses the leaf scan mode. If you want small indexes to be scanned by the leaf scan method, set the `rangesize` option of the BTSCANNER configuration parameter to 100.

If you decide to enable range scan mode when a single index exists in the partition, set `rangesize` option of the BTSCANNER configuration parameter to the minimum size that a partition must have to be scanned using this mode. Specify the size in kilobytes.

The following example specifies that:

- The server will start two B-tree scanner threads.
- The server will consider cleaning indexes in the hot list (a list of indexes that caused the server to do extra work) when 50000 deleted items are found in the index.
- Indexes with a partition size that is equal to or larger than 100 KB will be cleaned using the range scan mode.
- Indexes with a partition size of less than 100 KB will be cleaned using the leaf scan mode.
- Index compression is set at the medium (default) level

```
BTSCANNER num=2,threshold=50000,rangesize=100,compression=default
```

B-tree scanner index compression levels and transaction processing performance

B-tree scanner threads compress indexes by merging two partially used index pages if the amount of data on those pages is below the level that is specified by the compression option. You can set the compression level to control the amount of I/O required to find and load data.

B-tree scanner threads look for index pages that can be compressed because they are below the specified level. The B-tree scanner can compress index pages with deleted items and pages that do not have deleted items.

By default, a B-tree scanner compresses at the medium level. The following table provides information about the performance benefits and trade-offs if you change the compression level to high or low.

Table 13-5. B-Tree Scanner Compression Level Benefits and Trade-offs

Compression Level	Performance Benefits and Trade-offs	When to Use
Low	The low compression level is beneficial for an index that is expected to grow quickly, with frequent B-tree node splits. When the compression level is set to low, the B-tree index will not require as many splits as indexes with medium or high compression levels, because more free space remains in the B-tree nodes.	You might want to change the compression level to low if you expect an index to grow quickly with frequent splits.

Table 13-5. B-Tree Scanner Compression Level Benefits and Trade-offs (continued)

Compression Level	Performance Benefits and Trade-offs	When to Use
High	<p>In general, if an index is read-only or 90 percent of it is read-only, the high compression level is beneficial because searching for data will require fewer pages (and less I/O) to traverse. Examples might be indexes that do not have frequent changes or indexes undergoing batch (block) delete operations.</p> <p>Using high level of compression also means a performance trade-off, because it takes more I/O to compress the index more aggressively. Select operations will have less I/O when the compression level is high.</p>	<p>You might want to change the compression level to high under these circumstances:</p> <ul style="list-style-type: none"> • If an index is read most of the time, and delete and insert operations occur a small percentage of the time. • If tables are loaded and updated in a batch and are kept for a period of time as read-only tables.

If you do not need to change the compression level to high or low, set the compression option of the BTSCANNER configuration parameter to med or default.

Index Compression and the Index Fill Factor

In addition to the compression option that specifies when to attempt to join two partially used pages, you can use the FILL FACTOR configuration parameter to control when to add new index pages. The index fill factor, which you define with the FILLFACTOR configuration parameter or the FILLFACTOR option of the CREATE INDEX statement, is a percentage of each index page that will be filled during the index build.

Setting the level for B-tree scanner compression of indexes

Informix provides several ways to specify the level at which B-tree scanner threads will compress indexes pages. To optimize space and transaction processing, you can lower the compression level if your indexes grow quickly. You can increase the level if your indexes have few delete and insert operations or if batch updates are performed.

Prerequisites:

- Determine if adjusting the level for index compression will improve performance.
- Get statistics on the number of rows read, deleted, and inserted by running the **onstat -g ppf** command. You can also view information in the **sysptprof** table.
- Analyze the statistics to determine if you want to change the threshold.

For information about compression levels and the circumstances under which you might want to change the level, see “B-tree scanner index compression levels and transaction processing performance” on page 13-26.

Specify the compression level for an instance with any of the following options:

- Set the compression field of the BTSCANNER configuration parameter to low, med (medium), high, or default. (The system default value is med.)

- Run the **onmode -C compression value** command, where *value* is low, med (medium), high, and default. The system default value is med.
- Run an SQL administration API function with this command:
SET INDEX COMPRESSION, *partition number*, *compression level*

Examples:

Set the compression option of the BTSCANNER configuration parameter to default as follows:

```
BTSCANNER num=4,threshold=10000,range=-1,alice=6,compression=default
```

Set the compression option of the BTSCANNER configuration parameter to high as follows:

```
BTSCANNER num=4,threshold=5000,compression=high
```

Specify the compression level using **onmode -C**, as follows:

```
onmode -C compression high
```

Run either of the following SQL administration API functions to set the compression level for a single fragment of the index that has the partition number 1048960:

```
EXECUTE FUNCTION TASK("SET INDEX COMPRESSION", 1048960, "DEFAULT");  
EXECUTE FUNCTION ADMIN("SET INDEX COMPRESSION", 1048960, "LOW");
```

Run the following SELECT statement to execute the task function over all index fragments. This command sets the compression level for all fragments of an index named *idx1* in a database named *db1*.

```
SELECT sysadmin:TASK("SET INDEX COMPRESSION", partnum, "MED")  
FROM sysmaster:systabnames  
WHERE dbsname = 'db1' AND tabname = 'idx1';
```

You can also run the following SELECT TASK statement to execute the task function over all index fragments and set the compression level for all fragments.

```
SELECT TASK("SET INDEX COMPRESSION", partn, "MED")  
FROM db1:systables t, db1:sysfragments f  
WHERE f.tabid = t.tabid AND f.fragtype = 'I' AND indexname = 'idx1';
```

Determine the amount of free space in an index page

You can use the **oncheck -pT** command to determine the amount of free space in each index page.

If your table has relatively low update activity and a large amount of free space exists, you might want to drop and re-create the index with a larger value for **FILLFACTOR** to make the unused disk space available.

Optimizer estimates of distributed queries

The optimizer assumes that access to a row from a remote database takes longer than access to a row in a local database. The optimizer estimates include the cost of retrieving the row from disk and transmitting it across the network.

For an example of this higher estimated cost, see “The query plan of a distributed query” on page 13-29.

Buffer data transfers for a distributed query

Informix uses several factors to determine the size of the buffer that sends and receives data to and from a remote server.

The server uses the following factors to determine the buffer size:

- The row size

The database server calculates the row size by summing the average move size (if available) or the length (from the `syscolumns` system catalog table) of the columns.

- The setting of the `FET_BUF_SIZE` environment variable on the client

You might be able to reduce the size and number of data transfers by using the `FET_BUF_SIZE` environment variable to increase the size of the buffer that the database server uses to send and receive rows to and from the remote database server.

The minimum buffer size is 1024 or 2048 bytes, depending on the row size. If the row size is larger than either 1024 or 2048 bytes, the database server uses the `FET_BUF_SIZE` value.

For more information about the `FET_BUF_SIZE` environment variable, see the *IBM Informix Guide to SQL: Reference*.

The query plan of a distributed query

You can display the chosen query plan of a distributed query. The information displayed for a distributed join differs from information displayed for a local join.

The following figure shows the chosen query plan for the distributed query.

```
QUERY:
-----
select l.customer_num, l.lname, l.company,
       l.phone, r.call_dtime, r.call_descr
  from customer l, vjp_stores@gilroy:cust_calls r
 where l.customer_num = r.customer_num

Estimated Cost: 9
Estimated # of Rows Returned: 7

  1) informix.r: REMOTE PATH

  2) informix.l: INDEX PATH

      (1) Index Keys: customer_num (Serial, fragments: ALL)
          Lower Index Filter: informix.l.customer_num = informix.r.customer_num
NESTED LOOP JOIN
```

Figure 13-5. Selected Output of SET EXPLAIN ALL for Distributed Query, Part 3

The following table shows the main differences between the chosen query plans for the distributed join and the local join.

Output Line in Figure 13-5 for Distributed Query	Output Line in Figure 11-3 on page 11-10 for Local-Only Query	Description of Difference
vjp_stores@gilroy: virginia.cust_calls	informix.cust_calls	The remote table name is prefaced with the database and server names.

Output Line in Figure 13-5 on page 13-29 for Distributed Query	Output Line in Figure 11-3 on page 11-10 for Local-Only Query	Description of Difference
Estimated Cost: 9	Estimated Cost: 7	The optimizer estimates a higher cost for the distributed query.
informix.r: REMOTE PATH	informix.r: SEQUENTIAL SCAN	The optimizer chose to keep the outer, remote <code>cust_calls</code> table at the remote site.
select x0.call_dtime,x0.call_descr,x0.customer_num from vjp_stores:"virginia".cust_calls x0		The SQL statement that the local database server sends to the remote site. The remote site reoptimizes this statement to choose the actual plan.

Improve sequential scans

You can improve the performance of sequential read operations on large tables by eliminating repeated sequential scans.

Sequential access to a table other than the first table in the plan is ominous because it threatens to read every row of the table once for every row selected from the preceding tables.

If the table is small, it is harmless to read it repeatedly because the table resides completely in memory. Sequential search of an in-memory table can be faster than searching the same table through an index, especially if maintaining those index pages in memory pushes other useful pages out of the buffers.

When the table is larger than a few pages, however, repeated sequential access produces poor performance. One way to prevent this problem is to provide an index to the column that is used to join the table.

Any user with the Resource privilege can build additional indexes. Use the `CREATE INDEX` statement to make an index.

An index consumes disk space proportional to the width of the key values and the number of rows. (See “Estimating index pages” on page 7-3.) Also, the database server must update the index whenever rows are inserted, deleted, or updated; the index update slows these operations. If necessary, you can use the `DROP INDEX` statement to release the index after a series of queries, which frees space and makes table updates easier.

Enable view folding to improve query performance

You can significantly improve the performance of a query that involves a view by enabling view folding.

You do this by setting the `IFX_FOLDVIEW` configuration parameter to 1.

When view folding is enabled, views are folded into a parent query. Because the views are folded into the parent query, the query results are not placed in a temporary table.

You can use view folding in the following types of queries:

- Views that contain a UNION ALL clause and the parent query has a regular join, an Informix join, an ANSI join, or an ORDER BY clause

View folding does not occur for the following types of queries that perform a UNION ALL operation involving a view:

- The view has one of the following clauses: AGGREGATE, GROUP BY, ORDER BY, UNION, DISTINCT, or OUTER JOIN (either Informix or ANSI type).
- The parent query has a UNION or UNION ALL clause.

In these situations, a temporary table is created to hold query results.

Reduce the join and sort operations

After you understand what the query is doing, you can look for ways to obtain the same output with less effort.

The following suggestions can help you rewrite your query more efficiently:

- Avoid or simplify sort operations.
- Use parallel sorts.
- Use temporary tables to reduce sorting scope.

Avoid or simplify sort operations

In many situations you can determine how to avoid or reduce frequent or complex sort operations.

The sort algorithm is highly tuned and extremely efficient. It is as fast as any external sort program that you might apply to the same data. You do not need to avoid infrequent sorts or sorts of relatively small numbers of output rows.

However, you should try to avoid or reduce the scope of repeated sorts of large tables. The optimizer avoids a sort step whenever it can use an index to produce the output in its proper order automatically. The following factors prevent the optimizer from using an index:

- One or more of the ordered columns is not included in the index.
- The columns are named in a different sequence in the index and the ORDER BY or GROUP BY clause.
- The ordered columns are taken from different tables.

For another way to avoid sorts, see “Use temporary tables to reduce sorting scope” on page 13-32.

If a sort is necessary, look for ways to simplify it. As discussed in “Sort-time costs” on page 10-22, the sort is quicker if you can sort on fewer or narrower columns.

Related concepts

“Ordering with fragmented indexes” on page 13-36

Use parallel sorts

When you cannot avoid sorting, the database server takes advantage of multiple CPU resources to perform the required sort-and-merge operations in parallel. The database server can use parallel sorts for any query, not just PDQ queries. You can control the number of threads that the database server uses to sort rows.

To control the number of threads that the database server uses to sort rows, use the **PSORT_NPROCS** environment variable.

When PDQ priority is greater than 0 and **PSORT_NPROCS** is greater than 1, the query benefits both from parallel sorts and from PDQ features such as parallel scans and additional memory. Users can use the **PDQPRIORITY** environment variable to request a specific proportion of PDQ resources for a query. You can use the **MAX_PDQPRIORITY** configuration parameter to limit the number of such user requests. For more information, see “Limiting PDQ resources in queries” on page 3-11.

In some cases, the amount of data being sorted can overflow the memory resources allocated to the query, resulting in I/O to a dbspace or sort file. For more information, see “Configure dbspaces for temporary tables and sort files” on page 5-8.

Use temporary tables to reduce sorting scope

You can use a temporary, ordered subset of a table to increase the speed of a query. The temporary table can also simplify the work of the query optimizer, cause the optimizer to avoid multiple-sort operations, and simplify the work of the optimizer in other ways.

For example, suppose your application produces a series of reports on customers who have outstanding balances, one report for each major postal area, ordered by customer name. In other words, a series of queries occurs, each of the following form (using hypothetical table and column names):

```
SELECT cust.name, rcvbles.balance, ...other columns...
FROM cust, rcvbles
WHERE cust.customer_id = rcvbles.customer_id
      AND rcvbles.balance > 0
      AND cust.postcode LIKE '98_ _ _'
ORDER BY cust.name
```

This query reads the entire **cust** table. For every row with the specified postal code, the database server searches the index on **rcvbles.customer_id** and performs a nonsequential disk access for every match. The rows are written to a temporary file and sorted. For more information about temporary files, see “Configure dbspaces for temporary tables and sort files” on page 5-8.

This procedure is acceptable if the query is performed only once, but this example includes a series of queries, each incurring the same amount of work.

An alternative is to select all customers with outstanding balances into a temporary table, ordered by customer name, as the following example shows:

```
SELECT cust.name, rcvbles.balance, ...other columns...
FROM cust, rcvbles
WHERE cust.customer_id = rcvbles.customer_id
      AND cvb1s.balance > 0
INTO TEMP cust_with_balance
```

You can then execute queries against the temporary table, as the following example shows:

```
SELECT *
FROM cust_with_balance
WHERE postcode LIKE '98_ _ _'
ORDER BY cust.name
```

Each query reads the temporary table sequentially, but the table has fewer rows than the primary table.

More memory for queries with hash joins, aggregates, and other memory-intensive elements

You can increase the amount of memory that is available for a query that is not a Parallel Database Query (PDQ).

If you want to increase the amount of memory that is available for a query that is not a PDQ query and the PDQ priority is set to 0 (zero), you can change the amount by changing value of the DS_NONPDQ_QUERY_MEM configuration parameter.

You can also change the value of DS_NONPDQ_QUERY_MEM with one the following other options:

- The **onmode -wm** or **onmode -wf** commands
- The **Non PDQ Query Memory** option on the ON-Monitor **pdQ** menu

For example, if you use the onmode utility, specify a value as shown in the following example:

```
onmode -wf DS_NONPDQ_QUERY_MEM=500
```

The minimum value for DS_NONPDQ_QUERY_MEM is 128 kilobytes. The maximum supported value is 25 percent of DS_TOTAL_MEMORY. 128 kilobytes is the default value of DS_NONPDQ_QUERY_MEM. If you specify a value for the DS_NONPDQ_QUERY_MEM parameter, determine and adjust the value based on the number and size of table rows involved in the query.

Informix might recalculate the value of DS_NONPDQ_QUERY_MEM initialization if the value is more than 25 percent of the DS_TOTAL_MEMORY value.

If Informix changes the value that you set, the server sends a message in this format:

```
DS_NONPDQ_QUERY_MEM recalculated and changed from old_value Kb to new_value Kb.
```

In the message, *old_value* represents the value that you assigned to DS_NONPDQ_QUERY_MEM in the user configuration file, and *new_value* represents the value determined by Informix.

For formulas for estimating the amount of additional space to allocate for hash joins, see “Estimating temporary space for dbspaces and hash joins” on page 5-11.

The Memory Grant Manager (MGM) component of Informix coordinates the use of memory, CPU virtual processors (VPs), disk I/O, and scan threads among decision-support queries. The MGM uses the DS_MAX_QUERIES, DS_TOTAL_MEMORY, DS_MAX_SCANS, and MAX_PDQPRIORITY configuration parameters to determine the quantity of these PDQ resources that can be granted to a decision-support query. The MGM also grants memory to a query for such activities as hash joins. For more information about the MGM, see “The Memory Grant Manager” on page 12-6.

Optimize user-response time for queries

You can influence the amount of time that Informix takes to optimize a query and to return rows to a user.

Optimization level

You normally obtain optimum overall performance with the default optimization level, HIGH. The time that it takes to optimize the statement is usually unimportant. However, if experimentation with your application reveals that your query is still taking too long, you can set the optimization level to LOW.

If you change the optimization level to LOW, check the SET EXPLAIN output to see if the optimizer chose the same query plan as before.

To specify a HIGH or LOW level of database server optimization, use the SET OPTIMIZATION statement.

Related reference

 [SET OPTIMIZATION statement \(SQL Syntax\)](#)

Optimization goals

Optimizing total query time and optimizing user-response time are two optimization goals for improving query performance.

Total query time is the time it takes to return all rows to the application. Total query time is most important for batch processing or for queries that require all rows be processed before returning a result to the user, as in the following query:

```
SELECT count(*) FROM orders
WHERE order_amount > 2000;
```

User-response time is the time that it takes for the database server to return a screen full of rows back to an interactive application. In interactive applications, only a screen full of data can be requested at one time. For example, the user application can display only 10 rows at one time for the following query:

```
SELECT * FROM orders
WHERE order_amount > 2000;
```

Which optimization goal is more important can have an effect on the query path that the optimizer chooses. For example, the optimizer might choose a nested-loop join instead of a hash join to execute a query if user-response time is most important, even though a hash join might result in a reduction in total query time.

Specifying the query performance goal

You can optimize user response time for your entire database server system, within a session, or for individual queries.

The default behavior is for the optimizer to choose query plans that optimize the total query time. You can specify optimization of user-response time at several different levels:

- For the database server system

To optimize user-response time, set the OPT_GOAL configuration parameter to 0, as in the following example:

```
OPT_GOAL 0
```

Set OPT_GOAL to -1 to optimize total query time.

- For the user environment

The **OPT_GOAL** environment variable can be set before the user application starts.

UNIX Only

To optimize user-response time, set the **OPT_GOAL** environment variable to 0, as in the following sample commands:

```
Bourne shell      OPT_GOAL = 0
                  export OPT_GOAL

C shell          setenv OPT_GOAL 0
```

For total-query-time optimization, set the **OPT_GOAL** environment variable to -1.

- Within the session

You can control the optimization goal with the SET OPTIMIZATION statement in SQL. The optimization goal set with this statement stays in effect until the session ends or until another SET OPTIMIZATION statement changes the goal. The following statement causes the optimizer to choose query plans that favor total-query-time optimization:

```
SET OPTIMIZATION ALL_ROWS
```

The following statement causes the optimizer to choose query plans that favor user-response-time optimization:

```
SET OPTIMIZATION FIRST_ROWS
```

- For individual queries

You can use FIRST_ROWS and ALL_ROWS optimizer directives to instruct the optimizer which query goal to use. For more information about these directives, see “Optimization-goal directives” on page 11-7.

The precedence for these levels is as follows:

- Optimizer directives
- SET OPTIMIZATION statement
- **OPT_GOAL** environment variable
- **OPT_GOAL** configuration parameter

For example, optimizer directives take precedence over the goal that the SET OPTIMIZATION statement specifies.

Preferred query plans for user-response-time optimization

When the optimizer chooses query plans to optimize user-response time, it computes the cost for retrieving the first row in the query for each plan and chooses the plan with the lowest cost. In some cases, the query plan with the lowest cost for retrieving the first row might not be the optimal path to retrieve all rows in the query.

The following sections explain some of the possible differences in query plans.

Nested-loop joins versus hash joins:

Hash joins generally have a higher cost to retrieve the first row than nested-loop joins do. The database server must build the hash table before it retrieves any rows. However, in some cases, total query time is faster if the database server uses a hash join.

In the following example, **tab2** has an index on **col1**, but **tab1** does not have an index on **col1**. When you execute `SET OPTIMIZATION ALL_ROWS` before you run the query, the database server uses a hash join and ignores the existing index, as the following portion of `SET EXPLAIN` output shows:

```
QUERY:
-----
SELECT * FROM tab1,tab2
WHERE tab1.col1 = tab2.col1
Estimated Cost: 125
Estimated # of Rows Returned: 510
1) lsuto.tab2: SEQUENTIAL SCAN
2) lsuto.tab1: SEQUENTIAL SCAN
DYNAMIC HASH JOIN
   Dynamic Hash Filters: lsuto.tab2.col1 = lsuto.tab1.col1
```

However, when you execute `SET OPTIMIZATION FIRST_ROWS` before you run the query, the database server uses a nested-loop join. The clause (`FIRST_ROWS OPTIMIZATION`) in the following partial `SET EXPLAIN` output shows that the optimizer used user-response-time optimization for the query:

```
QUERY:          (FIRST_ROWS OPTIMIZATION)
-----
SELECT * FROM tab1,tab2
WHERE tab1.col1 = tab2.col1
Estimated Cost: 145
Estimated # of Rows Returned: 510
1) lsuto.tab1: SEQUENTIAL SCAN
2) lsuto.tab2: INDEX PATH
   (1) Index Keys: col1
       Lower Index Filter: lsuto.tab2.col1 = lsuto.tab1.col1
NESTED LOOP JOIN
```

Table scans versus index scans:

In cases where the database server returns a large number of rows from a table, the lower-cost option for the total-query-time goal might be to scan the table instead of using an index. However, to retrieve the first row, the lower-cost option for the user-response-time goal might be to use the index to access the table.

Ordering with fragmented indexes:

When an index is not fragmented, the database server can use the index to avoid a sort. However, when an index is fragmented, the ordering can be guaranteed only within the fragment, not between fragments.

Usually, the least expensive option for the total-query-time goal is to scan the fragments in parallel and then use the parallel sort to produce the proper ordering. However, this option does not favor the user-response-time goal.

Instead, if the user-response time is more important, the database server reads the index fragments in parallel and merges the data from all of the fragments. No additional sort is generally needed.

Related concepts

“Avoid or simplify sort operations” on page 13-31

Optimize queries for user-defined data types

Queries that access user-defined data types (UDTs) can take advantage of the same performance features that built-in data types use.

These features are:

- Indexes
If a query accesses a small number of rows, an index speeds retrieval because the database server does not need to read every page in a table to find the rows. For more information, see “Indexes on user-defined data types” on page 7-16.
- Parallel database query (PDQ)
Queries that access user-defined data can take advantage of parallel scans and parallel execution.
To turn on parallel execution for a query, set the **PDQPRIORITY** environment variable or use the SQL statement **SET PDQPRIORITY**. For more information about how to set PDQ priority and configuration parameters that affect PDQ, see “The allocation of resources for parallel database queries” on page 12-7.
- Optimizer directives

In addition, programmers can write the following functions or UDRs to help the optimizer create an efficient query plan for your queries:

- Parallel UDRs that can take advantage of parallel database queries
- User-defined selectivity functions that calculate the expected fraction of rows that qualify for the function
- User-defined cost functions that calculate the expected relative cost to execute a user-defined routine
- User-defined statistical functions that the **UPDATE STATISTICS** statement can use to generate statistics and data distributions
- User-defined negator functions to allow more choices for the optimizer

The following sections summarize these techniques. For a more complete description of how to write and register user-defined selectivity functions and user-defined cost functions, see *IBM Informix User-Defined Routines and Data Types Developer's Guide*.

Parallel UDRs

One way to execute UDRs is in an expression in a query. You can take advantage of parallel execution if the UDR is in an expression in the query.

For parallel execution, the UDR must be in one of the following parts of a query:

- WHERE clause
- SELECT list
- GROUP by list
- Overloaded comparison operator
- User-defined aggregate
- HAVING clause
- Select list for a parallel insertion statement

- Generic B-tree index scan on multiple index fragments provided that the compare function used in the B-tree index scan is parallelizable

For example, suppose you create an opaque data type **circle**, a table **cir_t** that defines a column of type **circle**, a user-defined routine **area**, and then execute the following sample query:

```
SELECT circle, area(circle)
   FROM cir_t
   WHERE circle > "(6,2,4)";
```

In this sample query, the following operations can execute in parallel:

- The UDR **area(circle)** in the SELECT list
If the table **cir_t** is fragmented, multiple **area** UDRs can execute in parallel, one UDR on each fragment.
- The expression **circle > "(6,2,4)"** in the WHERE clause
If the table **cir_t** is fragmented, multiple scans of the table can execute in parallel, one scan on each fragment. Then multiple ">" comparison operators can execute in parallel, one operator per fragment.

By default, a UDR does not execute in parallel. To enable parallel execution of UDRs, you must take the following actions:

- Specify the **PARALLELIZABLE** modifier in the **CREATE FUNCTION** or **ALTER FUNCTION** statement.
- Ensure that the UDR does not call functions that are not PDQ thread-safe.
- Turn on PDQ priority.
- Use the UDR in a parallel database query.

Selectivity and cost functions

You can use the **CREATE FUNCTION** statement to create a UDR. Then, you can use routine modifiers to change the cost or selectivity that is specified in the statement.

After you create a UDR, you can place it in an SQL statement.

The following example shows how you can place a UDR in an SQL statement:

```
SELECT * FROM image
WHERE get_x1(image.im2) and get_x2(image.im1)
```

The optimizer cannot accurately evaluate the cost of executing a UDR without additional information. You can provide the cost and selectivity of the function to the optimizer. The database server uses cost and selectivity together to determine the best path. For more information about selectivity, see “Filters with user-defined routines” on page 13-2.

In the previous example, the optimizer cannot determine which function to execute first, the **get_x1** function or the **get_x2** function. If a function is expensive to execute, the DBA can assign the function a larger cost or selectivity, which can influence the optimizer to change the query plan for better performance. In the previous example, if **get_x1** costs more to execute, the DBA can assign a higher cost to the function, which can cause the optimizer to execute the **get_x2** function first.

You can add the following routine modifiers to the **CREATE FUNCTION** statement to change the cost or selectivity that the optimizer assigns to the function:

- **selfunc**=*function_name*
- **selconst**=*integer*
- **costfunc**=*function_name*
- **percall_cost**=*integer*

For more information about cost or selectivity modifiers, see the *IBM Informix User-Defined Routines and Data Types Developer's Guide*.

User-defined statistics for UDTs

Because information about the nature and use of a user-defined data type (UDT) is not available to the database server, it cannot collect distributions or the **colmin** and **colmax** information (found in the **syscolumns** system catalog table) for a UDT. Instead, you can create a special function that populates these statistics.

The database server runs the statistics collection function when you execute UPDATE STATISTICS.

For more information about the importance of updating statistics, see “Statistics held for the table and index” on page 10-18. For information about improving performance, see “Updating statistics for columns with user-defined data types” on page 13-16.

Negator functions

A *negator function* takes the same arguments as its companion function, in the same order, but returns the Boolean complement. That is, if a function returns TRUE for a given set of arguments, its negator function returns FALSE when passed the same arguments, in the same order.

In certain cases, the database server can process a query more efficiently if the sense of the query is reversed. That is, “Is x greater than y?” changes to “Is y less than or equal to x?”

SQL statement cache

Before the database server executes an SQL statement, it must first parse and optimize the statement. These steps can be time consuming, depending on the size of the SQL statement.

The database server can store the parsed and optimized SQL statement in the virtual portion of shared memory, in an area called the *SQL statement cache*. The SQL statement cache (SSC) can be accessed by all users, and it allows users to bypass the parse and optimize steps before they execute the query. This capability can result in the following significant performance improvements:

- Reduced response times when users are executing the same SQL statements.
SQL statements that take longer to optimize (usually because they include many tables and many filters in the WHERE clause) execute faster from the SQL statement cache because the database server does not need to parse or optimize the statement.
- Reduced memory usage because the database server shares query data structures among users.

Memory reduction with the SQL statement cache is greater when a statement has many column names in the select list.

For more information about the effect of the SQL statement cache on the performance of the overall system, see “SQL statement cache” on page 4-29.

When to use the SQL statement cache

Applications might benefit from use of the SQL statement cache if multiple users execute the same SQL statements. The database server considers statements to be the same if all characters match exactly.

For example, if 50 sales representatives execute the **add_order** application throughout the day, they all execute the same SQL statements if the application contains SQL statements that use host variables, such as the following example:

```
SELECT * FROM ORDERS WHERE order_num = :hostvar
```

This kind of application benefits from use of the SQL statement cache because users are likely to find the SQL statements in the SQL statement cache.

The database server does not consider the following SQL statements exact matches because they contain different literal values in the WHERE clause:

```
SELECT * FROM customer, orders
  WHERE customer.customer_num = orders.customer_num
  AND order_date > "01/01/07"
SELECT * FROM customer, orders
  WHERE customer.customer_num = orders.customer_num
  AND order_date > "01/01/2007"
```

Performance does not improve with the SQL statement cache in the following situations:

- If a report application is run once nightly, and it executes SQL statements that no other application uses, it does not benefit from use of the statement cache.
- If an application prepares a statement and then executes it many times, performance does not improve with the SQL statement cache because the statement is optimized just once during the PREPARE statement.

When a statement contains host variables, the database server replaces the host variables with placeholders when it stores the statement in the SQL statement cache. Therefore, the statement is optimized without the database server having access to the values of the host variables. In some cases, if the database server had access to the values of the host variables, the statement might be optimized differently, usually because the distributions stored for a column inform the optimizer exactly how many rows pass the filter.

If an SQL statement that contains host variables performs poorly with the SQL statement cache turned on, try flushing the SQL statement cache with the **onmode -e flush** command and running the query with values that are more frequently used across multiple executions of the query. When you flush the cache, the database server reoptimizes the query and generates a query plan that is optimized for these frequently used values.

Important: The database server flushes an entry from the SQL statement cache only if it is not in use. If an application prepares the statement and keeps it, the entry is still in use. In this case, the application needs to close the statement before the flush is beneficial.

Using the SQL statement cache

The DBA usually makes the decision to enable the SQL statement cache. If the SQL statement cache is enabled, individual users can decide whether or not to use the SQL statement cache for their specific environment or application.

The database server incurs some processing overhead in managing the SQL statement cache, so you should use the SQL statement cache only when multiple users want to share the SQL statements.

To enable the SQL statement cache, set the `STMT_CACHE` configuration parameter to a value that defines either of the following modes:

- Always use the SQL statement cache unless a user explicitly specifies do not use the cache.
- Use the SQL statement cache only when a user explicitly specifies use it.

For more information, see “Enabling the SQL statement cache.” For more information about the `STMT_CACHE` configuration parameter, see the *IBM Informix Administrator’s Reference*.

Enabling the SQL statement cache

The database server does not use the SQL statement cache when the `STMT_CACHE` configuration parameter is 0 (the default value). You can change this value to enable the SQL statement cache in one of two modes.

Use one of the following methods to change this `STMT_CACHE` default value:

- Update the `ONCONFIG` file to specify the `STMT_CACHE` configuration parameter and restart the database server.

If you set the `STMT_CACHE` configuration parameter to 1, the database server uses the SQL statement cache for an individual user when the user sets the `STMT_CACHE` environment variable to 1 or executes the `SET STATEMENT CACHE ON` statement within an application.

```
STMT_CACHE 1
```

If the `STMT_CACHE` configuration parameter is 2, the database server stores SQL statements for all users in the SQL statement cache except when individual users turn off the feature with the `STMT_CACHE` environment variable or the `SET STATEMENT CACHE OFF` statement.

```
STMT_CACHE 2
```

- Use the `onmode -e` command to override the `STMT_CACHE` configuration parameter dynamically.

If you use the `enable` keyword, the database server uses the SQL statement cache for an individual user when the user sets the `STMT_CACHE` environment variable to 1 or executes the `SET STATEMENT CACHE ON` statement within an application.

```
onmode -e enable
```

If you use the `on` keyword, the database server stores SQL statements for all users in the SQL statement cache except when individual users turn off the feature with the `STMT_CACHE` environment variable or the `SET STATEMENT CACHE OFF` statement.

```
onmode -e on
```

The following table summarizes the use of the SQL statement cache, which depends on the setting of the `STMT_CACHE` configuration parameter (or the

execution of **onmode -e**) and the use in an application of the **STMT_CACHE** environment variable and the **SET STATEMENT CACHE** statement.

STMT_CACHE Configuration Parameter or onmode -e	STMT_CACHE Environment Variable	SET STATEMENT CACHE Statement	Resulting Behavior
0 (default)	Not applicable	Not applicable	Statement cache not used
1	0 (or not set)	OFF	Statement cache not used
1	1	OFF	Statement cache not used
1	0 (or not set)	ON	Statement cache used
1	1	ON	Statement cache used
1	1	Not executed	Statement cache used
1	0	Not executed	Statement cache not used
2	1 (or not set)	ON	Statement cache used
2	1 (or not set)	OFF	Statement cache not used
2	0	ON	Statement cache used
2	0	OFF	Statement cache not used by user
2	0	Not executed	Statement cache not used by user
2	1 (or not set)	Not executed	Statement cache used by user

Placing statements in the cache

SELECT, UPDATE, INSERT and DELETE statements can be placed in the SQL statement cache, with some exceptions. When the database server checks if an SQL statement is in the cache, it must find an exact match.

For a complete list of the exceptions and a list of requirements for an exact match, see **SET STATEMENT CACHE** in the *IBM Informix Guide to SQL: Syntax*.

Monitoring memory usage for each session

You can use the **onstat -u** command and several **onstat -g** command options to obtain memory information for each session.

You obtain memory information by identifying the SQL statements that use a large amount of memory.

To identify SQL statements using large amount of memory:

1. Run the **onstat -u** command to display all user threads.
2. Run the **onstat -g ses** command to display memory of all sessions and see which session has the highest memory usage.
3. Run the **onstat -g ses session-id** command to display more details on the session with the highest memory usage.
4. Run the **onstat -g stm session-id** command to display the memory used by the SQL statements.

Display all user threads and session memory usage

Use the **onstat -u** command to display all user threads and memory usage by session ID.

When the session shares the memory structures in the SSC, the value in the **used memory** column should be lower than when the cache is turned off. For example, Figure 13-6 shows sample **onstat -u** output when the SQL statement cache is not enabled, and Figure 13-7 shows output after it is enabled and the queries in Session 4 are run again. Figure 13-6 shows that Session 4 has 45656 bytes of used memory. Figure 13-7 shows that Session 4 has less used bytes (36920) when the SSC is enabled.

session				#RSAM	total	used	
id	user	tty	pid	hostname	threads	memory	memory
12	informix	-	0	-	0	12288	7632
4	informix	11	5158	smoke	1	53248	45656
3	informix	-	0	-	0	12288	8872
2	informix	-	0	-	0	12288	7632

Figure 13-6. **onstat -u** Output when the SQL statement cache is not enabled

session				#RSAM	total	used	
id	user	tty	pid	hostname	threads	memory	memory
17	informix	-	0	-	0	12288	7632
16	informix	12	5258	smoke	1	40960	38784
4	informix	11	5158	smoke	1	53248	36920
3	informix	-	0	-	0	12288	8872
2	informix	-	0	-	0	12288	7632

Figure 13-7. **onstat -u** Output when the SQL statement cache is enabled

Figure 13-7 also shows the memory allocated and used for Session 16, which executes the same SQL statements as Session 4. Session 16 allocates less total memory (40960) and uses less memory (38784) than Session 4 (Figure 13-6 shows 53248 and 45656, respectively) because it uses the existing memory structures in the SQL statement cache.

Display detailed session information and memory usage

Use the **onstat -g ses session-id** command to display detailed information for a session, including memory usage.

The following **onstat -g ses session-id** output columns display memory usage:

- The Memory pools portion of the output
 - The **totalsize** column shows the number of bytes currently allocated
 - The **freesize** column shows the number of unallocated bytes
- The last line of the output shows the number of bytes allocated from the sscpool.

Figure 13-8 on page 13-44 shows that Session 16 has currently allocated 69632 bytes, of which 11600 bytes are allocated from the sscpool.

```

onstat -g ses 14

session
id      user      tty      pid      hostname #RSAM  total  used
14      virginia  7        28734    lyceum   1       69632  67384

tid      name      rstcb    flags    curstk   status
38      sqlxec    a3974d8  Y--P---  1656    cond wait(netnorm)

Memory pools      count 1
name      class addr      totalsize freesize #allocfrag #freefrag
14        V      a974020  69632  2248  156      2

...
Sess  SQL      Current      Iso Lock      SQL  ISAM F.E.
Id    Stmt type Database      Lvl Mode      ERR  ERR  Vers
14    SELECT   vjp_stores   CR  Not Wait    0   0   9.03

Current statement name : slctcur

Current SQL statement :
  SELECT C.customer_num, O.order_num FROM customer C, orders O, items I
  WHERE C.customer_num = O.customer_num AND O.order_num = I.order_num

Last parsed SQL statement :
  SELECT C.customer_num, O.order_num FROM customer C, orders O, items I
  WHERE C.customer_num = O.customer_num AND O.order_num = I.order_num

11600 byte(s) of memory is allocated from the sscpool

```

Figure 13-8. onstat -g ses session-id output

Display information about session SQL statements

Use the **onstat -g sql session-id** command to display information about the SQL statements executed by a session.

The following figure shows that **onstat -g sql session-id** displays the same information as the bottom portion of the **onstat -g ses session-id** command in Figure 13-8, which includes the number of bytes allocated from the sscpool.

```

onstat -g sql 14

Sess SQL          Current          Iso Lock      SQL ISAM F.E.
Id   Stmt type    Database        Lvl Mode      ERR ERR  Vers
14   SELECT       vjp_stores     CR  Not Wait    0   0   9.03

Current statement name : slctcur

Current SQL statement :
  SELECT C.customer_num, O.order_num FROM customer C, orders O, items I
  WHERE C.customer_num = O.customer_num AND O.order_num = I.order_num

Last parsed SQL statement :
  SELECT C.customer_num, O.order_num FROM customer C, orders O, items I
  WHERE C.customer_num = O.customer_num AND O.order_num = I.order_num

11600 byte(s) of memory is allocated from the sscpool

```

Figure 13-9. onstat -g sql session-id output

Display information about the memory that SQL statements use in a session

Use the **onstat -g stm session-id** to display information about the memory each SQL statement uses in a session.

The following figure displays the output of **onstat -g stm session-id** for the same session (14) as in **onstat -g ses session-id** in Figure 13-8 on page 13-44 and **onstat -g sql session-id** in Figure 13-9.

When the SQL statement cache (SSC) is on, the database server creates the heaps in the SSC pool. Therefore, the **heapsz** output field in Figure 13-10 shows that this SQL statement uses 10056 bytes, which is contained within the 11600 bytes in the SSC pool that the **onstat -g sql 14** shows.

```

onstat -g stm 14

session 14 -----
sdblock heapsz statement ('*' = Open cursor)
aa11018 10056 *SELECT C.customer_num, O.order_num
FROM customer C, orders O, items I
WHERE C.customer_num = O.customer_num
AND O.order_num = I.order_num

```

Figure 13-10. onstat -g stm session-id output

Monitoring usage of the SQL statement cache

If you notice a sudden increase in response time for a query that had been using the SQL statement cache, the entry might have been dropped or deleted. You can monitor the usage of the SQL statement cache and check for a dropped or deleted entry by displaying **onstat -g ssc** command output.

The database server drops an entry from the cache when one of the objects that the query depends on is altered so that it invalidates the data dictionary cache entry for the query. The following operations cause a dependency check failure:

- Execution of any data definition language (DDL) statement (such as ALTER TABLE, DROP INDEX, or CREATE INDEX) that might alter the query plan
- Alteration of a table that is linked to another table with a referential constraint (in either direction)
- Execution of UPDATE STATISTICS FOR TABLE for any table or column involved in the query
- Renaming a column, database, or index with the RENAME statement

When an entry is marked as dropped or deleted, the database server must reparse and reoptimize the SQL statement the next time it executes. For example, Figure 13-11 shows the entries that the **onstat -g ssc** command displays after UPDATE STATISTICS was executed on the **items** and **orders** table between the execution of the first and second SQL statements.

The Statement Cache Entries portion of the **onstat -g ssc** output in Figure 13-11 displays a **flag** field that indicates whether or not an entry has been dropped or deleted from the SQL statement cache.

- The first entry has a **flag** column with the value DF, which indicates that the entry is fully cached, but is now dropped because its entry was invalidated.
- The second entry has the same statement text as the third entry, which indicates that it was reparsed and reoptimized when it was executed after the UPDATE STATISTICS statement.

```

onstat -g ssc
...
Statement Cache Entries:
lru hash ref_cnt hits  flag heap_ptr database user
-----
...
2 232      1  1  DF aa3d020 vjp_stores  virginia
SELECT C.customer_num, O.order_num
FROM customer C, orders O, items I
WHERE C.customer_num = O.customer_num
AND O.order_num = I.order_num

3 232      1  0  -F aa8b020 vjp_stores  virginia
SELECT C.customer_num, O.order_num
FROM customer C, orders O, items I
WHERE C.customer_num = O.customer_num
AND O.order_num = I.order_num
...

```

Figure 13-11. Sample **onstat -g ssc** command output for a dropped entry

Monitor sessions and threads

You can monitor the number of active sessions and threads and the amount of resources that they are using. Monitoring sessions and threads is important for sessions that perform queries as well as sessions that perform inserts, updates, and deletes.

Some of the information that you can monitor for sessions and threads allows you to determine if an application is using a disproportionate amount of the resources.

Note: Session threads for a stored procedure with a PDQ priority setting and a GROUP BY clause are not released until a session is completed.

Monitor sessions and threads with onstat commands

You can use several **onstat** utility commands to monitor active sessions and threads.

Use the following **onstat** utility commands to monitor sessions and threads:

- **onstat -u**
- **onstat -g ath**
- **onstat -a act**
- **onstat -a cpu**
- **onstat -a ses**
- **onstat -g mem**
- **onstat -g stm**

Monitor threads with onstat -u output

Use the **onstat -u** command to display information about active threads that require a database server task-control block.

Active threads include threads that belong to user sessions, as well as some that correspond to database server daemons (for example, page cleaners). Figure 13-12 on page 13-48 shows an example of **onstat -u** output.

Also use the **onstat -u** command to determine if a user is waiting for a resource or holding too many locks, or to get an idea of how much I/O the user has performed.

The utility output displays the following information:

- The address of each thread
- Flags that indicate the present state of the thread (for example, waiting for a buffer or waiting for a checkpoint), whether the thread is the primary thread for a session, and what type of thread it is (for example, user thread, daemon thread, and so on)
For information on these flags, see the *IBM Informix Administrator's Reference*.
- The session ID and user login ID for the session to which the thread belongs
A session ID of 0 indicates a daemon thread.
- Whether the thread is waiting for a specific resource and the address of that resource
- The number of locks that the thread is holding
- The number of read calls and the number of write calls that the thread has executed
- The maximum number of current, active user threads

If you execute **onstat -u** while the database server is performing fast recovery, several database server threads might appear in the display.

Userthreads									
address	flags	sessid	user	tty	wait	tout	locks	nreads	nwrites
80eb8c	---P--D	0	informix	-	0	0	0	33	19
80ef18	---P--F	0	informix	-	0	0	0	0	0
80f2a4	---P--B	3	informix	-	0	0	0	0	0
80f630	---P--D	0	informix	-	0	0	0	0	0
80fd48	---P---	45	chrisw	ttyp3	0	0	1	573	237
810460	-----	10	chrisw	ttyp2	0	0	1	1	0
810b78	---PR--	42	chrisw	ttyp3	0	0	1	595	243
810f04	Y-----	10	chrisw	ttyp2	beacf8	0	1	1	0
811290	---P---	47	chrisw	ttyp3	0	0	2	585	235
81161c	---PR--	46	chrisw	ttyp3	0	0	1	571	239
8119a8	Y-----	10	chrisw	ttyp2	a8a944	0	1	1	0
81244c	---P---	43	chrisw	ttyp3	0	0	2	588	230
8127d8	----R--	10	chrisw	ttyp2	0	0	1	1	0
812b64	---P---	10	chrisw	ttyp2	0	0	1	20	0
812ef0	---PR--	44	chrisw	ttyp3	0	0	1	587	227

15 active, 20 total, 17 maximum concurrent

Figure 13-12. **onstat -u** output

Monitor threads with **onstat -g ath** output

Use the **onstat -g ath** command to view a list of all threads. Unlike the **onstat -u** command, this list includes internal daemon threads that do not have a database server task-control block.

The **onstat -g ath** command display does not include the session ID (because not all threads belong to sessions).

The status field contains information on the status of thread, such as running, cond wait, IO Idle, IO Idle, sleeping secs: *number_of_seconds*, or sleeping forever. The following output example identifies many threads as sleeping forever. To improve performance, you can remove or reduce the number of threads that are identified as sleeping forever.

Threads:						
tid	tcb	rstcb	prty	status	vp-class	name
2	10bbf36a8	0	2	sleeping forever	3lio	lio vp 0
3	10bc12218	0	2	sleeping forever	4pio	pio vp 0
4	10bc31218	0	2	sleeping forever	5aio	aio vp 0
5	10bc50218	0	2	sleeping forever	6msc	msc vp 0
6	10bc7f218	0	2	sleeping forever	7aio	aio vp 1
7	10bc9e540	10b231028	4	sleeping secs: 1	1cpu	main_loop()
8	10bc12548	0	2	running	1cpu	tlitcpoll
9	10bc317f0	0	3	sleeping forever	1cpu	tlitcplst
10	10bc50438	10b231780	2	sleeping forever	1cpu	flush_sub(0)
11	10bc7f740	0	2	sleeping forever	8aio	aio vp 2
12	10bc7fa00	0	2	sleeping forever	9aio	aio vp 3
13	10bd56218	0	2	sleeping forever	10aio	aio vp 4
14	10bd75218	0	2	sleeping forever	11aio	aio vp 5
15	10bd94548	10b231ed8	3	sleeping forever	1cpu	aslogflush
16	10bc7fd00	10b232630	1	sleeping secs: 26	1cpu	btscanner 0
32	10c738ad8	10b233c38	4	sleeping secs: 1	1cpu	onmode_mon
50	10c0db710	10b232d88	2	cond wait netnorm	1cpu	sqlxec

Figure 13-13. **onstat -g ath** output

Threads that a primary decision-support thread started have a name that indicates their role in the decision-support query. The following figure shows four scan threads that belong to a decision-support thread.

Threads:						
tid	tcb	rstcb	prty	status	vp-class	name
11	994060	0	4	sleeping(Forever)	1cpu	kaio
12	994394	80f2a4	2	sleeping(secs: 51)	1cpu	btclean
26	99b11c	80f630	4	ready	1cpu	onmode_mon
32	a9a294	812b64	2	ready	1cpu	sqlxec
113	b72a7c	810b78	2	ready	1cpu	sqlxec
114	b86c8c	81244c	2	cond wait(netnorm)	1cpu	sqlxec
115	b98a7c	812ef0	2	cond wait(netnorm)	1cpu	sqlxec
116	bb4a24	80fd48	2	cond wait(netnorm)	1cpu	sqlxec
117	bc6a24	81161c	2	cond wait(netnorm)	1cpu	sqlxec
118	bd8a24	811290	2	ready	1cpu	sqlxec
119	beae88	810f04	2	cond wait(await_MC1)	1cpu	scan_1.0
120	a8ab48	8127d8	2	ready	1cpu	scan_2.0
121	a96850	810460	2	ready	1cpu	scan_2.1
122	ab6f30	8119a8	2	running	1cpu	scan_2.2

Figure 13-14. **onstat -g ath** output showing scan threads belonging to a decision-support thread

Monitor threads with **onstat -g act** output

Use the **onstat -g act** command to obtain a list of active threads. The **onstat -g act** output shows a subset of the threads that are also listed in **onstat -g ath** output.

For sample output, see the *IBM Informix Administrator's Reference*.

Monitor threads with **onstat -g cpu** output

Use the **onstat -g cpu** command to display the last time the thread ran, how much CPU time the thread used, the number of times the thread ran, and other statistics about all the threads running in the server

The following output example shows the ID and name of each thread that is running, the ID of the virtual processor in which each thread is running, the day and time when each thread last ran, how much CPU time each thread used, the number of times each thread was scheduled to run, and the status of each thread.

```

Thread CPU Info:
tid  name          vp      Last Run          CPU Time    #scheds    status
2    lio vp 0       3lio*   07/18 08:35:35   0.0000     1          IO Idle
3    pio vp 0       4pio*   07/18 08:35:36   0.0102     2          IO Idle
4    aio vp 0       5aio*   07/18 08:35:47   0.6876     68         IO Idle
5    msc vp 0       6msc*   07/18 11:47:24   0.0935     14         IO Idle
6    main_loop()    1cpu*   07/18 15:02:43   2.9365     23350      sleeping secs: 1
7    soctcppoll     7soc*   07/18 08:35:40   0.1150     1          running
8    soctcpio       8soc*   07/18 08:35:40   0.0037     1          running
9    soctcplst     1cpu*   07/18 11:47:24   0.1106     10         sleeping forever
10   soctcplst     1cpu*   07/18 08:35:40   0.0103     6          sleeping forever
11   flush_sub(0)   1cpu*   07/18 15:02:43   0.0403     23252      sleeping secs: 1
12   flush_sub(1)   1cpu*   07/18 15:02:43   0.0423     23169      sleeping secs: 1
13   flush_sub(2)   1cpu*   07/18 15:02:43   0.0470     23169      sleeping secs: 1
14   flush_sub(3)   1cpu*   07/18 15:02:43   0.0407     23169      sleeping secs: 1
15   flush_sub(4)   1cpu*   07/18 15:02:43   0.0307     23169      sleeping secs: 1
16   flush_sub(5)   1cpu*   07/18 15:02:43   0.0323     23169      sleeping secs: 1
17   flush_sub(6)   1cpu*   07/18 15:02:43   0.0299     23169      sleeping secs: 1
18   flush_sub(7)   1cpu*   07/18 15:02:43   0.0314     23169      sleeping secs: 1
19   kaio          1cpu*   07/18 14:56:42   1.4560     2375587    IO Idle
20   aslogflush     1cpu*   07/18 15:02:43   0.0657     23166      sleeping secs: 1
21   btscanner_0    1cpu*   07/18 15:00:53   0.0484     784        sleeping secs: 61
37   onmode_mon     1cpu*   07/18 15:02:43   0.3467     23165      sleeping secs: 1
43   dbScheduler    1cpu*   07/18 14:58:14   1.6613     320        sleeping secs: 31
44   dbWorker1      1cpu*   07/18 13:48:10   0.4264     399        sleeping forever
45   dbWorker2      1cpu*   07/18 14:48:11   1.9346     2936       sleeping forever
94   bf_priosweep() 1cpu*   07/18 15:01:42   0.0431     77         cond wait bp_cond

```

Figure 13-15. `onstat -g cpu` command output

Monitor session resources with `onstat -g ses` output

Use the `onstat -a ses` command to monitor the resources allocated for and used by a session, in particular, a session that is running a decision-support query.

For example, in Figure 13-16, session number 49 is running five threads for a decision-support query.

session					#RSAM	total	used
id	user	tty	pid	hostname	threads	memory	memory
57	informix	-	0	-	0	8192	5908
56	user_3	ttyp3	2318	host_10	1	65536	62404
55	user_3	ttyp3	2316	host_10	1	65536	62416
54	user_3	ttyp3	2320	host_10	1	65536	62416
53	user_3	ttyp3	2317	host_10	1	65536	62416
52	user_3	ttyp3	2319	host_10	1	65536	62416
51	user_3	ttyp3	2321	host_10	1	65536	62416
49	user_1	ttyp2	2308	host_10	5	188416	178936
2	informix	-	0	-	0	8192	6780
1	informix	-	0	-	0	8192	4796

Figure 13-16. `onstat -a ses` output

Monitor session memory with `onstat -g mem` and `onstat -g stm` output

Use the `onstat -g mem` and `onstat -g stm` commands to obtain information about the memory used for each session.

You can determine which session to focus on by the **used memory** column of the `onstat -g ses` output.

Figure 13-17 shows sample `onstat -g ses` output and some of the `onstat -g mem` and `onstat -g stm` output for Session 16.

- The output of the `onstat -g mem` command shows the total amount of memory used by each session.

The `totalsize` column of the `onstat -g mem 16` output shows the total amount of memory allocated to the session.

- The output of the `onstat -g stm` command shows the portion of the total memory allocated to the current prepared SQL statement.

The `heapsz` column of the `onstat -g stm 16` output in the following figure shows the amount of memory allocated for the current prepared SQL statement.

```

onstat -g ses

session
id      user      tty      pid      hostname  #RSAM  total  used
      user      tty      pid      hostname  threads memory memory
18      informix -        0        -        0        12288  8928
17      informix 12       28826    lyceum    1        45056  33752
16      virginia 6        28743    lyceum    1        90112  79504
14      virginia 7        28734    lyceum    1        45056  33096
3       informix -        0        -        0        12288  10168
2       informix -        0        -        0        12288  8928

onstat -g mem 16

Pool Summary:
name      class addr      totalsize freesize #allocfrag #freefrag
16        V      a9ea020  90112    10608    159        5
...

onstat -g stm 16

session 16 -----
sdblock heapsz statement ('*' = Open cursor)
aa0d018 10056 *SELECT C.customer_num, 0.order_num
FROM customer C, orders O, items I
WHERE C.customer_num = O.customer_num
AND O.order_num = I.order_num

```

Figure 13-17. `onstat -g mem` and `onstat -g stm` to determine session memory

Monitor sessions and threads with ON-Monitor (UNIX)

On (UNIX), you can use ON-Monitor to view information about sessions and user threads. This information is a subset of the information that the `onstat -u` command displays.

Choose **User** from the Status menu. The following information appears:

- The session ID
- The user ID
- The number of locks that the thread is holding
- The number of read calls and write calls that the thread has executed
- Flags that indicate the present state of the thread (for example, waiting for a buffer or waiting for a checkpoint), whether the thread is the primary thread for a session, and what type of thread it is (for example, user thread, daemon thread, and so on)

The following figure shows sample output.

USER THREAD INFORMATION					
Session	User	Locks Held	Disk Reads	Disk Writes	User thread Status
0	informix	0	96	2	-----D
0	informix	0	0	0	-----F
0	informix	0	0	0	-----
15	informix	0	0	0	Y-----M
0	informix	0	0	0	-----D
17	chrisw	1	3	34	Y-----

Figure 13-18. Output from the User option of the ON-Monitor Status menu

Monitor sessions and threads with ISA

You can use ISA to monitor sessions and threads. ISA uses information generated by the **onstat -u** command.

To monitor user sessions with ISA, navigate to the **Users** page and click **Threads**. Click **Refresh** to rerun the commands and display fresh information.

Monitor sessions and threads with SMI tables

You can use the **sysessions** and the **sysesprof** system-monitoring interface (SMI) tables to obtain information about sessions and threads.

Query the **sysessions** table to obtain the following information.

Column

Description

sid Session ID

username

Name (login ID) of the user

uid User ID

pid Process ID

connected

Time that the session started

feprogram

Application that is running as the client (front-end program)

In addition, some columns contain flags that indicate if the *primary* thread of the session is waiting for a latch, lock, log buffer, or transaction; if it is an ON-Monitor thread; and if it is in a critical section.

Important: The information in the **sysessions** table is organized by session, and the information in the **onstat -u** output is organized by thread. Also, unlike the **onstat -u** output, the **sysessions** table does not include information about daemon threads, only user threads.

Query the **sysesprof** table to obtain a profile of the activity of a session. This table contains a row for each session with columns that store statistics on session activity (for example, number of locks held, number of row writes, number of commits, number of deletes, and so on).

For a complete list of the **sysessions** columns and descriptions of **sysesprof** columns, see the chapter on the **sysmaster** database in the *IBM Informix Administrator's Reference*.

Monitor transactions

You can monitor transactions to track open transactions and the locks that those transactions hold. You can use several **onstat** utility options and ISA to view transaction, lock, and session statistics.

ISA uses information that the following **onstat** command-line options generate to display session information, as the following table shows. Click the **Refresh** button to rerun the **onstat** command and display fresh information.

To Monitor	Select on ISA	Displays the Output of	See
Transaction statistics	Users > Transaction	onstat -x	"Display information about transactions"
User session statistics	Users > Threads	onstat -u	"Display statistics on user sessions" on page 13-55
Lock statistics	Performance > Locks	onstat -k	"Display information about transaction locks" on page 13-54
Sessions running SQL statements	Users > Connections > session-id	onstat -g sql session-id	"Display statistics on sessions executing SQL statements" on page 13-56

Display information about transactions

The output of the **onstat -x** command contains information that you can use to monitor transactions.

The **onstat -x** output contains the following information for each open transaction:

- The address of the transaction structure in shared memory
- Flags that indicate the following information:
 - The present state of the transaction (user thread attached, suspended, waiting for a rollback)
 - The mode in which the transaction is running (loosely coupled or tight coupled)
 - The stage that the transaction is in (BEGIN WORK, prepared to commit, committing or committed, rolling back)
 - The nature of the transaction (global transaction, coordinator, subordinate, both coordinator and subordinate)
- The thread that owns the transaction
- The number of locks that the transaction holds
- The logical-log file in which the BEGIN WORK record was logged
- The current logical-log id and position
- The isolation level
- The number of attempts to start a recovery thread
- The coordinator for the transaction (if the subordinate is executing the transaction)

- The maximum number of concurrent transactions since you last started the database server

The **onstat** utility is especially useful for monitoring global transactions. For example, you can determine whether a transaction is executing in loosely coupled or tightly coupled mode. These transaction modes have the following characteristics:

- Loosely coupled mode
 - Each branch in a global transaction has a separate transaction ID (XID). This mode is the default.
 - The different database servers coordinate transactions, but do not share resources. No two transaction branches, even if they access the same database, can share locks.
 - The records from all branches of a global transaction display as separate transactions in the logical log.
- Tightly coupled mode
 - In a single global transaction, all branches that access the same database share the same transaction ID (XID). This mode only occurs with the Microsoft Transaction Server (MTS) transaction manager.
 - The different database servers coordinate transactions and share resources such as locks and log records. The branches with the same XID share locks and can never wait on another branch with the same XID because only one branch is active at one time.
 - Log records for branches with the same XID appear under the same transaction in the logical log.

Figure 13-19 shows sample output from **onstat -x**. The last transaction listed is a global transaction, as the G value in the fifth position of the **flags** column indicates. The T value in the second position of the **flags** column indicates that the transaction is running in tightly coupled mode.

Transactions									
address	flags	userthread	locks	beginlg	curlog	logposit	isol	retrys	coord
ca0a018	A----	c9da018	0	0	5	0x18484c	COMMIT	0	
ca0a1e4	A----	c9da614	0	0	0	0x0	COMMIT	0	
ca0a3b0	A----	c9dac10	0	0	0	0x0	COMMIT	0	
ca0a57c	A----	c9db20c	0	0	0	0x0	COMMIT	0	
ca0a748	A----	c9db808	0	0	0	0x0	COMMIT	0	
ca0a914	A----	c9dbe04	0	0	0	0x0	COMMIT	0	
ca0aae0	A----	c9dcff8	1	0	0	0x0	COMMIT	0	
ca0acac	A----	c9dc9fc	1	0	0	0x0	COMMIT	0	
ca0ae78	A----	c9dc400	1	0	0	0x0	COMMIT	0	
ca0b044	AT--G	c9dc9fc	0	0	0	0x0	COMMIT	0	
10 active, 128 total, 10 maximum concurrent									

Figure 13-19. **onstat -x** output

The output in Figure 13-19 shows that this transaction branch is holding 13 locks. When a transaction runs in tightly coupled mode, the branches of this transaction share locks.

Display information about transaction locks

The output of the **onstat -k** command contains details on the locks that a transaction holds.

To find the relevant locks, match the address in the **userthread** column in **onstat -x** output to the address in the **owner** column of **onstat -k** output.

Figure 13-20 shows sample output from **onstat -x** and the corresponding **onstat -k** command. The a335898 value in the **userthread** column in the **onstat -x** output matches the value in the **owner** column of the two lines of **onstat -k** output.

```

onstat -x

Transactions
address  flags  userthread  locks  beginlg  curlog  logposit  isol  retrys  coord
a366018  A----  a334018    0      0        1      0x22b048  COMMIT  0
a3661f8  A----  a334638    0      0        0      0x0       COMMIT  0
a3663d8  A----  a334c58    0      0        0      0x0       COMMIT  0
a3665b8  A----  a335278    0      0        0      0x0       COMMIT  0
a366798  A----  a335898    2      0        0      0x0       COMMIT  0
a366d38  A----  a336af8    0      0        0      0x0       COMMIT  0
6 active, 128 total, 9 maximum concurrent

onstat -k

Locks
address  wtlist  owner  lklist  type  tblsnum  rowid  key#/bsiz
a09185c  0       a335898  0      HDR+S  100002  20a    0
a0918b0  0       a335898  a09185c HDR+S  100002  204    0
2 active, 2000 total, 2048 hash buckets, 0 lock table overflows

```

Figure 13-20. **onstat -k** and **onstat -x** output

In the example in Figure 13-20, a user is selecting a row from two tables. The user holds the following locks:

- A shared lock on one database
- A shared lock on another database

Display statistics on user sessions

The output of the **onstat -u** command contains statistics on user sessions.

You can find the session-id of the transaction by matching the address in the **userthread** column of the **onstat -x** output with the **address** column in the **onstat -u** output. The **sessid** column of the same line in the **onstat -u** output provides the session id.

For example, Figure 13-21 on page 13-56 shows the address a335898 in the **userthread** column of the **onstat -x** output. The output line in **onstat -u** with the same address shows the session id 15 in the **sessid** column.

```

onstat -x

Transactions
address  flags  userthread  locks  beginlg  curlog  logposit  isol  retrys  coord
a366018  A----  a334018    0      0        1      0x22b048  COMMIT  0
a3661f8  A----  a334638    0      0        0      0x0      COMMIT  0
a3663d8  A----  a334c58    0      0        0      0x0      COMMIT  0
a3665b8  A----  a335278    0      0        0      0x0      COMMIT  0
a366798  A----  a335898    2      0        0      0x0      COMMIT  0
a366d38  A----  a336af8    0      0        0      0x0      COMMIT  0
6 active, 128 total, 9 maximum concurrent

onstat -u

address  flags  sessid  user  tty  wait  tout  locks  nreads  nwrites
a334018  ---P--D 1    informix -    0      0      0      20      6
a334638  ---P--F 0    informix -    0      0      0      0      1
a334c58  ---P--- 5    informix -    0      0      0      0      0
a335278  ---P--B 6    informix -    0      0      0      0      0
a335898  Y--P--- 15    informix 1    a843d70 0      2      64      0
a336af8  ---P--D 11    informix -    0      0      0      0      0
6 active, 128 total, 17 maximum concurrent

```

Figure 13-21. Obtaining session-id for userthread in onstat -x

For a transaction executing in loosely coupled mode, the first position of the **flags** column in the **onstat -u** output might display a value of T. This T value indicates that one branch within a global transaction is waiting for another branch to complete. This situation could occur if two different branches in a global transaction, both using the same database, tried to work on the same global transaction simultaneously.

For a transaction executing in tightly coupled mode, this T value does not occur because the database server shares one transaction structure for all branches that access the same database in the global transaction. Only one branch is attached and active at one time and does not wait for locks because the transaction owns all the locks held by the different branches.

Display statistics on sessions executing SQL statements

The output of the **onstat -g sql** command contains statistics on the SQL statements executed by the session

To obtain information about the last SQL statement that each session executed, issue the **onstat -g sql** command with the appropriate session ID.

Figure 13-22 on page 14-1 shows sample output for this option using the same session ID obtained from the **onstat -u** sample in Figure 13-21.

```
onstat -g sql 15

Sess SQL          Current          Iso Lock        SQL ISAM F.E.
Id   Stmt type     Database        Lvl Mode       ERR ERR Vers
15   SELECT        vjp_stores     CR Not Wait    0   0   9.03

Current statement name : slctcur

Current SQL statement :
select l.customer_num, l.lname, l.company, l.phone, r.call_dtime,
       r.call_descr from customer l, vjp_stores@gilroy:cust_calls r where
       l.customer_num = r.customer_num

Last parsed SQL statement :
select l.customer_num, l.lname, l.company, l.phone, r.call_dtime,
       r.call_descr from customer l, vjp_stores@gilroy:cust_calls r where
       l.customer_num = r.customer_num
```

Figure 13-22. onstat -g sql output

Chapter 14. The onperf utility on UNIX

The **onperf** utility is a windowing environment that you can use to monitor the database server performance. The **onperf** utility monitors the database server running on the UNIX operating system.

Related reference

“Database server tools” on page 2-3

Overview of the onperf utility

The **onperf** utility is a graphical tool that you can use for displaying most of the same database server metrics that you can view on **onstat** utility reports.

The **onperf** utility provides the following advantages over the **onstat** utility:

- Displays metric values graphically in real time
- Allows you to choose which metrics to monitor
- Allows you to scroll back to previous metric values to analyze a trend
- Allows you to save performance data to a file for review at a later time

You cannot use the **onperf** utility on High-Availability Data Replication (HDR) secondary servers, remote standalone (RS) secondary servers, or shared disk (SD) secondary servers.

Basic onperf utility functions

The **onperf** utility displays the values of the database server metrics in a tool window and saves the database server metric values to a file. You can review the contents of this file.

Display metric values

The **onperf** utility displays database server metrics obtained from shared memory.

When **onperf** starts, it activates the following processes:

- **The onperf process.** This process controls the display of **onperf** tools.

- **The data-collector process.** This process attaches to shared memory and passes performance information to the **onperf** process for display in an **onperf** tool.

An **onperf** tool is a Motif window that an **onperf** process manages, as Figure 14-1 shows.

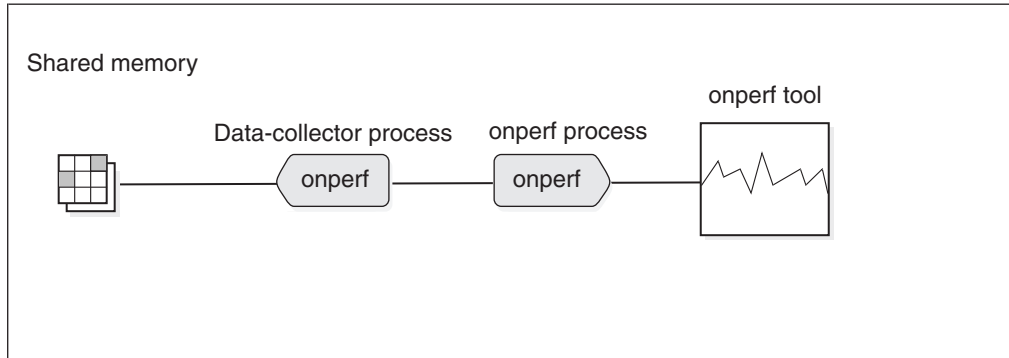

Figure 14-1. Data flow from shared memory to an *onperf* tool window

Save metric values to a file

The **onperf** utility saves collected metrics in a history file.

The **onperf** utility allows designated metrics to be continually buffered. The data collector writes these metrics to a circular buffer called the *data-collector buffer*. When the buffer becomes full, the oldest values are overwritten as the data collector continues to add data. The current contents of the data-collector buffer are saved to a history file, as Figure 14-2 illustrates.

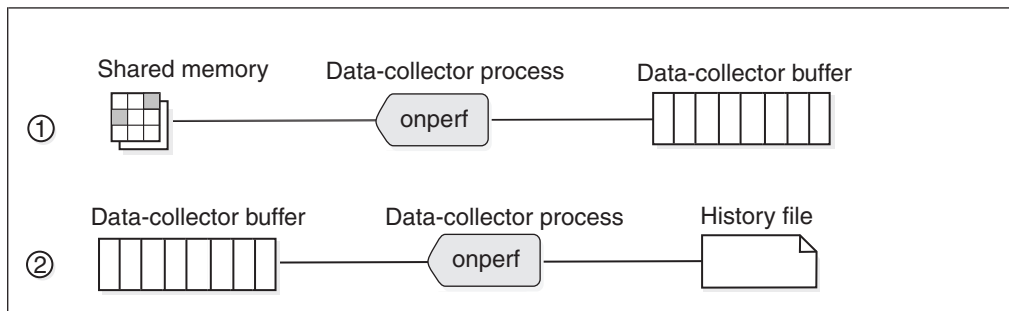

Figure 14-2. How *onperf* saves performance data

The **onperf** utility uses either a binary format or an ASCII representation for data in the history file. The binary format is host-dependent and allows data to be written quickly. The ASCII format is portable across platforms.

You have control over the set of metrics stored in the data-collector buffer and the number of samples. You could buffer all metrics; however, this action might consume more memory than is feasible. A single metric measurement requires 8 bytes of memory. For example, if the sampling frequency is one sample per second, then to buffer 200 metrics for 3,600 samples requires approximately 5.5 megabytes of memory. If this process represents too much memory, you must reduce the depth of the data-collector buffer, the sampling frequency, or the number of buffered metrics.

To configure the buffer depth or the sampling frequency, you can use the Configuration dialog box. For more information about the Configuration dialog box, see “The graph-tool Configure menu and the Configuration dialog box” on page 14-8.

Review metric measurements

You can review the contents of a history file in a tool window. When you request a tool to display a history file, the **onperf** utility starts a playback process that reads the data from disk and sends the data to the tool for display.

The playback process is similar to the data-collector process mentioned under “Save metric values to a file” on page 14-2. However, instead of reading data from shared memory, the playback process reads measurements from a history file. Figure 14-3 shows the playback process.

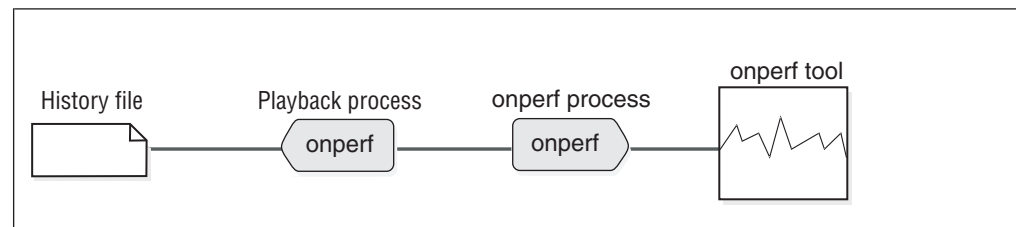

Figure 14-3. Flow of data from a history file to an onperf tool window

onperf utility tools

The **onperf** utility provides Motif windows, called *tools*, which display metric values.

Table 14-1. **onperf** utility tools

Tool	Description
Graph tool	This tool allows you to monitor general performance activity. You can use this tool to display any combination of metrics that onperf supports and to display the contents of a history file. For more information, see “Graph tool” on page 14-5.
Query-tree tool	This tool displays the progress of individual queries. For more information, see “Query-tree tool” on page 14-11.
Status tool	This tool displays status information about the database server and allows you to save the data that is currently held in the data-collector buffer to a file. For more information, see “Status tool” on page 14-11.
Activity tools	These tools display specific database server activities. Activity tools include disk, session, disk-capacity, physical-processor, and virtual-processor tools. The physical-processor and virtual-processor tools, respectively, display information about all CPUs and VPs. The other activity tools each display the top 10 instances of a resource ranked by a suitable activity measurement. For more information, see “Activity tools” on page 14-12.

Requirements for running the onperf utility

The computer that is running the **onperf** utility must support the X terminal and the **mwm** window manager.

When you install the database server, the following executable files are written to the `$INFORMIXDIR/bin` directory:

- **onperf**
- **onedcu**
- **onedpu**
- **xtree**

In addition, the **onperf.hlp** online help file is placed in the directory `$INFORMIXDIR/hhelp`.

When the database server is installed and running in online mode, you can bring up **onperf** tools either on the computer that is running the database server or on a remote computer or terminal that can communicate with your database server instance. Figure 14-4 illustrates both possibilities. In either case, the computer that is running the **onperf** tools must support the X terminal and the **mwm** window manager.

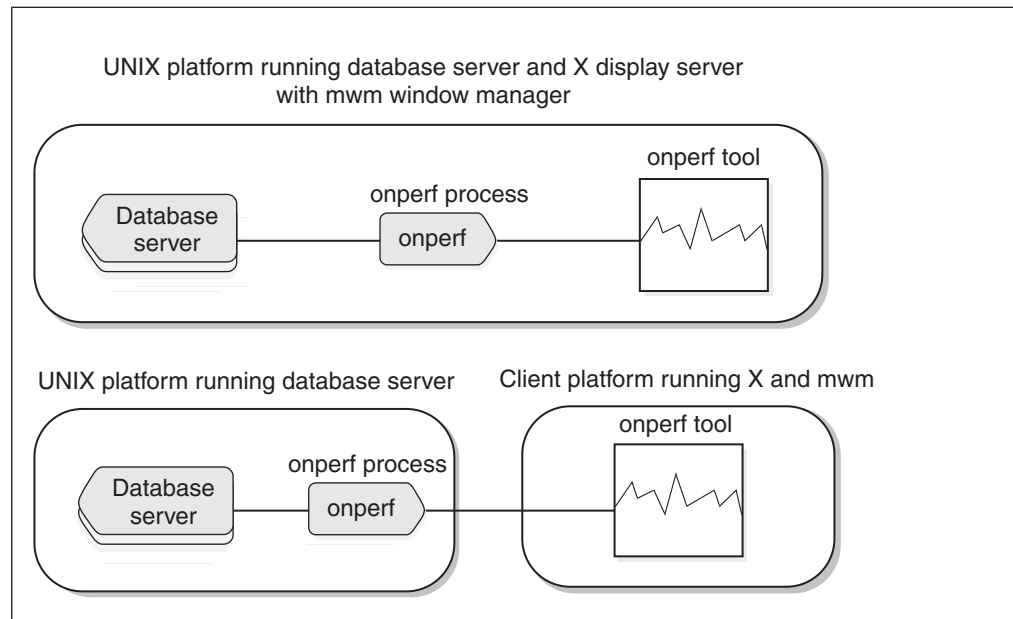

Figure 14-4. Two options for running **onperf**

Starting the **onperf** utility and exiting from it

Before you start the **onperf** utility, set the **DISPLAY** and **LD_LIBRARY_PATH** environment variables.

Prerequisite: Set the **DISPLAY** environment variable as follows:

```
C shell      setenv DISPLAY displayname0:0 #
 Bourne shell DISPLAY=displayname0:0 #
```

In these commands, *displayname* is the name of the computer or X terminal where the **onperf** window should appear.

Set the **LD_LIBRARY_PATH** environment variable to the appropriate value for the Motif libraries on the computer that is running **onperf**.

With the environment properly set up, you can enter **onperf** to bring up a graph-tool window, as described in "The onperf user interface."

You can monitor multiple database server instances from the same Motif client by invoking **onperf** for each database server, as the following example shows:

```
INFORMIXSERVER=instance1 ; export INFORMIXSERVER; onperf
INFORMIXSERVER=instance2 ; export INFORMIXSERVER; onperf
...
```

Exiting from the onperf Utility

To exit from the **onperf** utility, use the **Close** option to close each tool window, use the **Exit** option of a tool, or choose **Window Manager > Close**.

The onperf user interface

When you invoke the **onperf** utility, it displays an initial graph-tool window. From this graph-tool window, you can display additional graph-tool windows as well as the query-tree, data-collector, and activity tools.

The graph-tool windows have no hierarchy; you can create and close these windows in any order.

Graph tool

The graph tool is the principal **onperf** interface. Use the graph tool to display any set of database server metrics that the **onperf** data collector obtains from shared memory.

The Figure 14-5 shows a diagram of a graph tool that displays a graph of metrics for ISAM calls.

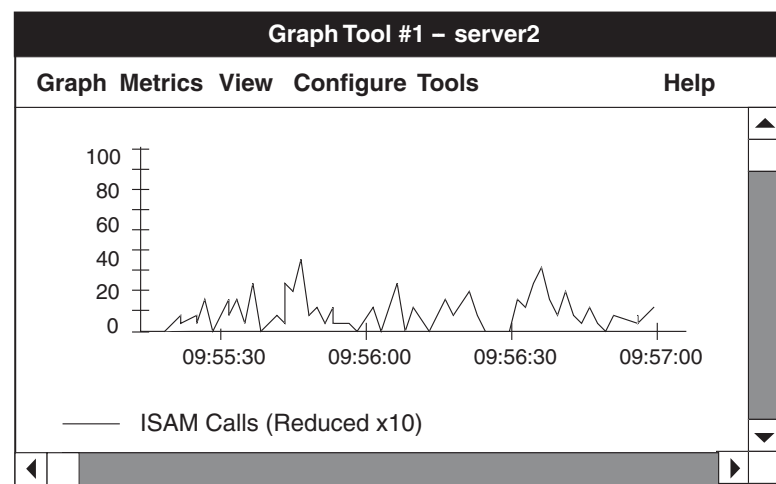

Figure 14-5. Graph-Tool window

You cannot bring up a graph-tool window from a query-tree tool, a status tool, or one of the activity tools.

Graph-tool title bar

When you invoke **onperf**, the initial graph-tool window displays **serverName**, the database server that the **INFORMIXSERVER** environment variable specifies, in the title bar. The data comes from the shared memory of the indicated database server instance.

If the configuration of an initial graph-tool has not yet been saved or loaded from disk, **onperf** does not display the name of a configuration file in the title bar.

If you open a historical data file, for example named **caselog.23April.2PM**, in this graph-tool window, the title bar displays **caselog.23April.23April.2PM**.

Graph-tool graph menu

The **Graph** menu contains options for creating, opening, saving the contents of, printing the contents of, annotating, and closing a graph tool.

The **Graph** menu provides the following options.

Option Use

New Creates a new graph tool. All graph tools that you create using this option share the same data-collector and **onperf** processes. To create new graph tools, use this option rather than invoke **onperf** multiple times.

Open History File

Loads a previously saved file of historical data into the graph tool for viewing. If the file does not exist, **onperf** prompts you for one. When you select a file, **onperf** starts a playback process to view the file.

Save History File

Saves the contents of the data-collector buffer to either an ASCII or a binary file, as specified in the Configuration dialog box.

Save History File As

Specifies the filename in which to save the contents of the data-collector buffer.

Annotate

Brings up a dialog box in which you can enter a header label and a footer label. Each label is optional. The labels are displayed on the graph. When you save the graph configuration, **onperf** includes these labels in the saved configuration file.

Print Brings up a dialog box that allows you to select a destination file. You cannot send the contents of the graph tool directly to a printer; you must use this option to specify a file and subsequently send the file to a printer.

Close Closes the tool. When a tool is the last remaining tool of the **onperf** session, this menu item behaves in the same way as the **Exit** option.

Exit Exits **onperf**.

Important: To save your current configuration before you load a new configuration from a file, you must choose **Configure > Save Configuration** or **Configure > Save Configuration As**.

Graph-tool metrics menu

The **Metrics** menu contains options for choosing the class of metrics to display in the graph tool.

Metrics are organized by *class* and *scope*. When you select a metric for the graph tool to display, you must specify the metric class, the metric scope, and the name of the metric.

The *metric class* is the generic database server component or activity that the metric monitors. The *metric scope* depends on the metric class. In some cases, the metric scope indicates a particular component or activity. In other cases, the scope indicates all activities of a given type across an instance of the database server.

The **Metrics** menu has a separate option for each class of metrics. For more information about metrics, see “Why you might want to use onperf” on page 14-12.

When you choose a class, such as **Server**, you see a dialog box like the one in Figure 14-6.

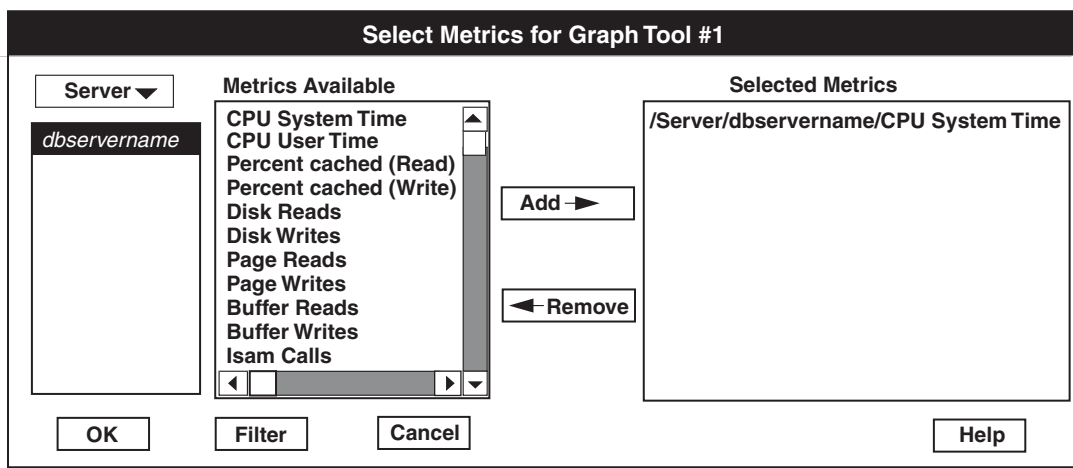

Figure 14-6. The Select Metrics dialog box

The Select Metrics dialog box contains three list boxes. The list box on the left displays the valid scope levels for the selected metrics class. For example, when the scope is set to **Server**, the list box displays the dbservername of the database server instance that is being monitored. When you select a scope from this list, **onperf** displays the individual metrics that are available within that scope in the middle list box. You can select one or more individual metrics from this list and add them to the display by clicking **Add**. To remove them from the display, click **Remove**.

Tip: You can display metrics from more than one class in a single graph-tool window. For example, you might first select **ISAM Calls**, **Opens**, and **Starts** from the **Server** class. When you choose the **Option** menu in the same dialog box, you can select another metric class without exiting the dialog box. For example, you might select the Chunks metric class and add the **Operations**, **Reads**, and **Writes** metrics to the display.

The **Filter** button in the dialog box brings up an additional dialog box in which you can filter long text strings shown in the Metrics dialog box. The Filter dialog box also lets you select tables or fragments for which metrics are not currently displayed.

After you make your selections, you can click OK to proceed, or Cancel if you choose not to proceed.

Graph-tool view menu

The **View** menu contains options for changing how the graph tool appears.

The **View** menu provides the following options.

Line Changes the graph tool to the line format. Line format includes horizontal and vertical scroll bars. The vertical scroll bar adjusts the scale of the horizontal time axis. When you raise this bar, **onperf** reduces the scale and vice versa. The horizontal scroll bar allows you to adjust your view along the horizontal time axis.

To change the color and width of the lines in the line format, click the legend in the graph tool. When you do, **onperf** generates a Customize Metric dialog box that provides a choice of line color and width.

Horizontal Bar Graph

Changes the graph tool to the horizontal bar format.

Vertical Bar Graph

Changes the graph tool to the vertical bar format.

Pie Changes the graph tool to the pie-chart format. To display a pie chart, you must select at least two metrics.

Quick Rescale Axis

Rescales the axis to the largest point that is currently visible on the graph. This button turns off automatic rescaling.

Configure Axis

Displays the Axis Configuration dialog box. Use this dialog box to select a fixed value for the y-axis on the graph or select automatic axis scaling.

The graph-tool Configure menu and the Configuration dialog box

The **Configure** menu contains options of opening, editing, and saving **onperf** configuration information.

The **Configure** menu provides the following options.

Edit Configuration

Brings up the Configuration dialog box, which allows you to change the settings for the current data-collector buffer, graph-tool display options, and data-collector options. The Configuration dialog box appears in Figure 14-7 on page 14-9.

Open Configuration

Restarts **onperf** with the settings that are stored in the configuration file. Unsaved data in the data-collector buffer is lost. If no configuration file is specified and the default does not exist, the following error message appears:

```
Open file filename failed.
```

If the specified configuration file does not exist, **onperf** prompts for one.

Save Configuration

Saves the current configuration to a file. If no configuration file is currently specified, **onperf** prompts for one.

Save Configuration As

Saves a configuration file. This option always prompts for a filename.

To configure data-collector options, graph-display options, and metrics about which to collect data, choose the **Edit Configuration** option to bring up the Configuration dialog box.

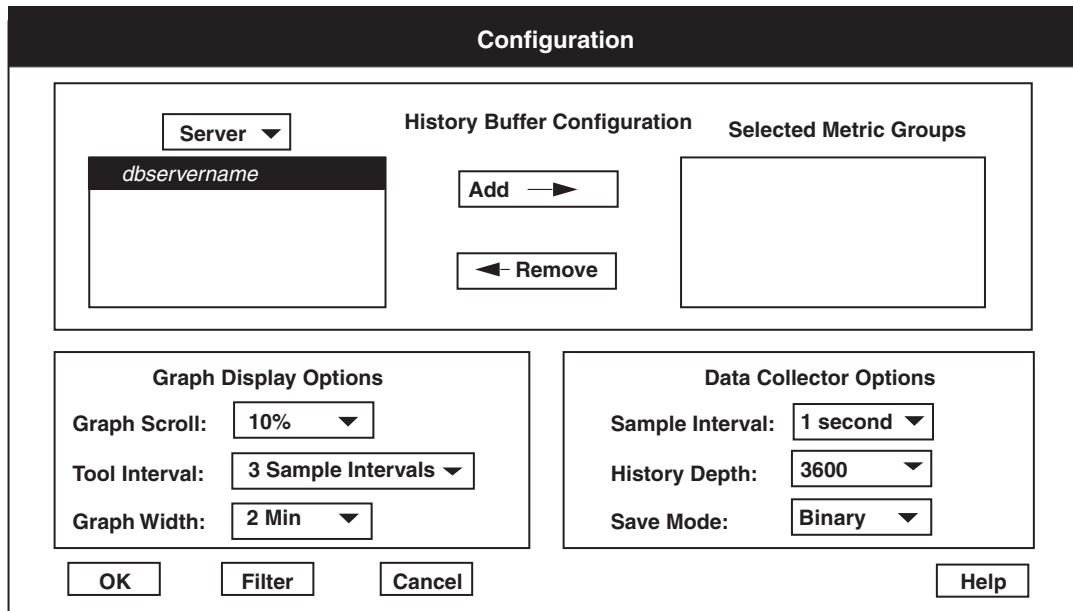

Figure 14-7. The Configuration dialog box

The Configuration dialog box provides the following options for configuring display.

Option Use

History Buffer Configuration

Allows you to select a metric class and metric scope to include in the data-collector buffer. The data collector gathers information about all metrics that belong to the indicated class and scope.

Graph Display Options

Allows you to adjust the size of the graph portion that scrolls off to the left when the display reaches the right edge, the initial time interval that the graph is to span, and the frequency with which the display is updated.

Data Collector Options

Controls the collection of data. The sample interval indicates the amount of time to wait between recorded samples. The history depth indicates the number of samples to retain in the data-collector buffer. The save mode indicates the data-collector data should be saved in binary or ASCII format.

Graph-tool Tools menu

The **Tools** menu contains options that start additional **onperf** tools.

This menu provides the following options.

Query Tree

Starts a query-tree tool. For more information, see “Query-tree tool” on page 14-11.

Status Starts a status tool. For more information, see “Status tool” on page 14-11.

Disk Activity

Starts a disk-activity tool. For more information, see “Activity tools” on page 14-12.

Session Activity

Starts a session-activity tool. For more information, see “Activity tools” on page 14-12.

Disk Capacity

Starts a disk-capacity tool. For more information, see “Activity tools” on page 14-12.

Physical Processor Activity

Starts a physical-processor tool. For more information, see “Activity tools” on page 14-12.

Virtual Processor Activity

Starts a virtual-processor tool. For more information, see “Activity tools” on page 14-12.

Changing the scale of metrics

When **onperf** displays metrics, it automatically adjusts the scale of the y-axis to accommodate the largest value. You can use the Customize Metric dialog box to establish one for the current display.

For more information, see “Graph-tool view menu” on page 14-8.

Displaying recent-history values

When you use the **onperf** utility, you can scroll back over previous metric values that are displayed in a line graph. This is useful for analyzing recent trends.

The time interval to which you can scroll back is the *lesser* of the following intervals:

- The time interval over which the metric has been displayed
 - The history interval that the graph-tool Configuration dialog box specifies
- The length of time you can scroll back through cannot exceed the depth of the data-collector buffer.

For more information, see “The graph-tool Configure menu and the Configuration dialog box” on page 14-8.

Figure 14-8 on page 14-11 illustrates the maximum scrollable intervals for metrics that span different time periods.

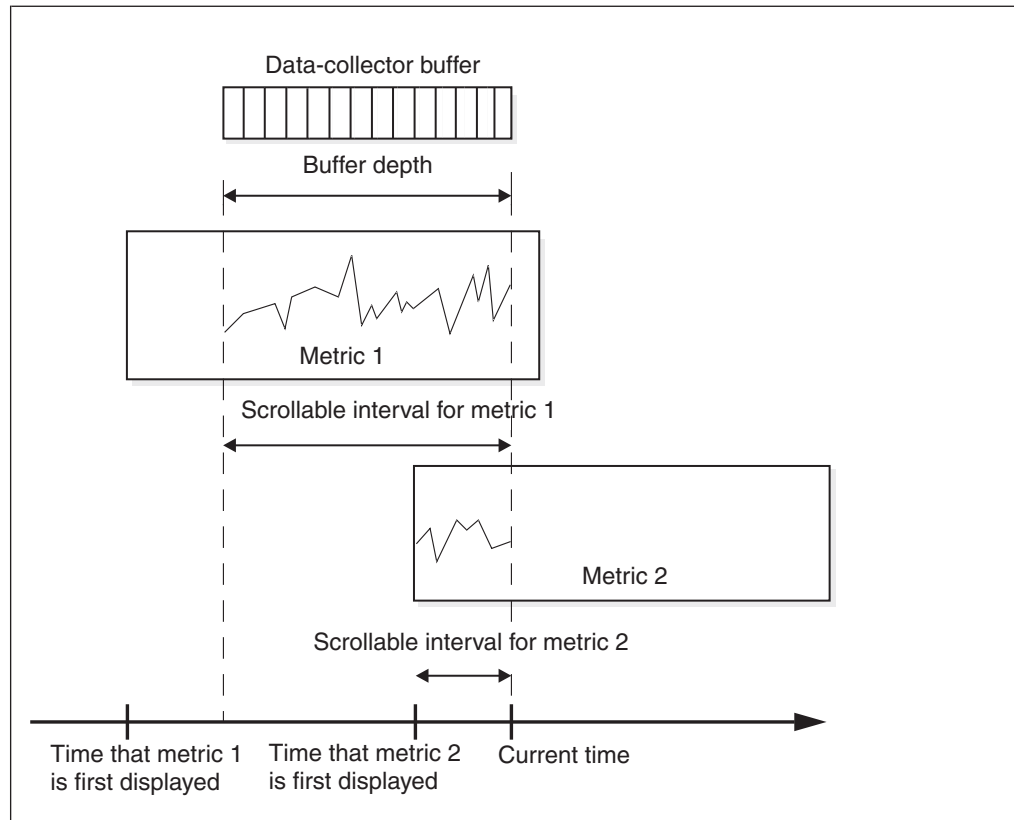

Figure 14-8. Maximum scrollable intervals for metrics that span different time periods

Query-tree tool

The query-tree tool contains options for monitoring the performance of individual queries.

The query-tree tool is a separate executable tool that does not use the data-collector process. You cannot save query-tree tool data to a file.

This tool includes a **Select Session** button and a **Quit** button. When you select a session that is running a query, the large detail window displays the SQL operators that constitute the execution plan for the query. The query-tree tool represents each SQL operator with a box. Each box includes a dial that indicates rows per second and a number that indicates input rows. In some cases, not all the SQL operators can be represented in the detail window. The smaller window shows the SQL operators as small icons.

The **Quit** button allows you to exit from the query-tree tool.

Status tool

The status tool enables you to select metrics to store in the data-collector buffer. In addition, you can use this tool to save the data currently held in the data-collector buffer to a file.

Figure 14-9 on page 14-12 shows a status tool.

The status tool displays:

- The length of time that the data collector has been running
 - The size of the data-collector process area, called the *collector virtual memory size*
- When you select different metrics to store in the data-collector buffer, you see different values for the collector virtual memory size.

Status Tool	
File	Tools
	Help
Server:	Dynamic Server, Running 0:52:25
Shared memory size:	1.45 MB
Data Collector:	Running 0:03:38
Collector virtual memory size:	0.63 MB

Figure 14-9. Status Tool window

The status tool **File** menu provides the following options.

Option Use

Close This option closes the tool. When it is the last remaining tool of the **onperf** session, Close behaves in the same way as Exit.

Exit This option exits **onperf**.

Activity tools

Activity tools are specialized forms of the graph tool that display instances of the specific activity, based on a ranking of the activity by some suitable metric.

You can choose from among the following activity tools:

- The disk-activity tool, which displays the top 10 activities ranked by total operations
- The session-activity tool, which displays the top 10 activities ranked by ISAM calls plus PDQ calls per second
- The disk-capacity tool, which displays the top 10 activities ranked by free space in megabytes
- The physical-processor-activity tool, which displays all processors ranked by nonidle CPU time
- The virtual-processor-activity tool, which displays all VPs ranked by VP user time plus VP system time

The activity tools use the bar-graph format. You cannot change the scale of an activity tool manually; **onperf** always sets this value automatically.

The **Graph** menu provides you with options for closing, printing, and exiting the activity tool.

Why you might want to use onperf

You can use the **onperf** utility for routine monitoring, diagnosing sudden performance loss, and diagnosing performance degradation.

The following sections provide suggestions for different ways to use the **onperf** utility.

Routine monitoring with onperf

You can use the **onperf** utility to facilitate routine monitoring. For example, you can display several metrics in a graph-tool window and run this tool throughout the day.

Displaying these metrics allows you to monitor database server performance visually at any time.

Diagnosing sudden performance loss

When you detect a sudden performance dip, you can use the **onperf** utility to examine the recent history of the database server metrics values to identify any trend.

The **onperf** utility allows you to scroll back over a time interval, as explained in “Displaying recent-history values” on page 14-10.

Diagnosing performance degradation

You can save the metrics that the **onperf** utility displays, so you can analyze it and compare it to other saved information. This can be useful when analyzing performance problems that gradually develop and might be difficult to diagnose.

For example, if you detect a degradation in database server response time, it might not be obvious from looking at the current metrics which value is responsible for the slowdown. The performance degradation might also be sufficiently gradual that you cannot detect a change by observing the recent history of metric values. To allow for comparisons over longer intervals, **onperf** allows you to save metric values to a file, as explained in “Status tool” on page 14-11.

onperf utility metrics

When you use the **onperf** utility, you can view various metric classes.

The following sections describe these metric classes. Each section indicates the scope levels available and describes the metrics within each class.

Database server performance depends on many factors, including the operating-system configuration, the database server configuration, and the workload. It is difficult to describe relationships between **onperf** metrics and specific performance characteristics.

The approach taken here is to describe each metric without speculating on what specific performance problems it might indicate. Through experimentation, you can determine which metrics best monitor performance for a specific database server instance.

Database server metrics

The **onperf** utility displays metrics for the named database server, rather than a component of the database server or disk space.

The **onperf** utility displays the following database server metrics.

Metric Name	Description
CPU System Time	System time, as defined by the platform vendor
CPU User Time	User time, as defined by the platform vendor
Percent Cached (Read)	Percentage of all read operations that are read from the buffer cache without requiring a disk read, calculated as follows: $100 * ((\text{buffer_reads} - \text{disk_reads}) / (\text{buffer_reads}))$
Percent Cached (Write)	Percentage of all write operations that are buffer writes, calculated as follows: $100 * ((\text{buffer_writes} - \text{disk_writes}) / (\text{buffer_writes}))$
Disk Reads	Total number of read operations from disk
Disk Writes	Total number of write operations to disk
Page Reads	Number of pages read from disk
Page Writes	Number of pages transferred to disk
Buffer Reads	Number of reads from the buffer cache
Buffer Writes	Number of writes to the buffer cache
Calls	Number of calls received at the database server
Reads	Number of read calls received at the database server
Writes	Number of write calls received at the database server
Rewrites	Number of rewrite calls received at the database server
Deletes	Number of delete calls received at the database server
Commits	Number of commit calls received at the database server
Rollbacks	Number of rollback calls received at the database server
Table Overflows	Number of times that the tblspace table was unavailable (overflowed)
Lock Overflows	Number of times that the lock table was unavailable (overflowed)
User Overflows	Number of times that the user table was unavailable (overflowed)
Checkpoints	Number of checkpoints written since database server shared memory began
Buffer Waits	Number of times that a thread waited to access a buffer
Lock Waits	Number of times that a thread waited for a lock
Lock Requests	Number of times that a lock was requested
Deadlocks	Number of deadlocks detected
Deadlock Timeouts	Number of deadlock timeouts that occurred (Deadlock timeouts involve distributed transactions.)
Checkpoint Waits	Number of checkpoint waits; in other words, the number of times that threads have waited for a checkpoint to complete
Index to Data Pages Read-aheads	Number of read-ahead operations for index keys
Index Leaves Read-aheads	Number of read-ahead operations for index leaf nodes
Data-path-only Read-aheads	Number of read-ahead operations for data pages
Latch Requests	Number of latch requests

Metric Name	Description
Network Reads	Number of ASF messages read
Network Writes	Number of ASF messages written
Memory Allocated	Amount of database server virtual-address space in kilobytes
Memory Used	Amount of database server shared memory in kilobytes
Temp Space Used	Amount of shared memory allocated for temporary tables in kilobytes
PDQ Calls	The total number of parallel-processing actions that the database server performed
DSS Memory	Amount of memory currently in use for decision-support queries

Disk-chunk metrics

The **onperf** utility can display metrics for a specific disk chunk.

The disk-chunk metrics take the path name of a chunk as the metric scope.

Metric Name	Description
Disk Operations	Total number of I/O operations to or from the indicated chunk
Disk Reads	Total number of reads from the chunk
Disk Writes	Total number of writes to the chunk
Free Space (MB)	The amount of free space available in megabytes

Disk-spindle metrics

The **onperf** utility can display metrics for a disk spindle.

The disk-spindle metrics take the path name of a disk device or operation-system file as the metric scope.

Metric Name	Description
Disk Operations	Total number of I/O operations to or from the indicated disk or buffered operating-system file
Disk Reads	Total number of reads from the disk or operating-system file
Disk Writes	Total number of writes to the disk or operating-system file
Free Space	The amount of free space available in megabytes

Physical-processor metrics

The **onperf** utility can display CPU metrics.

The physical-processor metrics take either a physical-processor identifier (for example, 0 or 1) or **Total** as the metric scope.

Metric Name	Description
Percent CPU System Time	CPU system time for the physical processors
Percent CPU User Time	CPU user time for the physical processors
Percent CPU Idle Time	CPU idle time for the physical processors

Metric Name	Description
Percent CPU Time	The sum of CPU system time and CPU user time for the physical processors

Virtual-processor metrics

The **onperf** utility can display metrics for a virtual-processor class.

These metrics take a virtual-processor class as a metric scope (cpu, aio, kaio, and so on). Each metric value represents a sum across all instances of this virtual-processor class.

Metric Name	Description
User Time	Accumulated user time for a class
System Time	Accumulated system time for a class
Semaphore Operations	Total count of semaphore operations
Busy Waits	Number of times that virtual processors in class avoided a context switch by spinning in a loop before going to sleep
Spins	Number of times through the loop
I/O Operations	Number of I/O operations per second
I/O Reads	Number of read operations per second
I/O Writes	Number of write operations per second

Session metrics

The **onperf** utility can display metrics for an active session.

These metrics take the active session as the metric scope.

Metric Name	Description
Page Reads	Number of pages read from disk on behalf of a session
Page Writes	Number of pages written to disk on behalf of a session
Number of Threads	Number of threads currently running for the session
Lock Requests	Number of lock requests issued by the session
Lock Waits	Number of lock waits for session threads
Deadlocks	Number of deadlocks involving threads that belong to the session
Deadlock timeouts	Number of deadlock timeouts involving threads that belong to the session
Log Records	Number of log records written by the session
ISAM Calls	Number of ISAM calls by session
ISAM Reads	Number of ISAM read calls by session
ISAM Writes	Number of ISAM write calls by session
ISAM Rewrites	Number of ISAM rewrite calls by session
ISAM Deletes	Number of ISAM delete calls by session
ISAM Commits	Number of ISAM commit calls by session
ISAM Rollbacks	Number of ISAM rollback calls by session

Metric Name	Description
Long Transactions	Number of long transactions owned by session
Buffer Reads	Number of buffer reads performed by session
Buffer Writes	Number of buffer writes performed by session
Log Space Used	Amount of logical-log space used
Maximum Log Space Used	High-watermark of logical-log space used for this session
Sequential Scans	Number of sequential scans initiated by session
PDQ Calls	Number of parallel-processing actions performed for queries initiated by the session
Memory Allocated	Memory allocated for the session in kilobytes
Memory Used	Memory used by the session in kilobytes

Tblspace metrics

The **onperf** utility can display metrics for a particular tblspace.

A tblspace name is composed of the database name, a colon, and the table name (*database:table*).

For fragmented tables, the tblspace represents the sum of all fragments in a table. To obtain measurements for an individual fragment in a fragmented table, use the Fragment Metric class.

Metric Name	Description
Lock Requests	Total requests to lock tblspace
Lock Waits	Number of times that threads waited to obtain a lock for the tblspace
Deadlocks	Number of times that a deadlock involved the tblspace
Deadlock Timeouts	Number of times that a deadlock timeout involved the tblspace
Reads	Number of read calls that involve the tblspace
Writes	Number of write calls that involve the tblspace
Rewrites	Number of rewrite calls that involve the tblspace
Deletes	Number of delete calls that involve the tblspace
Calls	Total calls that involve the tblspace
Buffer Reads	Number of buffer reads that involve tblspace data
Buffer Writes	Number of buffer writes that involve tblspace data
Sequential Scans	Number of sequential scans of the tblspace
Percent Free Space	Percent of the tblspace that is free
Pages Allocated	Number of pages allocated to the tblspace
Pages Used	Number of pages allocated to the tblspace that have been written
Data Pages	Number of pages allocated to the tblspace that are used as data pages

Fragment metrics

The **onperf** utility can display metrics for an individual table fragment.

These metrics take the dbspace of an individual table fragment as the metric scope.

Metric Name	Description
Lock Requests	Total requests to lock fragment
Lock Waits	Number of times that threads have waited to obtain a lock for the fragment
Deadlocks	Number of times that a deadlock involved the fragment
Deadlock Timeouts	Number of times that a deadlock timeout involved the fragment
Reads	Number of read calls that involve the fragment
Writes	Number of write calls that involve the fragment
Rewrites	Number of rewrite calls that involve the fragment
Deletes	Number of delete calls that involve the fragment
Calls	Total calls that involve the fragment
Buffer Reads	Number of buffer reads that involve fragment data
Buffer Writes	Number of buffer writes that involve fragment data
Sequential Scans	Number of sequential scans of the fragment
Percent Free Space	Percent of the fragment that is free
Pages Allocated	Number of pages allocated to the fragment
Pages Used	Number of pages allocated to the fragment that have been written to
Data Pages	Number of pages allocated to the fragment that are used as data pages

Appendix A. Case studies and examples

This appendix contains a case study with examples of performance-tuning methods that this publication describes.

Case study of a situation in which disks are overloaded

You can identify overloaded disks and the dbspaces that reside on those disks. After you do this, you can correct the problem.

The following case study illustrates a situation in which the disks are overloaded. It shows the steps taken to isolate the symptoms and identify the problem based on an initial report from a user, and it describes the needed correction.

A database application that has not achieved the desired throughput is being examined to see how performance can be improved. The operating-system monitoring tools reveal that a high proportion of process time was spent idle, waiting for I/O. The database server administrator increases the number of CPU VPs to make more processors available to handle concurrent I/O. However, throughput does not increase, which indicates that one or more disks are overloaded.

To verify the I/O bottleneck, the database server administrator must identify the overloaded disks and the dbspaces that reside on those disks.

To identify overloaded disks and the dbspaces that reside on those disks:

1. To check the asynchronous I/O (AIO) queues, use `onstat -g ioq`. Figure A-1 shows the output.

```
AIO I/O queues:
q name/id    len maxlen totalops  dskread dskwrite  dskcopy
opt  0        0      0        0         0         0         0
msc  0        0      0        0         0         0         0
aio  0        0      0        0         0         0         0
pio  0        0      1         1         0         1         0
lio  0        0      1        341        0        341        0
gfd  3        0      1        225         2        223        0
gfd  4        0      1        225         2        223        0
gfd  5        0      1        225         2        223        0
gfd  6        0      1        225         2        223        0
gfd  7        0      0         0         0         0         0
gfd  8        0      0         0         0         0         0
gfd  9        0      0         0         0         0         0
gfd 10        0      0         0         0         0         0
gfd 11        0      28       32693      29603      3090         0
gfd 12        0      18       32557      29373      3184         0
gfd 13        0      22       20446      18496      1950         0
```

Figure A-1. Output from the `onstat -g ioq` option

In Figure A-1, the **maxlen** and **totalops** columns show significant results:

- The **maxlen** column shows the largest backlog of I/O requests to accumulate within the queue. The last three queues are much longer than any other queue in this column listing.

- The **totalops** column shows 100 times more I/O operations completed through the last three queues than for any other queue in the column listing. The **maxlen** and **totalops** columns indicate that the I/O load is severely unbalanced.

Another way to check I/O activity is to use **onstat -g iof**. This option provides a slightly less detailed display for all VPs.

2. To check the AIO activity for each disk device, use **onstat -g iof**, as Figure A-2 shows.

```
AIO global files:
gfd pathname          totalops  dskread  dskwrite  io/s
3 /dev/infx2           0         0         0         0.0
4 /dev/infx2           0         0         0         0.0
5 /dev/infx2           2         2         0         0.0
6 /dev/infx2          223        0        223        0.5
7 /dev/infx4           0         0         0         0.0
8 /dev/infx4           1         0         1         0.0
9 /dev/infx4          341        0        341        0.7
10 /dev/infx4          0         0         0         0.0
11 /dev/infx5          32692      29602     3090       67.1
12 /dev/infx6          32556      29372     3184       66.9
13 /dev/infx7          20446      18496     1950       42.0
```

Figure A-2. Output from the **onstat -g iof** option

This output indicates the disk device associated with each queue. Depending on how your chunks are arranged, several queues can be associated with the same device. In this case, the total activity for **/dev/infx2** is the sum of the **totalops** column for queues 3, 4, 5, and 6, which is 225 operations. This activity is still insignificant when compared with **/dev/infx5**, **/dev/infx6**, and **/dev/infx7**.

3. To determine the dbspaces that account for the I/O load, use **onstat -d**, as Figure A-3 on page A-3 shows.

```

Dbspaces
address number  flags  fchunk  nchunks  flags  owner  name
c009ad00 1      1      1        1        N      informix rootdbs
c009ad44 2     2001    2         1        N T    informix tmp1dbs
c009ad88 3      1      3         1        N      informix oltpdbs
c009adcc 4      1      4         1        N      informix histdbs
c009ae10 5     2001    5         1        N T    informix tmp2dbs
c009ae54 6      1      6         1        N      informix physdbs
c009ae98 7      1      7         1        N      informix logidbs
c009aedc 8      1      8         1        N      informix runsdbs
c009af20 9      1      9         3        N      informix acctdbs
9 active, 32 total

Chunks
address  chk/dbs  offset  size  free  bpages  flags  pathname
c0099574 1 1 500000 10000 9100  PO-  /dev/infx2
c009960c 2 2 510000 10000 9947  PO-  /dev/infx2
c00996a4 3 3 520000 10000 9472  PO-  /dev/infx2
c009973c 4 4 530000 250000 242492  PO-  /dev/infx2
c00997d4 5 5 500000 10000 9947  PO-  /dev/infx4
c009986c 6 6 510000 10000 2792  PO-  /dev/infx4
c0099904 7 7 520000 25000 11992  PO-  /dev/infx4
c009999c 8 8 545000 10000 9536  PO-  /dev/infx4
c0099a34 9 9 250000 450000 4947  PO-  /dev/infx5
c0099acc 10 9 250000 450000 4997  PO-  /dev/infx6
c0099b64 11 9 250000 450000 169997  PO-  /dev/infx7
11 active, 32 total

```

Figure A-3. Display from the `onstat -d` option

In the **Chunks** output, the **pathname** column indicates the disk device. The **chk/dbs** column indicates the numbers of the chunk and dbspace that reside on each disk. In this case, only one chunk is defined on each of the overloaded disks. Each chunk is associated with dbspace number 9.

The **Dbspaces** output shows the name of the dbspace that is associated with each dbspace number. In this case, all three of the overloaded disks are part of the **acctdbs** dbspace.

Although the original disk configuration allocated three entire disks to the **acctdbs** dbspace, the activity within this dbspace suggests that three disks are not enough. Because the load is about equal across the three disks, it does not appear that the tables are necessarily laid out badly or improperly fragmented. However, you could get better performance by adding fragments on other disks to one or more large tables in this dbspace or by moving some tables to other disks with lighter loads.

Appendix B. Accessibility

IBM strives to provide products with usable access for everyone, regardless of age or ability.

Accessibility features for IBM Informix products

Accessibility features help a user who has a physical disability, such as restricted mobility or limited vision, to use information technology products successfully.

Accessibility features

The following list includes the major accessibility features in IBM Informix products. These features support:

- Keyboard-only operation.
- Interfaces that are commonly used by screen readers.
- The attachment of alternative input and output devices.

Tip: The information center and its related publications are accessibility-enabled for the IBM Home Page Reader. You can operate all features by using the keyboard instead of the mouse.

Keyboard navigation

This product uses standard Microsoft Windows navigation keys.

Related accessibility information

IBM is committed to making our documentation accessible to persons with disabilities. Our publications are available in HTML format so that they can be accessed with assistive technology such as screen reader software.

You can view the publications in Adobe Portable Document Format (PDF) by using the Adobe Acrobat Reader.

IBM and accessibility

See the *IBM Accessibility Center* at <http://www.ibm.com/able> for more information about the IBM commitment to accessibility.

Dotted decimal syntax diagrams

The syntax diagrams in our publications are available in dotted decimal format, which is an accessible format that is available only if you are using a screen reader.

In dotted decimal format, each syntax element is written on a separate line. If two or more syntax elements are always present together (or always absent together), the elements can appear on the same line, because they can be considered as a single compound syntax element.

Each line starts with a dotted decimal number; for example, 3 or 3.1 or 3.1.1. To hear these numbers correctly, make sure that your screen reader is set to read punctuation. All syntax elements that have the same dotted decimal number (for example, all syntax elements that have the number 3.1) are mutually exclusive

alternatives. If you hear the lines 3.1 USERID and 3.1 SYSTEMID, your syntax can include either USERID or SYSTEMID, but not both.

The dotted decimal numbering level denotes the level of nesting. For example, if a syntax element with dotted decimal number 3 is followed by a series of syntax elements with dotted decimal number 3.1, all the syntax elements numbered 3.1 are subordinate to the syntax element numbered 3.

Certain words and symbols are used next to the dotted decimal numbers to add information about the syntax elements. Occasionally, these words and symbols might occur at the beginning of the element itself. For ease of identification, if the word or symbol is a part of the syntax element, the word or symbol is preceded by the backslash (\) character. The * symbol can be used next to a dotted decimal number to indicate that the syntax element repeats. For example, syntax element *FILE with dotted decimal number 3 is read as 3 * FILE. Format 3* FILE indicates that syntax element FILE repeats. Format 3* * FILE indicates that syntax element * FILE repeats.

Characters such as commas, which are used to separate a string of syntax elements, are shown in the syntax just before the items they separate. These characters can appear on the same line as each item, or on a separate line with the same dotted decimal number as the relevant items. The line can also show another symbol that provides information about the syntax elements. For example, the lines 5.1*, 5.1 LASTRUN, and 5.1 DELETE mean that if you use more than one of the LASTRUN and DELETE syntax elements, the elements must be separated by a comma. If no separator is given, assume that you use a blank to separate each syntax element.

If a syntax element is preceded by the % symbol, that element is defined elsewhere. The string following the % symbol is the name of a syntax fragment rather than a literal. For example, the line 2.1 %OP1 refers to a separate syntax fragment OP1.

The following words and symbols are used next to the dotted decimal numbers:

- ? Specifies an optional syntax element. A dotted decimal number followed by the ? symbol indicates that all the syntax elements with a corresponding dotted decimal number, and any subordinate syntax elements, are optional. If there is only one syntax element with a dotted decimal number, the ? symbol is displayed on the same line as the syntax element (for example, 5? NOTIFY). If there is more than one syntax element with a dotted decimal number, the ? symbol is displayed on a line by itself, followed by the syntax elements that are optional. For example, if you hear the lines 5 ?, 5 NOTIFY, and 5 UPDATE, you know that syntax elements NOTIFY and UPDATE are optional; that is, you can choose one or none of them. The ? symbol is equivalent to a bypass line in a railroad diagram.
- ! Specifies a default syntax element. A dotted decimal number followed by the ! symbol and a syntax element indicates that the syntax element is the default option for all syntax elements that share the same dotted decimal number. Only one of the syntax elements that share the same dotted decimal number can specify a ! symbol. For example, if you hear the lines 2? FILE, 2.1! (KEEP), and 2.1 (DELETE), you know that (KEEP) is the default option for the FILE keyword. In this example, if you include the FILE keyword but do not specify an option, default option KEEP is applied. A default option also applies to the next higher dotted decimal number. In this example, if the FILE keyword is omitted, default FILE(KEEP) is used.

However, if you hear the lines 2? FILE, 2.1, 2.1.1! (KEEP), and 2.1.1 (DELETE), the default option KEEP only applies to the next higher dotted decimal number, 2.1 (which does not have an associated keyword), and does not apply to 2? FILE. Nothing is used if the keyword FILE is omitted.

- * Specifies a syntax element that can be repeated zero or more times. A dotted decimal number followed by the * symbol indicates that this syntax element can be used zero or more times; that is, it is optional and can be repeated. For example, if you hear the line 5.1* data-area, you know that you can include more than one data area or you can include none. If you hear the lines 3*, 3 HOST, and 3 STATE, you know that you can include HOST, STATE, both together, or nothing.

Notes:

1. If a dotted decimal number has an asterisk (*) next to it and there is only one item with that dotted decimal number, you can repeat that same item more than once.
2. If a dotted decimal number has an asterisk next to it and several items have that dotted decimal number, you can use more than one item from the list, but you cannot use the items more than once each. In the previous example, you can write HOST STATE, but you cannot write HOST HOST.
3. The * symbol is equivalent to a loop-back line in a railroad syntax diagram.

- + Specifies a syntax element that must be included one or more times. A dotted decimal number followed by the + symbol indicates that this syntax element must be included one or more times. For example, if you hear the line 6.1+ data-area, you must include at least one data area. If you hear the lines 2+, 2 HOST, and 2 STATE, you know that you must include HOST, STATE, or both. As for the * symbol, you can repeat a particular item if it is the only item with that dotted decimal number. The + symbol, like the * symbol, is equivalent to a loop-back line in a railroad syntax diagram.

Notices

This information was developed for products and services offered in the U.S.A.

IBM may not offer the products, services, or features discussed in this document in other countries. Consult your local IBM representative for information on the products and services currently available in your area. Any reference to an IBM product, program, or service is not intended to state or imply that only that IBM product, program, or service may be used. Any functionally equivalent product, program, or service that does not infringe any IBM intellectual property right may be used instead. However, it is the user's responsibility to evaluate and verify the operation of any non-IBM product, program, or service.

IBM may have patents or pending patent applications covering subject matter described in this document. The furnishing of this document does not grant you any license to these patents. You can send license inquiries, in writing, to:

IBM Director of Licensing
IBM Corporation
North Castle Drive
Armonk, NY 10504-1785
U.S.A.

For license inquiries regarding double-byte (DBCS) information, contact the IBM Intellectual Property Department in your country or send inquiries, in writing, to:

Intellectual Property Licensing
Legal and Intellectual Property Law
IBM Japan Ltd.
1623-14, Shimotsuruma, Yamato-shi
Kanagawa 242-8502 Japan

The following paragraph does not apply to the United Kingdom or any other country where such provisions are inconsistent with local law: INTERNATIONAL BUSINESS MACHINES CORPORATION PROVIDES THIS PUBLICATION "AS IS" WITHOUT WARRANTY OF ANY KIND, EITHER EXPRESS OR IMPLIED, INCLUDING, BUT NOT LIMITED TO, THE IMPLIED WARRANTIES OF NON-INFRINGEMENT, MERCHANTABILITY OR FITNESS FOR A PARTICULAR PURPOSE. Some states do not allow disclaimer of express or implied warranties in certain transactions, therefore, this statement may not apply to you.

This information could include technical inaccuracies or typographical errors. Changes are periodically made to the information herein; these changes will be incorporated in new editions of the publication. IBM may make improvements and/or changes in the product(s) and/or the program(s) described in this publication at any time without notice.

Any references in this information to non-IBM websites are provided for convenience only and do not in any manner serve as an endorsement of those websites. The materials at those websites are not part of the materials for this IBM product and use of those websites is at your own risk.

IBM may use or distribute any of the information you supply in any way it believes appropriate without incurring any obligation to you.

Licensees of this program who wish to have information about it for the purpose of enabling: (i) the exchange of information between independently created programs and other programs (including this one) and (ii) the mutual use of the information which has been exchanged, should contact:

IBM Corporation
J46A/G4
555 Bailey Avenue
San Jose, CA 95141-1003
U.S.A.

Such information may be available, subject to appropriate terms and conditions, including in some cases, payment of a fee.

The licensed program described in this document and all licensed material available for it are provided by IBM under terms of the IBM Customer Agreement, IBM International Program License Agreement or any equivalent agreement between us.

Any performance data contained herein was determined in a controlled environment. Therefore, the results obtained in other operating environments may vary significantly. Some measurements may have been made on development-level systems and there is no guarantee that these measurements will be the same on generally available systems. Furthermore, some measurements may have been estimated through extrapolation. Actual results may vary. Users of this document should verify the applicable data for their specific environment.

Information concerning non-IBM products was obtained from the suppliers of those products, their published announcements or other publicly available sources. IBM has not tested those products and cannot confirm the accuracy of performance, compatibility or any other claims related to non-IBM products. Questions on the capabilities of non-IBM products should be addressed to the suppliers of those products.

All statements regarding IBM's future direction or intent are subject to change or withdrawal without notice, and represent goals and objectives only.

All IBM prices shown are IBM's suggested retail prices, are current and are subject to change without notice. Dealer prices may vary.

This information is for planning purposes only. The information herein is subject to change before the products described become available.

This information contains examples of data and reports used in daily business operations. To illustrate them as completely as possible, the examples include the names of individuals, companies, brands, and products. All of these names are fictitious and any similarity to the names and addresses used by an actual business enterprise is entirely coincidental.

COPYRIGHT LICENSE:

This information contains sample application programs in source language, which illustrate programming techniques on various operating platforms. You may copy,

modify, and distribute these sample programs in any form without payment to IBM, for the purposes of developing, using, marketing or distributing application programs conforming to the application programming interface for the operating platform for which the sample programs are written. These examples have not been thoroughly tested under all conditions. IBM, therefore, cannot guarantee or imply reliability, serviceability, or function of these programs. The sample programs are provided "AS IS", without warranty of any kind. IBM shall not be liable for any damages arising out of your use of the sample programs.

Each copy or any portion of these sample programs or any derivative work, must include a copyright notice as follows:

© (your company name) (year). Portions of this code are derived from IBM Corp. Sample Programs.

© Copyright IBM Corp. _enter the year or years_. All rights reserved.

If you are viewing this information softcopy, the photographs and color illustrations may not appear.

Trademarks

IBM, the IBM logo, and [ibm.com](http://www.ibm.com) are trademarks or registered trademarks of International Business Machines Corp., registered in many jurisdictions worldwide. Other product and service names might be trademarks of IBM or other companies. A current list of IBM trademarks is available on the web at "Copyright and trademark information" at <http://www.ibm.com/legal/copytrade.shtml>.

Adobe, the Adobe logo, and PostScript are either registered trademarks or trademarks of Adobe Systems Incorporated in the United States, and/or other countries.

Intel, Itanium, and Pentium are trademarks or registered trademarks of Intel Corporation or its subsidiaries in the United States and other countries.

Java and all Java-based trademarks and logos are trademarks or registered trademarks of Oracle and/or its affiliates.

Linux is a registered trademark of Linus Torvalds in the United States, other countries, or both.

Microsoft, Windows, and Windows NT are trademarks of Microsoft Corporation in the United States, other countries, or both.

UNIX is a registered trademark of The Open Group in the United States and other countries.

Other company, product, or service names may be trademarks or service marks of others.

Index

Special characters

\$INFORMIXDIR/bin directory 14-4
\$INFORMIXDIR/help directory 14-4

Numerics

64-bit addressing
 buffers 4-13
 tuning RESIDENT configuration parameter 4-19

A

Access method
 ANSI-compliant name 7-18
 directives 11-4
 list 7-16
 secondary 7-16, 7-20

Access plan
 defined 10-1
 directives 11-4
 effects of OPTCOMPIND 10-21
 SET EXPLAIN output 10-12, 12-19
 subquery 10-14

Accessibility B-1
 dotted decimal format of syntax diagrams B-1
 keyboard B-1
 shortcut keys B-1
 syntax diagrams, reading in a screen reader B-1

Activity tools (onperf)
 defined 14-3
 onperf, using 14-12

ADTERR configuration parameter 5-45

ADTMODE configuration parameter 5-45

Affinity
 setting for processor 3-7
 VPCLASS configuration parameter 3-6

AIO
 queues A-1
 virtual processors
 monitoring 3-21
 VPs 3-8

Algorithm, in-place alter 6-27, 10-26

Alice scan mode 13-21, 13-24

ALTER FRAGMENT statement
 eliminating index build during DETACH 9-25, 9-26
 least-cost index build during ATTACH 9-19, 9-20, 9-22, 9-23
 moving table 6-1
 releasing space 6-28
 when FORCE_DDL_EXEC is enabled 9-26

ALTER INDEX statement 6-26, 6-27, 7-9
 TO CLUSTER clause 6-26

ALTER TABLE statement
 adding or dropping a column 6-27
 changing data type 6-27
 changing extent sizes 6-20, 6-22
 changing lock mode 8-4
 changing sbspace characteristics 6-19
 columns part of an index 6-38
 fast alter algorithm 6-39

ALTER TABLE statement (*continued*)
 in-place 6-27, 6-33, 6-34, 10-26
 sbspace fragmentation 9-6
 slow alter algorithm 6-33
 smart large objects 9-6

Alters
 in-place 6-34, 6-39
 slow 6-33

ANSI
 Repeatable Read isolation level 8-7
 Serializable isolation level 8-7

ANSI-compliant database
 access-method name 7-18

Application developer
 general responsibility 1-14
 setting PDQ priority 12-9
 SQLWARN array 5-29

Assigning table to a dbspace 6-1

Association records 11-14

Attached indexes
 creating 9-10
 defined 9-10
 extent size 7-3
 fragmentation 9-10
 physical characteristics 9-10

Auditing
 facility 1-4
 performance, and 5-45

AUDITPATH configuration parameter 5-45

AUDITSIZE configuration parameter 5-45

AUS
 expiration policies 13-8
 expiration policies, changing 13-9
 viewing UPDATE STATISTICS statements 13-10

aus_cmd_comp 13-7

aus_cmd_info 13-7

aus_cmd_list 13-7

Auto Update Statistics Evaluation 13-7

Auto Update Statistics Refresh 13-7

AUTO_AIOVPS configuration parameter 3-8, 3-19, 5-31

AUTO_CKPTS configuration parameter 5-31

AUTO_REPREPARE configuration parameter 11-12

Automated UPDATE STATISTICS 13-6
 disabling 13-11
 expiration policies 13-8
 expiration policies, changing 13-9
 ph_task table 13-10, 13-11
 rescheduling 13-10
 sequence of events 13-7
 viewing generated statements 13-10

B

B-tree
 defined 7-1
 estimating index pages 7-3, 7-4
 generic 7-18, 13-37
 index usage 7-16

B-tree scanner
 alice mode 13-21, 13-24
 compression level 13-26

- B-tree scanner (*continued*)
 - configuring to improve transaction processing 13-21
 - index compression level 13-27
 - leaf mode 13-26
 - leaf scan mode 13-21
 - range mode 13-26
 - scan modes 13-21, 13-24, 13-26
- Background I/O activities 5-29
- Backup and restore
 - fragmentation strategy for 9-4
- Backups
 - and restore
 - table placement 6-4, 9-6
- BAR_MAX_BACKUP configuration parameter 5-42
- BAR_NB_XPORT_COUNT configuration parameter 5-42
- BAR_PROGRESS_FREQ configuration parameter 5-42
- BAR_XFER_BUF_SIZE configuration parameter 5-42
- Benchmarks, for throughput 1-4
- BLOB data type
 - defined 5-6
- Blobpage
 - estimating number in tblspace 6-8
 - fullness explained 5-18
 - fullness, determining 5-17
 - fullness, interpreting average 5-18
 - logical log size 5-37
 - oncheck -pB display 5-17
 - oncheck utility
 - blobpage information 5-17
 - size 5-15
 - size and storage efficiency 5-16
 - sizing in blobspace 5-15
 - storage statistics 5-17
 - when to store in blobspace 6-8
- Blobspaces
 - advantages over dbspace 5-15
 - configuration effects 5-15
 - determining fullness 5-16
 - Parallel
 - access to table and simple large objects 5-15
 - simple large objects 6-8
 - Simple large objects
 - parallel access 5-15
 - specifying in CREATE TABLE 5-15
 - storage statistics 5-17
 - when to use 6-8
- Branch index pages 7-1
- btree_ops operator class 7-23, 7-24
- BTSCANNER configuration parameter 13-27
- Buffer pools
 - 64-bit addressing 4-13, 4-19
 - BUFFERPOOL configuration parameter 4-10
 - bypass with light scans 5-26
 - bypass with lightweight I/O 5-22
 - for non-default page sizes 4-10
 - LRU queues 5-41
 - network 3-16, 3-17
 - read cache rate 4-13
 - size, smart large objects 5-20
 - smart large objects 4-13, 5-20, 5-22
- Buffered
 - logging 5-7
- BUFFERPOOL configuration parameter 4-2, 4-10, 5-20, 5-31, 5-41, 5-46
- Buffers
 - data replication 4-44
 - free network 3-17

- Buffers (*continued*)
 - lightweight I/O 5-22, 5-23
 - logical log 4-16, 5-20
 - network 3-17
 - network, monitoring 3-17
 - physical log 4-17
 - smart large objects 5-23
 - TCP/IP connections 3-16
- Built-in data types
 - B-tree index 7-1
 - B-tree index, generic 7-18
 - functional index 7-1
- BYTE data type
 - blobspace 5-15
 - estimating table size 6-5
 - locating 6-8
 - memory cache 5-24
 - on disk 6-8
 - parallel access 5-19
 - staging area 5-24
 - storing 6-8
- Byte-range locking
 - byte lock 8-10
 - defined 8-16
 - monitoring 8-18
 - setting 8-17

C

- Cache
 - aggregate 10-32
 - data dictionary 4-23, 4-24, 4-26
 - data distribution 4-23, 4-25, 4-27
 - defined 4-23
 - opclass 10-32
 - SQL statements 4-29
 - typename 10-32
 - UDRs 4-43, 10-32
- Caches
 - private memory 3-22
- Cardinality
 - changes, and UPDATE STATISTICS 13-12
- Case studies, extended A-1, A-3
- Central processing unit
 - configuration parameters that affect 3-4
 - connections and 3-24, 3-25
 - environment variables that affect 3-4
 - utilization and 1-9
 - VPs and 3-19
- CHAR data type
 - converting to VARCHAR 6-40
 - GLS recommendations 10-28
 - key-only scans 10-1
- Checking indexes 7-15
- Checkpoints
 - automatic 5-31
 - Checkpoints
 - when occur 5-31
 - configuration parameters affecting 5-30
 - defined 5-31
 - flushing of regular buffers 5-46
 - logging and performance 5-35
 - monitoring 5-31
 - physical log, effect on 5-33
 - specifying interval 5-31
 - when occur 5-29

- Chunks
 - critical data 5-5, 6-25
 - dbspace configuration, and 5-1
 - disk partitions, and 5-2
- CKPTINTVL configuration parameter 5-31
- Class name, virtual processors 3-5
- CLEANERS configuration parameter 5-41
- CLOB data type 5-6
- Clustered index 6-26, 7-12
- Clustering
 - configuration parameters that affect it 7-10
 - defined 7-9
 - index for sequential access 10-25
- Collection-derived table
 - defined 10-15
 - folded into parent query 10-16
 - improving performance 10-16
 - query plan for 10-15
- Collections
 - scan 10-15
- Columns
 - filter expression, with join 10-5
 - filtered 7-8
 - with duplicate keys 7-9
- Commands
 - UNIX
 - cron 4-7
 - iostat 2-2
 - ps 2-2
 - sar 2-2, 4-13
 - time 1-6
 - vmstat 2-2, 4-13
- COMMIT WORK statement 1-4
- Committed Read isolation level 5-26, 8-6
- Complex query, example of 10-11
- compliance with standards xvii
- Composite index 13-19
 - order of columns 13-19
 - use of 13-19
- Compressing
 - fragments 6-44
 - tables 6-44
- Compression
 - benefits 6-44
- Concurrency
 - defined 8-1
 - effects of isolation level 8-5
 - fragmentation 9-2
 - isolation level, effects of 8-5, 10-2
 - locks, page 8-12
 - locks, row and key 8-1
 - locks, table 8-3, 8-12
 - page lock on index 8-2
- Concurrent I/O
 - confirming use of 5-4
 - enabling 5-4
 - overview 5-2, 5-4
- Configuration
 - evaluating 2-1
- Configuration parameters
 - ADTERR 5-45
 - ADTMODE 5-45
 - affecting
 - auditing 5-45
 - backup and restore 5-42
 - checkpoints 5-30
 - connections 3-17
- Configuration parameters (continued)
 - affecting (continued)
 - CPU 3-4
 - critical data 5-8
 - data dictionary 4-24, 4-26
 - data distributions 4-26
 - ipcshm connection 3-14, 4-6
 - logging I/O 5-35
 - logical log 5-8
 - memory 4-8
 - network free buffer 3-17
 - ON-Bar utility 5-42
 - page cleaning 5-40
 - physical log 5-8
 - poll threads 3-1, 3-13, 3-19
 - recovery 5-43
 - rollback 5-43
 - root dbspace 5-8
 - sequential I/O 5-28
 - SQL statement cache 4-35, 13-41
 - SQL statement cache cleaning 4-35
 - SQL statement cache hits 4-23, 4-30, 4-32, 4-33, 4-37, 4-38, 4-40
 - SQL statement cache memory 4-23, 4-30
 - SQL statement cache pools 4-38
 - SQL statement cache size 4-23, 4-37
 - SQL statement memory limit 4-37
 - UDR cache buckets 10-32, 10-33
 - UDR cache entries 10-32, 10-33
 - AUDITPATH 5-45
 - AUDITSIZE 5-45
 - AUTO_AIOVPS 3-8, 3-19, 5-31
 - AUTO_CKPTS 5-31
 - AUTO_REPREPARE 11-12
 - BAR_MAX_BACKUP 5-42
 - BAR_NB_XPORT_COUNT 5-42
 - BAR_PROGRESS_FREQ 5-42
 - BAR_XFER_BUF_SIZE 5-42
 - BTSCANNER 13-27
 - BUFFERPOOL 4-2, 4-10, 5-20, 5-31, 5-46
 - CKPTINTVL 5-31
 - CLEANERS 5-41
 - controlling PDQ resources 12-6
 - CPU, and 3-1
 - DATASKIP 5-29
 - DBSPACETEMP 5-8, 5-11, 5-12, 6-4, 7-13
 - DD_HASHMAX 4-24
 - DD_HASHSIZE 4-24
 - DEADLOCK_TIMEOUT 8-15
 - DEF_TABLE_LOCKMODE 8-4
 - DIRECT_IO 5-3, 5-4
 - DIRECTIVES 11-11, 11-12
 - DRAUTO 5-45
 - DRINTERVAL 5-45
 - DRLOSTFOUND 5-45
 - DRTIMEOUT 5-45
 - DS_HASHSIZE 4-26
 - DS_MAX_QUERIES 3-12
 - DS_MAX_SCANS 3-12, 12-6, 12-11
 - DS_POOLSIZ 4-26
 - DS_TOTAL_MEMORY 4-14, 7-13, 12-6
 - FASTPOLL 3-16
 - FILLFACTOR 7-4
 - INFORMIXOPCACHE 5-25
 - LOCKBUFF 4-2
 - LOCKS 4-2, 4-17, 8-12
 - LOGBUFF 4-16, 5-8, 5-20, 5-35

Configuration parameters *(continued)*

- LOGFILES 5-32
- LOGSIZE 5-32, 5-36, 5-37
- LOW_MEMORY_RESERVE 4-17, 5-44
- LTAPEBLK 5-43
- LTAPEDEV 5-43
- LTAPE SIZE 5-43
- LTXEHWM 5-39
- LTXHWM 5-39
- MAX_FILL_DATA_PAGES 6-43
- MAX_PDQPRIORITY 3-4, 3-11, 12-8, 12-11, 12-13, 13-32
- MIRROR 5-8
- MIRROROFFSET 5-8
- MIRRORPATH 5-8
- MULTIPROCESSOR 3-9
- NETTYPE 3-1, 3-14, 3-17, 3-19, 4-6
- OFF_RECVRY_THREADS 5-43
- ON_RECVRY_THREADS 5-43
- ONDBSPACEDOWN 5-34
- ONLIDX_MAXMEM 7-13
- OPCACHEMAX 5-25
- OPT_GOAL 13-34
- OPTCOMPIND 3-4, 3-10, 11-11, 12-12
- PC_HASHSIZE 10-32, 10-33
- PC_POOLSIZE 10-32, 10-33
- PHYSBUFF 4-2, 4-17, 5-35
- PHYSFILE 5-33
- PLOG_OVERFLOW_PATH 5-44
- RA_PAGES 5-28
- RA_THRESHOLD 5-28
- RESIDENT 4-19
- ROOTNAME 5-8
- ROOTOFFSET 5-8
- ROOTPATH 5-8
- ROOTSIZE 5-8
- RTO_SERVER_RESTART 5-30, 5-31, 5-41, 5-44
- SBS PACENAME 5-13, 5-20
- SBS PACETEMP 5-13, 5-14
- SHMADD 4-2
- SHMBASE 4-8
- SHMMAX 4-19, 4-21
- SHMTOTAL 3-23, 4-2, 4-20
- SHMVIRT_ALLOCSEG 4-21
- SHMVIRT_SIZE 4-2, 4-4, 4-21
- SINGLE_CPU_VP 3-10
- STACKSIZE 4-22
- STAGEBLOB 5-25
- STMT_CACHE 13-41
- STMT_CACHE_HITS 4-23, 4-30, 4-32, 4-33, 4-34, 4-37, 4-38, 4-40
- STMT_CACHE_NOLIMIT 4-23, 4-30
- STMT_CACHE_NUMPOOL 4-38
- STMT_CACHE_SIZE 4-23, 4-35, 4-37
- TAPEBLK 5-43
- TAPEDEV 5-43
- TAPESIZE 5-43
- TBLTBLFIRST 6-10
- TBLTBLNEXT 6-10
- USELASTCOMMITTED 8-6
- VP_MEMORY_CACHE_KB 3-22, 3-23
- VPCLASS 3-5, 3-6, 3-7, 3-8

CONNECT statement 5-2

Connections

- CPU 3-24, 3-25
 - improving performance with MaxConnect 3-25
 - multiplexed 3-24
 - specifying number of 3-14

Connections *(continued)*

- type, ipcshm 3-1, 3-14
- type, specifying 3-13, 3-14

Contention

- cost of reading a page 10-24
- reducing with fragmentation 9-3

Contiguous

- disk space, allocation 6-23
- extents
 - advantage of performance 5-21, 6-13, 6-20, 6-25
 - space, eliminating interleaved extents 6-26

Cooked file space 5-2, 5-3

- performance using concurrent I/O 5-2, 5-4
- performance using direct I/O 5-2, 5-3

Correlated subquery

- effect of PDQ 12-5

Cost of user-defined routine 13-37, 13-38

Cost per transaction 1-7

CPU

- utilization, improving with MaxConnect 3-25
- VP class and NETTYPE 3-14
- VPs
 - configuration parameters affecting 3-5
 - effect on CPU utilization 3-19
 - limited by MAX_PDQPRIORITY 3-11
 - limited by PDQ priority 3-4
 - optimal number 3-9
 - used by PDQ 12-7
 - VPs and fragmentation goals 9-2

CREATE CLUSTER INDEX statement 7-9

CREATE CLUSTERED INDEX statement 3-4

CREATE FUNCTION statement

- selectivity and cost 13-38
- virtual-processor class 3-5

CREATE INDEX ONLINE statement 7-11, 7-12

CREATE INDEX statement

- attached index 9-10
- detached index 9-11
- FILLFACTOR clause 7-4
- generic B-tree index 7-17
- parallel build 12-3
- TO CLUSTER clause 6-26
- USING clause 7-19

CREATE PROCEDURE statement

- SPL routines, optimizing 10-29
- SQL, optimizing 10-29

CREATE TABLE statement

- blob space assignment 5-15
- creating system catalog table 5-2
- extent sizes 6-20
- fragmenting 9-10, 9-11
 - with partitions 9-10, 9-11
- PUT clause 6-19
- sbspace characteristics 6-19
- sbspace fragmentation 9-6
- simple large objects 6-8
- smart large objects 9-6
- TEMP TABLE clause 5-8, 5-13
- USING clause 7-26

CREATE TEMP TABLE statement 9-13

Critical data

- configuration parameters that affect 5-8
- defined 5-34
- introduced 5-5
- mirroring 5-6

Critical media

- mirroring 5-6

Critical media (*continued*)
 separating 5-5
Critical resource 1-7
cron
 UNIX scheduling facility 2-2, 2-3, 4-7
Cursor Stability isolation level 8-7

D

Data
 migration between fragments 9-21
 transfers per second 1-11
Data conversion 10-27
Data dictionary
 DD_HASHMAX 4-24
 DD_HASHSIZE 4-24
 parameters affecting cache for 4-26
Data distributions
 creating 10-18
 creating on filtered columns 11-3
 dropping 13-13
 effect on memory 4-2
 filter selectivity 10-19
 guidelines to create 13-13
 how optimizer uses 10-18
 join columns 13-15
 multiple columns 13-19
 parameters affect cache for 4-26
 sbspaces 13-16
 syscolumns 13-13, 13-16
 sysdistrib 13-13
 user-defined data type 13-16
 user-defined statistics 13-16, 13-39
Data replication
 buffers 4-44
 performance 5-45
Data types
 BLOB 5-6
 built-in, distinct, and opaque 7-16
 BYTE 5-15, 6-5, 6-8
 CHAR 6-40, 10-1, 10-28
 CLOB 5-6
 effect of mismatch 10-27
 NCHAR 6-40, 10-25
 NVARCHAR 6-7, 10-25
 simple large object, for 6-8
 TEXT 5-15, 6-5, 6-8, 6-40
 VARCHAR 6-7, 6-40, 10-1, 10-28
Data-collector
 buffer 14-2
 process 14-1
Data-dictionary
 cache 4-23
 advantages 4-23
 configuring 4-24
Data-dictionary cache
 configuring 4-26
 monitoring 4-24
Data-distribution cache
 defined 4-25
 monitoring 4-27
Database server administrator
 allocating DSS memory 12-10
 controlling DSS resources 3-11, 12-14
 creating staging-area blobspace 5-24
 halting database server 5-34
 limiting number of DSS queries 12-12

Database server administrator (*continued*)
 limiting PDQ priority 12-13
 marking dbspace down 5-34
 placing system catalog tables 5-2
 responsibility of 1-14, 5-1
 specifying unavailable fragments 9-3
 using MAX_PDQPRIORITY 12-13
DATABASE statement 5-2
DataBlade API functions, smart large objects 5-19, 5-21, 6-17,
 6-22, 8-19
DataBlade modules
 functional index 7-21
 new index 7-22
 secondary access method 7-16
 user-defined index 7-2, 7-16
DATASKIP configuration parameter 5-29
DB-Access utility 2-3, 6-25
dbload utility 6-25, 7-10
dbschema utility
 data distributions 9-7
 distribution output 13-17
 examining value distribution 9-4
dbspaces
 chunk configuration 5-1
 configuration parameters affecting root 5-8
 mirroring root 5-6
 page size, specifying 7-6
 reorganizing to prevent extent interleaving 6-25
 specifying page size when creating 4-10
 temporary tables and sort files 5-8, 6-4
DBSPACETEMP
 parallel inserts 12-2
DBSPACETEMP configuration parameter 5-8, 5-11, 6-4, 7-13
 overriding 5-11
DBSPACETEMP environment variable 5-8, 6-4, 7-13
 advantages over PSORT_DBTEMP 5-11
DBUPSPACE environment variable 13-19
DD_HASHMAX configuration parameter 4-24
DD_HASHSIZE configuration parameter 4-24
Deadlock 8-15
DEADLOCK_TIMEOUT configuration parameter 8-15
Decision-support queries 1-2
 balanced with transaction throughput 1-6
 controlling resources 12-14
 effects of DS_TOTAL_MEMORY 4-14
 gate information 12-15
 gate numbers 12-15
 monitoring resources allocated 12-14, 12-18, 13-50
 monitoring threads 12-17, 13-48
 performance impact 1-7
 use of temporary files 9-5
DEF_TABLE_LOCKMODE configuration parameter 8-4
Denormalizing
 data model 6-39
 tables 6-40
Detached index
 defined 9-11
 extent size 7-3
Dimensional tables, defined 13-20
Direct I/O
 confirming use of 5-4
 enabling 5-4
 overview 5-2, 5-3
DIRECT_IO configuration parameter 5-3, 5-4
DIRECTIVES configuration parameter 11-11, 11-12
Dirty Read isolation level 5-26, 8-10

- Disabilities, visual
 - reading syntax diagrams B-1
 - Disability B-1
 - Disk
 - and saturation 5-1
 - compression 6-44
 - critical data 5-5
 - layout
 - and table isolation 6-2
 - layout, and backup 6-4, 9-4
 - partitions and chunks 5-2
 - space, storing TEXT and BYTE data 5-17
 - utilization 1-11
 - Disk access
 - cost of reading row 10-24
 - performance 13-30
 - performance effect of 10-24
 - sequential 13-30
 - sequential forced by query 13-3
 - Disk extent
 - for dbspaces 6-20
 - for sbspaces 5-21
 - Disk I/O
 - allocating AIO VPs 3-8
 - background database server activities 1-1
 - balancing 5-10, 5-14
 - binding AIO VPs 3-8
 - blob space data and 5-15
 - BUFFERPOOL configuration parameter 4-10
 - contention 10-24
 - effect of UNIX configuration 3-3
 - effect of Windows configuration 3-3
 - effect on performance 5-1
 - for temporary tables and sort files 5-8
 - hot spots, definition of 5-1
 - in query plan cost 10-1, 10-9, 10-18
 - isolating critical data 5-5
 - KAIO 3-8
 - light scans 5-26
 - lightweight I/O 5-22
 - log buffer size, effect of 5-7
 - logical log 5-23
 - mirroring, effect of 5-6
 - monitoring
 - AIO VPs 3-8
 - nonsequential access, effect of 7-8
 - query response time 1-5
 - read-ahead configuration parameters 5-28
 - reducing 4-13, 6-40
 - sbspace data and 5-19
 - sequential scans 5-26
 - simple large objects 5-15
 - smart large objects 5-21, 5-22
 - to physical log 5-7
 - TPC-A benchmark 1-4
 - unbuffered devices 5-11
 - Disks
 - identifying overloaded ones A-1
 - Distinct data types 7-16
 - DISTINCT keyword 13-19
 - Distributed queries
 - improving performance 13-28
 - used with PDQ 12-5
 - Distribution scheme
 - defined 9-1
 - designing 9-6, 9-7
 - methods described 9-6
 - Dotted decimal format of syntax diagrams B-1
 - DRAUTO configuration parameter 5-45
 - DRINTERVAL configuration parameter 5-45
 - DRLOSTFOUND configuration parameter 5-45
 - DROP DISTRIBUTIONS keywords, in UPDATE STATISTICS statement 13-13
 - DROP INDEX ONLINE statement 7-11, 7-12
 - Dropping indexes 7-10
 - DRTIMEOUT configuration parameter 5-45
 - DS_HASHSIZE configuration parameter 4-26
 - DS_MAX_QUERIES configuration parameter 3-12
 - changing value 12-7
 - index build performance 7-13
 - limit query number 12-12
 - MGM 12-6
 - DS_MAX_SCANS configuration parameter 3-12, 12-6, 12-11
 - changing value 12-7
 - MGM 12-6
 - scan threads 12-6
 - DS_NONPDQ_QUERY_MEM configuration parameter 4-8, 5-11, 13-33
 - DS_POOLSIZE configuration parameter 4-26
 - DS_TOTAL_MEMORY configuration parameter 4-14, 7-13
 - changing value 12-7
 - DS_MAX_QUERIES 3-12
 - estimating value 4-14, 12-10
 - MAX_PDQPRIORITY 12-7
 - MGM 12-6
 - setting for DSS applications 12-14
 - setting for OLTP 12-10
 - DSS resources
 - limiting 12-7
 - dtcurrent() function, ESQL/C, to get current date and time 1-7
 - Duplicate index keys, performance effects of 7-9
 - Dynamic lock allocation 4-2, 4-17, 13-48
 - Dynamic log
 - file allocation
 - benefits 5-38
 - preventing hangs from rollback of long transaction 5-38
 - size of new log 5-38
- ## E
- Environment variables
 - affecting
 - CPU 3-4
 - I/O 5-11
 - multiplexed connections 3-24
 - network buffer pool 3-16, 3-17
 - network buffer size 3-16, 3-18
 - parallel sorts 5-12
 - sort files 5-11
 - sorting 5-5, 5-8
 - SQL statement cache 13-41
 - temporary tables 5-5, 5-8, 5-11
 - DBSPACETEMP 5-5, 5-8, 5-11, 6-4, 7-13
 - DBUPSPACE 13-19
 - FET_BUF_SIZE 13-29
 - IFX_AUTO_REPREPARE 11-12
 - IFX_DEF_TABLE_LOCKMODE 8-4
 - IFX_DIRECTIVES 11-11
 - IFX_LARGE_PAGES 4-2
 - IFX_SESSION_MUX 3-24
 - INFORMIXOPCACHE 5-24, 5-25
 - OPT_GOAL 13-34

Environment variables (*continued*)

- OPTCOMPIND 3-4, 3-10, 12-12
- PDQPRIORITY
 - adjusting the value 12-7
 - for UPDATE STATISTICS 13-19
 - limiting resources 3-4
 - parallel sorts 13-32
 - requesting PDQ resources 12-7
 - setting PDQ priority 7-13
- PSORT_DBTEMP 5-11
- PSORT_NPROCS 3-4, 5-12, 7-13, 13-32
- STMT_CACHE 13-41

equal() function 7-24

Equality expression, definition of 9-15

ESQL/C

- functions, for smart large objects 5-19, 5-21, 6-17, 6-22, 8-19

Estimating space

- index extent size 7-3
- sbspaces 6-10
- smart large objects 6-10

EXECUTE PROCEDURE statement 10-32

Expiration policies, AUS 13-8

- changing 13-9
- ph_threshold table 13-9

EXPLAIN_SQL routine 10-18

EXPLAIN_STAT configuration parameter 10-10

Explicit temporary table 9-13

Expression-based distribution scheme

- defined 9-6
- designing 9-7
- fragment elimination 9-15
- type to use 9-13

EXTENT SIZE clause 6-20

Extents

- allocating 6-20
- attached index 9-11
- eliminating interleaved 6-25
- index of fragmented table 9-9
- interleaved 6-25
- managing 6-20
- managing deallocation with TRUNCATE 6-28
- next-extent size 6-20
- performance 5-21, 6-20, 6-25
- reclaiming empty space 6-25, 6-27
- reorganizing dbspace to prevent interleaving 6-25
- size 6-20
- size for attached index 7-3
- size for detached index 6-25, 7-3
- size for tblspace tblspace 6-10
- size limit 6-23
- size, initial 6-10
- size, next-extent 6-10
- sizes for fragmented table 9-5
- upper limit on number 6-23

External optimizer directives 11-1, 11-14

F

Fact table

- star schema 13-20

Fast polling 3-16

Fast recovery

- configuration effects 5-43
- physical log overflow 5-44

FASTPOLL configuration parameter 3-16

FET_BUF_SIZE environment variable 13-29

File descriptors 3-2

Files

- \$INFORMIXDIR/bin 14-4
- dbspaces for sort 6-4
- executables for onperf 14-4
- saving performance metrics 14-2
- TEMP or TMP user environment variable 5-8

FILLFACTOR

- CREATE INDEX 13-28

FILLFACTOR clause

- CREATE INDEX statement 7-4

FILLFACTOR configuration parameter 7-4

Filter

- columns 10-5
- columns in large tables 7-8
- defined 10-19, 13-2
- effect on performance 13-3
- effect on sorting 10-23
- evaluated from index 13-19
- index used to evaluate 10-20
- memory used to evaluate 10-22
- query plan 11-2
- selectivity defined 10-19
- selectivity estimates 10-19
- user-defined routines 13-2

Flattened subquery 10-14

FORCE_DDL_EXEC Environment Option 9-26

Forced residency 4-19

Foreground write 5-40

Formula

- blobpage size 6-8
- buffer pool size 4-10
- connections per poll thread 3-14
- CPU utilization 1-9
- data buffer size, estimate of 4-3
- decision-support queries 12-10
- disk utilization 1-11
- DS total memory 4-15, 4-16
- extends, upper limit 6-23
- file descriptors 3-2
- for RA_PAGES values 5-28
- for RA_THRESHOLD values 5-28
- index extent size 7-3
- index pages 6-5, 7-4
- initial stack size 4-22
- LOGSIZE 5-37
- memory grant basis 12-11
- minimum DS memory 4-15
- number of remainder pages 6-5
- operating-system shared memory 4-6
- paging delay 1-10
- partial remainder pages 6-5
- PDQ resources allocated 3-11
- quantum of memory 4-14, 12-6, 12-14
- rows per page 6-5
- scan threads 12-6
 - per query 3-12, 12-11
- semaphores 3-1
- service time 1-8
- shared memory
 - message portion size 4-6
 - resident portion size 4-3, 4-4
 - virtual portion size 4-4
- shared-memory estimate 12-10
- shared-memory increment size 4-19
- sort operation, costs 10-23
- threshold for free network buffers 3-17

- Fragment
 - elimination
 - defined 9-13
 - equality expressions 9-15
 - fragmentation expressions 9-13
 - range expressions 9-14
 - ID
 - and index entry 7-4
 - defined 9-11
 - fragmented table 9-5
 - space estimates 9-5
 - nonoverlapping
 - multiple columns 9-17
 - single column 9-16
 - overlapping
 - single column 9-16
- FRAGMENT BY clause 9-9
- Fragmentation
 - altering fragments 9-26
 - FRAGMENT BY EXPRESSION clause 9-10, 9-11
 - goals 9-1
 - improving ATTACH operation 9-19, 9-23
 - improving DETACH operation 9-25, 9-26
 - index restrictions 9-12
 - indexes, attached 9-9
 - indexes, detached 9-11
 - monitoring I/O requests 9-27
 - monitoring with onstat 9-27
 - next-extent size 9-8
 - no data migration during ATTACH 9-21
 - reducing contention 9-3
 - smart large objects 9-6
 - strategy
 - ALTER FRAGMENT ATTACH clause 9-19, 9-24
 - ALTER FRAGMENT DETACH clause 9-25, 9-26
 - distribution schemes for fragment elimination 9-13
 - finer granularity of backup and restore 9-4
 - how data used 9-4
 - improved performance 9-3
 - improving 9-8
 - increased availability of data 9-3
 - indexes 9-9
 - planning 9-1
 - reduced contention 9-3
 - space issues 9-1
 - temporary tables 9-13
 - sysfragments system catalog 9-27
 - TEMP TABLE clause 9-13
 - temporary tables 9-13
- Freeing shared memory 4-7
- Functional index
 - creating 7-20, 7-21
 - DataBlade modules 7-21
 - user-defined function 7-1
 - using 7-20, 13-2
- Functions, ESQ/L/C, dtcurrent() 1-7

G

- Generic B-tree
 - index
 - extending 7-18
 - parallel UDRs 13-37
 - user-defined data 7-1
 - when to use 7-18
- Global file descriptor queues 3-21

- Graph tool (onperf)
 - bar graph 14-8
 - Configure menu 14-8
 - defined 14-3, 14-5
 - Graph menu 14-6
 - Graph tool (onperf)
 - View menu 14-8
 - metric
 - changing line color and width 14-8
 - changing scale 14-10
 - Metrics menu 14-7
 - pie chart 14-8
 - Tools menu 14-9
- greaterthan() function 7-24
- greaterthanorequal() function 7-24
- GROUP BY
 - clause, composite index used 13-19
 - clause, indexes 10-20, 13-31
 - clause, MGM memory 12-6

H

- Hash join
 - in directives 11-2, 11-5
 - more memory for 5-11, 13-33
 - plan example 10-2
 - temporary space 5-11
 - when used 10-3
- High-Performance Loader 6-1
- Home pages in indexes 6-5
- Host variable
 - SQL statement cache 13-40
- Hot spots, defined 5-1

I

- I/O utilization
 - options for monitoring 2-10
- IBM Data Studio 10-18
- IBM Informix MaxConnect
 - defined 3-25
- IBM Informix Server Administrator
 - capabilities 2-5
 - defined 2-5
 - generating UPDATE STATISTICS statements 13-11
 - monitoring I/O Utilization 2-10
 - monitoring latches 4-45
 - monitoring SQL statement cache 4-32
 - monitoring user sessions 2-13, 13-53
 - monitoring virtual processors 3-22
 - starting virtual processors 3-19
- Identifying overloaded disks A-1
- IFX_AUTO_REPREPARE session environment variable 11-12
- IFX_DEF_TABLE_LOCKMODE environment variable 8-4
- IFX_DIRECTIVES environment variable 11-11
- IFX_EXTDIRECTIVES environment variable 11-14
- IFX_LARGE_PAGES environment variable 4-2
- IFX_NETBUF_PVTPOOL_SIZE environment variable 3-16, 3-17
- IFX_NETBUF_SIZE environment variable 3-16, 3-18
- IFX_SESSION_MUX environment variable 3-24
- In-place alter algorithm
 - Alters
 - in-place 6-33
 - performance advantages 6-33
 - when used 6-34

Index

- adding for performance 7-8
- and previously prepared statement problem 11-12
- attached index extent size 7-3
- autoindex
 - for inner table 10-2
 - replacing with permanent 13-19
- checking 7-15
- choosing columns 7-8
- composite 13-19
- cost of on NCHAR 10-25
- cost of on NVARCHAR 10-25
- cost of on VARCHAR 10-1
- creating in online environment 7-11, 7-12
- DataBlade modules 7-22
- detached index extent size 7-3
- disk space used by 7-6, 13-30
- distinct types 7-16
- dropping 6-32, 7-10
- dropping in online environment 7-11, 7-12
- duplicate entries 7-9
- duplicate keys, avoiding 7-9
- effect of physical order of table rows 10-6
- estimating pages 7-4
- estimating space 7-3, 7-4
- extent size 7-3
- filtered columns 7-8
- functional 7-20, 13-2
- impact on delete, insert, and update operations 7-7
- key-only scan 10-1
- managing 7-6
- on CHAR column 10-1
- on fact table in star schema 13-20
- opaque data types 7-16
- order-by and group-by columns 7-8
- ordering columns in composite 13-19
- placement on disk 7-3
- size estimate 7-4
- snowflake or star schemas 13-20
- structure of entries 7-1
- time cost 7-7
- User-defined data types 7-16, 7-26
- when not used by optimizer 10-28, 13-3
- when replaced by join plans 10-6
- when to rebuild 13-28

Index self-join 10-7

Index self-join path 10-7

Indexes

- clustered 6-26, 7-12
- improving performance 13-19

industry standards xvii

INFORMIXOPCACHE environment variable 5-24, 5-25

Inner table

- directives 11-6
- index 10-2

Input-output (I/O)

- background activities 5-29
- contention and high-use tables 6-2
- disk saturation 5-1
- tables, configuring 5-26

INSERT cursor 9-6

INTO TEMP clause of the SELECT statement 5-8, 5-10, 5-14, 6-25

iostat command 2-2

ipcshm

- connection 3-14

ipcshm connection 4-6

Isolating tables 6-2

Isolation level

- ANSI Repeatable Read 8-7
- ANSI Serializable 8-7
- Committed Read 5-26, 8-6
- Cursor Stability 8-7
- Dirty Read 5-26, 8-5, 8-10
- effect on concurrency 10-2
- effect on joins 10-2
- Last Committed 8-6
- light scans 5-26
- monitoring 2-5, 2-13, 8-15
- Repeatable Read 5-26, 8-7
- Repeatable Read and OPTCOMPIND 10-21, 12-12
- SET ISOLATION statement 8-5

J

Join

- avoiding 13-3
- column for composite index 13-19
- directives 11-5
- effect of large join on optimization 13-36
- hash join 10-2
- hash join, when used 10-3
- methods 10-2, 10-21
- nested-loop join 10-2
- order 10-3, 11-2, 11-3, 11-7
- outer 12-9
- parallel execution 12-9
- plan 11-3
 - defined 10-2
 - directive precedence 11-11
 - directives 11-6
 - effects of OPTCOMPIND 10-21
 - hash 11-7, 12-12, 12-19
 - hash, in directives 11-2, 11-5
 - isolation level effect 10-2
 - nested-loop 11-5, 11-7
 - OPTCOMPIND 12-12
 - optimizer choosing 11-2
 - replacing index use 10-3
 - selected by optimizer 10-1
 - star 13-20
 - subquery 10-14
- running UPDATE STATISTICS on columns 13-15
- semi join 10-14
- SET EXPLAIN output 12-12
- subquery 12-9
- subquery flattening 10-14
- thread 12-1
- three-way 10-3
- view 12-9
 - with column filters 10-5

Join and sort, reducing impact 13-31

K

- Kernel asynchronous I/O (KAIO) 3-8
- Key-first scan 10-13
- Key-only index scan 10-1, 10-13, 10-35

L

Last committed isolation level 8-6

- Latch
 - defined 4-44
 - monitoring 4-44, 4-45
- Latency, disk I/O 10-24
- Leaf index pages, defined 7-1
- Leaf scan mode 13-21, 13-26
- Least recently used
 - flushing 5-46
 - memory management algorithm 1-10
 - queues 5-41
 - thresholds for I/O to physical log 5-7
- lessthan() function 7-24
- lessthanorequal() function 7-24
- Light scans
 - advantages 5-26
 - defined 5-26
 - isolation level 5-26
 - mentioned 4-9
 - when occur 5-26
- Lightweight I/O
 - specifying in onspaces 5-23
 - specifying with LO_NOBUFFER flag 5-23
 - when to use 4-13, 5-22, 5-23
- LIKE test 13-3
- LO_DIRTY_READ flag 8-19
- LO_NOBUFFER flag, specifying lightweight I/O 5-23
- LO_TEMP flag
 - temporary smart large object 5-13
- LOAD and UNLOAD statements 6-1, 6-25, 6-28, 7-10
- Locating simple large objects 6-8
- Lock
 - blobpage 5-15
 - determining owner 8-13
 - dynamic allocation 4-2, 4-17
 - isolation levels and join 10-2
 - promotable 8-9
 - retaining update locks 8-9
 - specifying mode 8-4
- Lock table
 - specifying initial size 4-2, 4-17
- LOCKBUFF configuration parameter 4-2
- Locking
 - byte-range 8-16
- Locks
 - byte 8-10
 - byte-range 8-16
 - changing lock mode 8-4
 - concurrency 8-1
 - configuring 8-12
 - database 8-3
 - defined 8-1
 - duration 8-5
 - exclusive 8-10
 - granularity 8-1
 - initial number 8-12
 - intent 8-10
 - internal lock table 8-10
 - isolation level 8-5
 - key-value 8-2
 - maximum number of 4-17, 8-12
 - maximum number of rows or pages 8-1
 - monitoring 8-11, 8-12, 8-14, 8-18
 - not waiting for 8-5
 - page 8-2
 - row and key 8-1
 - shared 8-10
 - specifying a mode 8-4
- Locks (*continued*)
 - table 8-3
 - types 8-10
 - update 8-10
 - waiting for 8-5
- LOCKS configuration parameter 4-2, 4-17, 8-12
- LOGBUFF configuration parameter 4-16, 5-8, 5-20, 5-35
- LOGFILES configuration parameter
 - effect on checkpoints 5-32
 - use in logical-log size determination 5-35
- Logging
 - checkpoints 5-35
 - configuration effects 5-35
 - dbspaces 5-37
 - disabling on temporary tables 5-40
 - I/O activity 5-20
 - LOGSIZE configuration parameter 5-36, 5-37
 - none with SBSPACETEMP configuration parameter 5-13
 - simple large objects 5-15, 5-37
 - smart large objects 5-38
 - with SBSPACENAME configuration parameter 5-13
- Logical log
 - assigning files to a dbspace 5-5
 - buffer size 4-16
 - buffered 5-7
 - configuration parameters that affect 5-8
 - data replication buffers 4-44
 - determining disk space allocated 5-35
 - logging mode 5-7
 - mirroring 5-7
 - simple large objects 5-37
 - size guidelines 5-36
 - smart large objects 5-38
 - space 5-36
 - unbuffered 5-7
 - viewing records 1-4
- LOGSSIZE configuration parameter 5-32
- Long transaction
 - ALTER TABLE operation 6-33
 - configuration effects 5-38, 5-39
 - dynamic log effects 5-39
 - LTXHWM configuration parameter 6-33
 - preventing hangs from rollback 5-38
- Loosely-coupled mode 13-53
- LOW_MEMORY_RESERVE configuration parameter 4-17, 5-44
- LRU tuning 5-46
 - lru_max_dirty value 5-31, 5-41, 5-46
 - lru_min_dirty value 5-31, 5-41, 5-46
- LRU. 1-10
- lrus value 5-41
- LTAPEBLK configuration parameter 5-43
- LTAPEDEV configuration parameter 5-43
- LTAPESIZE configuration parameter 5-43
- LTXEHWM configuration parameter 5-39
- LTXHWM configuration parameter 5-39

M

- Managing extents 6-20
- Materialized view
 - defined 10-26
 - involving table hierarchy 10-35
- MAX_FILL_DATA_PAGES configuration parameter 6-43
- MAX_PDQPRIORITY configuration parameter 3-11
 - and PDQPRIORITY 3-4
 - changing value 12-7

- MAX_PDQPRIORITY configuration parameter *(continued)*
 - for DSS query limits 12-7, 12-8
 - increasing OLTP resources 12-8
 - limiting concurrent scans 12-11
 - limiting PDQ resources 5-12, 13-32
 - limiting user-requested resources 12-13
 - MGM 12-6
 - PDQPRIORITY, and 12-9, 12-13
- Memory
 - activity costs 10-22
 - cache 4-23
 - aggregate 10-32
 - data-dictionary 4-23, 4-24
 - configuration parameters 4-8
 - data-replication buffers 4-44
 - estimate for sorting 7-14
 - hash join 5-11
 - hash joins 13-33
 - increase by logging 5-23
 - limited by
 - MAX_PDQPRIORITY 3-11
 - PDQ priority 3-4
 - STMT_CACHE_NOLIMIT 4-30
 - monitoring by session 12-18
 - monitoring MGM allocation 12-6
 - network buffer pool 3-16, 3-17, 3-18
 - opclass cache 10-32
 - PDQ priority effect 7-14, 12-7
 - private caches 3-22
 - private network free-buffer pool 3-16, 3-17
 - quantum allocated by MGM 12-6, 12-14, 12-15
 - SPL routines 12-10
 - SQL statement cache 13-39
 - typename 10-32
 - UDR cache 10-32
 - UNIX configuration parameters 3-3
 - utilizing 1-10
 - Windows parameters 3-3
- Memory Grant Manager
 - defined 12-6
 - DSS queries 12-6
 - memory allocated 4-14
 - monitoring resources 12-6, 12-14
 - scan threads 12-6
 - sort memory 7-14
- Memory-management system 1-10
- Messages
 - portion of shared memory 4-3, 4-6
- Metadata
 - area in sbspace
 - contents 6-10
 - estimating size 6-11, 6-12
 - logging 5-38
 - mirroring 5-6
 - reserved space 6-11
 - improving I/O for smart large objects 6-12
- Metric classes, onperf
 - database server 14-13
 - disk chunk 14-15
 - disk spindle 14-15
 - fragment 14-18
 - physical processor 14-15
 - session 14-16
 - tblspace 14-17
 - virtual processor 14-16
- Microsoft Transaction Server
 - tightly coupled mode 13-53
- MIRROR configuration parameter 5-8
- Mirroring
 - critical media 5-6
 - root dbspace 5-6, 5-8
 - sbspaces 5-6
- MIRROROFFSET configuration parameter 5-8
- MIRRORPATH configuration parameter 5-8
- MODIFY EXTENT SIZE keyword
 - in ALTER TABLE statement 6-20
- MODIFY NEXT SIZE clause 6-20, 6-22
- mon_table_profile 13-7
- Monitoring
 - aggregate cache 10-33
 - AIO virtual processors 3-21
 - buffer pool 4-13
 - buffers 4-13
 - data-dictionary cache 4-24
 - data-distribution cache 4-27
 - deadlocks 8-15
 - disk utilization 2-10
 - foreground writes 5-40
 - fragments 9-27
 - global transactions 13-53, 13-55
 - I/O queues for AIO VPs 3-8
 - isolation level 2-13
 - latch waits 4-44, 4-45
 - light scans 5-26
 - locks 2-13, 8-11, 8-12, 8-13, 8-14, 13-53, 13-55
 - locks used by sessions 8-12
 - logical-log files 2-12
 - LRU queues 5-41
 - memory per thread 4-4
 - memory usage 4-4
 - memory utilization 2-8
 - MGM resources 12-14
 - network buffer size 3-18
 - network buffers 3-17
 - OPCACHEMAX 5-24
 - PDQ threads 12-17
 - resources for a session 12-18
 - sbspace metadata size 6-11, 6-12
 - sbspaces 6-13, 6-16
 - session memory 2-14, 4-4, 4-43, 13-42, 13-43, 13-44, 13-45, 13-47, 13-50
 - sessions 13-47, 13-50
 - smart large objects 6-13
 - SPL routine cache 10-33
 - SQL statement cache 4-32, 4-34, 4-40, 13-45
 - entries 13-45
 - pool 4-38, 4-39
 - size 4-35, 4-36, 4-39
 - SSC memory pools 4-32
 - STAGEBLOB blobspace 5-24
 - statement cache 4-33
 - statement memory 2-14, 13-42, 13-45
 - threads 13-47, 13-48, 13-49
 - concurrent users 4-4
 - per CPU VP 3-9
 - session 3-9, 12-17
 - throughput 1-4
 - transaction 2-13, 13-53
 - transactions 2-13
 - UDR cache 10-33
 - user sessions 2-13, 13-55
 - user threads 2-13, 13-53
 - virtual portion 4-5
 - virtual processors 3-20, 3-21, 3-22

- Monitoring database server
 - active tablespaces 6-23
 - blob space storage 5-17
 - buffers 4-13
 - sessions 2-14, 13-46
 - threads 2-7, 13-46
 - transactions 13-53
 - virtual processors 3-19
- Monitoring tools
 - database server utilities 2-3
 - UNIX 2-2
 - Windows 2-2
- Motif window manager 14-1, 14-3, 14-4
- Multiple residency
 - avoiding 3-1
- Multiplexed connection
 - defined 3-24
 - how to use 3-24
 - performance improvement 3-24
- MULTIPROCESSOR configuration parameter 3-9
- mwm window manager, required for onperf 14-4

N

- NCHAR data type 6-40
- Negator functions 13-39
- Nested-loop join 10-2, 11-5
- NET VP class and NETTYPE 3-14
- NETTYPE configuration parameter 4-4
 - connections 3-17
 - estimating LOGSIZE 5-37
 - ipcshm connection 3-14, 4-6
 - network free buffer 3-17
 - poll threads 3-1, 3-19
 - specifying connections 3-13, 3-14
- Network
 - buffer pools 3-16, 3-17
 - buffer size 3-18
 - common buffer pool 3-16, 3-18
 - communication delays 5-1
 - connections 3-13
 - free-buffer threshold 3-17
 - monitoring buffers 3-17
 - multiplexed connections 3-24
 - performance bottleneck 2-1
 - performance issues 10-28
 - private free-buffer pool 3-16, 3-17
- NEXT SIZE clause 6-20
- NFILE configuration parameters 3-2
- NFILES configuration parameters 3-2
- NOFILE configuration parameters 3-2
- NOFILES configuration parameters 3-2
- NVARCHAR data type 6-7
 - table-size estimates 6-7

O

- Obtaining 4-10, 6-5
- OFF_RECVRY_THREADS configuration parameter 5-43
- OLTP applications
 - effects of MAX_PDQPRIORITY 3-11
 - effects of PDQ 12-7
 - maximizing throughput with MAX_PDQPRIORITY 12-7, 12-8, 12-9
 - reducing DS_TOTAL_MEMORY 12-10
 - using MGM to limit DSS resources 12-6

- OLTP query 1-2
- ON_RECVRY_THREADS configuration parameter 5-43
- ON-Bar utility
 - configuration parameters 5-42
- ON-Monitor utility 3-19
- onaudit utility 5-45
- oncheck utility
 - pB option 2-11, 5-17
 - pe option 2-11, 6-14, 6-25, 6-26
 - pk option 2-11
 - pK option 2-11
 - pl option 2-11
 - pL option 2-11
 - pp option 2-11
 - pP option 2-11
 - pr option 2-11, 6-37
 - ps option 2-11
 - pS option 2-11, 6-15
 - pt option 2-11, 6-5
 - pT option 2-11, 6-37
- checking index pages 7-15
- defined 2-11
- displaying
 - data-page versions 6-37
 - free space 6-26
 - free space in index 13-28
 - page size 6-37
 - size of table 6-5
- index sizing 7-4
- monitoring
 - table growth 6-22
- obtaining information
 - blob spaces 5-17, 5-19
 - sbspaces 6-14
- outstanding in-place alters 6-37
- physical layout of chunk 6-25
- ONDBSPACEDOWN configuration parameter 5-34
- ONLIDX_MAXMEM configuration parameter 7-11, 7-13
- onload and onunload utilities 5-43, 6-1, 6-25, 6-28
- onlog utility 1-4, 2-12
- onmode utility
 - e option 13-40, 13-41
 - p option 3-19
 - P option 3-8
 - W option 4-34
 - changing STMT_CACHE_NOLIMIT 4-37
 - F option 4-7
- flushing SQL statement cache 13-40
- forced residency 4-19
- PDQ 12-15
- shared-memory connections 3-1
- onparams utility 5-5, 5-7
- onperf utility
 - activity tools 14-12
 - data flow 14-1
 - defined 14-1
 - displaying recent history 14-10
 - graph tool 14-5
 - metric classes
 - database server 14-13
 - disk chunk 14-15
 - disk spindle 14-15
 - fragment 14-18
 - physical processor 14-15
 - session 14-16
 - tblspace 14-17
 - virtual processor 14-16

- onperf utility (*continued*)
 - metrics 14-13
 - monitoring tool 2-3
 - query-tree tool 14-11
 - replaying metrics 14-3
 - requirements 14-3
 - saving metrics 14-2
 - starting 14-4
 - status tool 14-11
 - tools 14-3
 - user interface 14-5
- onspaces utility
 - Df BUFFERING tag 5-23
 - Df option 5-21, 6-19
 - S option 6-19
 - t option 5-10, 5-14, 6-4, 7-13
 - EXTENT_SIZE flag for sbspaces 5-21
 - sbspaces 5-19, 5-23
 - smart large objects 6-17
 - specifying lightweight I/O 5-23
- onstat utility
 - option 2-6
 - a option 2-6
 - b option 2-6, 4-3, 4-10, 6-5, 6-8
 - d option 3-21, 6-11, 6-12
 - F option 2-6, 5-40
 - g act option 13-47, 13-49
 - g afr option 3-18
 - g ath option 3-9, 12-17, 13-47, 13-48, 13-49
 - g cac option 10-33
 - g cac stmt option 4-33
 - g cpu option 13-47
 - g dic option 4-24, 4-27
 - g dsc option 4-27
 - g glo option 3-20, 3-24
 - g iof option 2-10
 - g iog option 2-10
 - g ioq option 2-10, 3-8, 3-21
 - g iov option 2-10
 - g mem option 2-8, 13-47, 13-50
 - g mgm option 2-8, 12-6, 12-14
 - g ntm option 3-17
 - g ntu option 3-17
 - g opn option 6-29
 - g option 2-6
 - g osi option 2-8
 - g ppf option 9-27
 - g prc option 10-33
 - g rea option 3-20
 - g scn to monitor light scans 5-26
 - g seg option 2-8, 4-5, 4-19
 - g ses option 2-8, 2-14, 3-9, 4-4, 12-18, 13-42, 13-43, 13-44, 13-45, 13-47, 13-50
 - g smb option 6-13
 - g smb s option 6-16
 - g spi option 4-32, 4-38
 - g sql option 2-14, 13-44, 13-45
 - g sql session-id option 2-13, 13-53
 - g ssc 4-32
 - g ssc all 4-32
 - g ssc all option 4-34
 - g ssc option 4-33, 4-34, 4-35, 4-39, 4-40, 13-45
 - g ssc output description 4-40
 - g ssc pool option 4-39
 - g stm option 2-8, 2-14, 4-4, 4-43, 13-42, 13-45, 13-47, 13-50
 - g sts option 4-4
 - k option 2-13, 8-11, 8-13, 8-19, 13-53, 13-55
- onstat utility (*continued*)
 - l option 2-6
 - L option 8-14
 - m option 5-31
 - O option 5-24
 - p option 1-4, 2-6, 4-13, 4-44, 8-12, 8-15
 - R option 2-6
 - s option 4-45
 - t option 6-23
 - u option 2-6, 2-13, 4-4, 8-12, 8-13, 12-17, 13-47, 13-53, 13-55
 - x option 2-6, 13-53
- monitoring
 - AIO virtual processors 3-21
 - buffer use 4-13
 - byte locks 8-10
 - locks 13-55
 - PDQ 12-14
 - sessions 13-47
 - SQL statement cache 4-32
 - tblspaces 6-23
 - transactions 13-53
 - user sessions 13-55
 - virtual processors 3-20, 3-24
 - options for monitoring disk I/O utilization 2-10
 - options for monitoring threads 2-7
 - options for monitoring transactions 2-13
 - overview for performance monitoring 2-6
- ontape utility 5-43
- Opaque data types 7-16
- OPCACHEMAX configuration parameter
 - defined 5-25
- OpenAdmin Tool 2-4
- Operating system
 - configuration parameters 3-1
 - file descriptors 3-2
 - NOFILE, NOFILES, NFILE, or NFILES configuration parameters 3-2
 - semaphores 3-1
 - SHMMAX configuration parameter 4-6
 - SHMMNI configuration parameter 4-6
 - SHMSEG configuration parameter 4-6
 - SHMSIZE configuration parameter 4-6
 - timing commands 1-6
- Operator class
 - defined 7-18, 7-22
- OPT_GOAL configuration parameter 13-34
- OPT_GOAL environment variable 13-34
- OPTCOMPIND
 - directives 11-11
 - effects on query plan 10-21
 - preferred join plan 12-12
- OPTCOMPIND configuration parameter 3-4, 3-10, 12-12
- OPTCOMPIND environment variable 3-4, 3-10, 12-12
- Optical Subsystem 5-24
- Optimization goal
 - default total query time 13-34
 - precedence of settings 13-35
 - setting with directives 11-7, 13-35
 - total query time 13-34, 13-36
 - user-response and fragmented indexes 13-36
 - user-response time 13-34, 13-36
- Optimization level
 - default 13-34
 - setting to low 13-34
 - table scan versus index scan 13-36

- Optimizer
 - autoindex path 13-19
 - choosing query plan 11-2, 11-3
 - composite index use 13-19
 - data distributions used by 13-13
 - hash join 10-3
 - index not used by 13-3
 - optimization goal 11-7, 13-34
 - SET OPTIMIZATION statement 13-34
 - specifying high or low level of optimization 13-34
- Optimizer directives
 - access method 11-4
 - ALL_ROWS 11-7
 - altering query plan 11-7
 - AVOID_EXECUTE 13-1
 - AVOID_FULL 11-3, 11-4
 - AVOID_HASH 11-6
 - AVOID_INDEX 11-4
 - AVOID_INDEX_SJ 10-9, 11-4
 - AVOID_NL 11-3, 11-6
 - effect on views 11-5
 - embedded in queries 11-1
 - EXPLAIN 11-10, 13-1
 - EXPLAIN AVOID_EXECUTE 11-10
 - external 11-14
 - external directives 11-1
 - FIRST_ROWS 11-7
 - FULL 11-4
 - guidelines 11-3
 - INDEX 11-4
 - INDEX_SJ 11-4
 - join order 11-3, 11-5
 - join plan 11-6
 - OPTCOMPIND 11-11
 - Optimizer directives
 - INDEX_SJ 10-9
 - ORDERED 11-3, 11-5
 - purpose 11-1
 - SPL routines 11-12
 - table scan 11-3
 - types 11-3
 - USE_HASH 11-6
 - USE_NL 11-6
 - using DIRECTIVES 11-11
 - using IFX_DIRECTIVES 11-11
- ORDER BY clause 10-20, 13-31
- Ordered merge 13-36
- Outer join
 - effect on PDQ 12-5
- Outer table 10-2
- Output description
 - onstat -g ssc 4-40
- Outstanding in-place alters
 - defined 6-37
 - displaying 6-37
 - performance impact 6-37
- Overloaded disks A-1

P

- Page
 - cleaning 5-40
 - memory 1-10
 - obtaining size 6-5
 - specifying size for a standard dbspace 4-10, 7-6
 - unnecessary cleaning 5-28
- Page size 4-10, 6-5

- Page size (*continued*)
 - obtaining 4-3
- Paging
 - defined 1-10
 - DS_TOTAL_MEMORY 12-10
 - expected delay 1-10
 - monitoring 2-2, 4-13
 - RA_PAGES configuration parameter 5-28
 - RA_THRESHOLD configuration parameter 5-28
 - RESIDENT configuration parameter 4-2
- Parallel
 - access to table and simple large objects 5-19
 - backup and restore 5-42
 - executing UDRs 13-37
 - index builds 12-3
 - inserts and DBSPACETEMP 5-8, 12-2
 - joins 12-9
 - scans 12-19, 13-37
 - sorts
 - PDQ priority 13-32
 - when used 5-12
- Parallel database queries
 - allocating resources 12-7
 - controlling resources 12-13
 - effect of table fragmentation 12-1
 - fragmentation 9-1
 - gate information 12-15
 - how used 12-2
 - MGM resources 12-15
 - monitoring resources 12-15
 - monitoring resources allocated 12-14, 12-15
 - priority
 - effect of remote database 12-5
 - queries that do not use PDQ 12-4
 - remote tables 12-5
 - scans 3-12
 - SET PDQPRIORITY statement 12-13
 - SPL routines 12-5
 - SQL 9-1
 - statements affected by PDQ 12-4
 - triggers 12-3, 12-4, 12-5
 - user-defined routines 13-37
 - using 12-1
- Parallel processing
 - fragmentation 9-8, 12-1
 - MGM control of resources 12-6
 - ON-Bar utility 5-42
 - PDQ threads 12-1
 - user-defined routines 13-37
- Parallel UDRs
 - defined 12-4, 13-37
 - enabling 13-37
 - sample query 13-37
 - when to use 13-37
- Partitioning
 - defined 9-1
- Partitions
 - creating in a detached index 9-11
 - creating in a fragmented index 9-10
 - creating in an attached index 9-10
 - for storing multiple fragments of the same index 7-15
 - for storing multiple fragments of the same table 6-29
- PC_HASHSIZE configuration parameter 10-32, 10-33
- PC_POOLSIZE configuration parameter 10-32, 10-33
- PDQ priority
 - DEFAULT tag 12-7
 - determining parallelism 12-9

- PDQ priority (*continued*)
 - effect of remote database 12-9
 - effect on parallel execution 12-7
 - effect on sorting memory 7-13
 - maximum parallel processing 12-9
 - outer joins 12-9
 - parallel execution limits 12-9
 - SET PDQPRIORITY statement 12-13
 - SPL routines 12-10
 - PDQPRIORITY
 - environment variable
 - requesting PDQ resources 12-7
 - limiting PDQ priority 12-8
 - PDQPRIORITY configuration parameter
 - effect of outer joins 12-5
 - PDQPRIORITY environment variable
 - adjusting the value 12-7
 - for UPDATE STATISTICS 13-19
 - limiting PDQ priority 12-7, 12-8
 - limiting resources 3-4
 - parallel sorts 13-32
 - setting PDQ priority 7-13
 - Peak loads 1-7
 - Performance
 - basic approach to measurement and tuning 1-1
 - capturing data 2-2
 - contiguous extents 5-21, 6-20
 - create a history 2-2
 - dropping indexes for updates 7-10
 - dropping indexes to speed modifications 6-32
 - effect of
 - contiguous disk space 5-21, 6-13, 6-20
 - contiguous extents 6-25
 - data mismatch 10-27
 - disk access 10-24, 10-25, 13-30
 - disk I/O 5-1
 - duplicate keys 7-9
 - filter expression 13-3
 - filter selectivity 10-19
 - indexes 7-8
 - redundant data 6-42
 - regular expressions 13-3
 - sequential access 13-30
 - simple-large-object location 6-8
 - table size 13-30
 - goals 1-3
 - improved by
 - contiguous extents 5-21, 6-20
 - specifying optimization level 13-34
 - temporary table 13-32
 - index time during modification 7-7
 - measurements 1-3
 - slowed by data mismatch 10-27
 - slowed by duplicate keys 7-9
 - tips 1-1
 - tips for a small database 1-2
 - Performance problems
 - early indications 1-1
 - sudden performance loss 14-13
 - PHYSBUFF configuration parameter 4-2, 4-17, 5-35
 - PHYSFILE configuration parameter 5-33
 - Physical log
 - buffer size 4-17
 - configuration parameters that affect 5-8
 - effects of
 - checkpoints on sizing 5-33
 - frequent updating 5-33
 - Physical log (*continued*)
 - increasing size 4-10, 5-33
 - mirroring 5-7
 - overflow during fast recovery 5-44
 - when you have non-default page sizes 4-10
 - Playback process 14-3
 - PLOG_OVERFLOW_PATH configuration parameter 5-44
 - Poll threads
 - added with network VP 3-19
 - configuring with NETTYPE configuration parameter 3-1, 3-13
 - connections per 3-14
 - for connection 3-14, 3-19
 - NETTYPE configuration parameter 3-14
 - Priority
 - setting on Windows 3-3
 - Probe table, directives 11-6
 - PSORT_DBTEMP environment variable 5-11
 - PSORT_DTEMP environment variable 5-8
 - PSORT_NPROCS environment variable 3-4, 5-12, 7-13, 13-32
- ## Q
- Quantum, of memory 3-12, 4-14, 12-6, 12-14, 12-15
 - Queries
 - improving performance 13-19
 - resources allocated 12-14
 - response time and throughput 1-6
 - temporary files 9-5, 13-32
 - Query plan
 - with index self-join 10-7
 - Query plans 10-1
 - all rows 11-7
 - altering with directives 11-3, 11-7
 - autoindex path 13-19
 - avoid query execution 11-10
 - chosen by optimizer 11-3
 - collection-derived table 10-15
 - disk accesses 10-5
 - displaying 10-9, 13-29
 - first-row 11-7
 - fragment elimination 9-28, 12-19
 - how the optimizer chooses one 11-2
 - indexes 10-6
 - join order 11-7
 - pseudocode 10-4, 10-5
 - restrictive filters 11-2
 - row access cost 10-24
 - time costs 10-3, 10-22, 10-23, 10-24
 - Query statistics 10-10
 - Query-tree tool (onperf) 14-3, 14-11
- ## R
- R-tree index
 - defined 7-2, 7-20
 - using 7-16
 - RA_PAGES configuration parameter 5-28
 - RA_THRESHOLD configuration parameter 5-28
 - Range expression, defined 9-14
 - Range scan mode 13-26
 - Raw disk space 5-2, 5-3
 - Read cache rate 4-13
 - Read-ahead
 - configuring 5-26, 5-28
 - defined 5-26

- Reclaiming empty extent space 6-27
- Recovery time objective
 - Recovery point objective 5-36
- Redundant data, introduced for performance 6-42
- Redundant pairs, defined 10-9
- Regular expression, effect on performance 13-3
- Relational model
 - denormalizing 6-39
- Remainder pages
 - tables 6-5
- Remote database
 - effect on PDQPRIORITY 12-5
- RENAME statement 10-30
- Repeatable Read isolation level 5-26, 8-7, 10-21
- Residency 4-19
- RESIDENT configuration parameter 4-19
- Resident portion of shared memory 4-2, 4-3
- Resizing table to reclaim empty space 6-27
- Resource utilization
 - capturing data 2-2
 - CPU 1-9
 - defined 1-8
 - disk 1-11
 - factors that affect 1-12
 - memory 1-10
 - operating-system resources 1-7
 - performance 1-7
- Resources
 - critical 1-7
- Response time
 - actions that determine 1-5
 - contrasted with throughput 1-6
 - improving with MaxConnect 3-25
 - improving with multiplexed connections 3-24
 - measuring 1-6
- Response times
 - SQL statement cache 13-39
- Root dbspace
 - mirroring 5-6
- Root index page 7-1
- ROOTNAME configuration parameter 5-8
- ROOTOFFSET configuration parameter 5-8
- ROOTPATH configuration parameter 5-8
- ROOTSIZE configuration parameter 5-8
- Round-robin distribution scheme 9-6
- Round-robin fragmentation, smart large objects 9-6
- Row access cost 10-24
- Row pointer
 - attached index 9-10
 - detached index 9-11
 - in fragmented table 9-5
 - space estimates 7-4, 9-5
- RTO_SERVER_RESTART configuration parameter 5-30, 5-31, 5-41, 5-44
- RTO_SERVER_RESTART policy 5-30, 5-33, 5-36

S

- sar command 2-2, 4-13
- Saturated disks 5-1
- sbspace extents
 - performance 5-21, 6-12
- SBSPACENAME
 - configuration parameter 5-13
 - logging 5-13
- SBSPACENAME configuration parameter 5-20
- sbspaces
 - configuration impacts 5-19
 - creating 5-21
 - defined 5-6
 - estimating space 6-10
 - extent 5-21, 5-22
 - metadata requirements 6-10
 - metadata size 6-11, 6-12
 - monitoring 6-13
 - monitoring extents 6-14, 6-15
- SBSPACETEMP
 - no logging 5-13
- SBSPACETEMP configuration parameter 5-13, 5-14
- Scans
 - DS_MAX_QUERIES 12-6
 - DS_MAX_SCANS 12-6
 - first-row 10-14
 - key-only 10-1
 - light 5-26
 - lightweight I/O 5-22
 - limited by MAX_PDQPRIORITY 3-11
 - limiting number 12-11
 - limiting number of threads 12-11
 - limiting PDQ priority 12-11
 - memory-management system 1-10
 - parallel 12-19
 - parallel database query 3-12
 - read-ahead I/O 5-26
 - sequential 5-26
 - skip-duplicate-index 10-14
 - table 10-1, 10-2, 13-19
 - threads 3-9, 3-11, 3-12
- Scheduler
 - automated UPDATE STATISTICS tasks 13-7
- Scheduling facility, cron 2-3, 4-7
- Screen reader
 - reading syntax diagrams B-1
- Secondary-access methods
 - DataBlade modules 7-16
 - defined 7-16, 7-20
 - defined by database server 7-17
 - generic B-tree 7-17
 - R-Tree 7-20
- SELECT statements
 - accessing data 9-4
 - collection-derived table 10-15
 - column filter 10-5
 - join order 10-3
 - materialized view 10-35
 - redundant join pair 10-9
 - row size 6-6
 - SPL routines and directives 11-12
 - three-way join 10-4
 - trigger performance 10-35
 - triggers 10-35
 - using directives 11-1, 11-3
- Selective filter
 - dimensional table 13-20
- Selectivity
 - column, and filters 7-8
 - defined 10-19
 - estimates for filters 10-19
 - indexed columns 7-9
 - user-defined data 13-37, 13-38
- Semaphores
 - allocated for UNIX 3-1
- Semi-join, defined 10-2

- SEMMNI UNIX configuration parameter 3-1, 3-2
- SEMMNS UNIX configuration parameter 3-1
- SEMMSL UNIX configuration parameter 3-1
- Sequential
 - access costs 10-24
 - scans 5-26, 13-30
- Service time formula 1-8
- Session
 - monitoring 2-14, 13-46, 13-47, 13-50
 - monitoring memory 4-4, 4-43, 13-47, 13-50
 - setting optimization goal 13-34
- SET DATASKIP statement 9-3
- SET ENVIRONMENT OPTCOMPIND 10-21, 12-12
- SET ENVIRONMENT OPTCOMPIND command 3-11
- SET EXPLAIN
 - collection scan 10-15
 - complex query 10-11
 - converted data 10-27
 - data mismatch 10-28
 - decisions of query optimizer 12-12
 - determine UPDATE STATISTICS 13-15
 - directives 11-7
 - fragments scanned 9-28
 - how data accessed 9-4
 - join rows returned 13-15
 - key-first scan 10-13
 - optimizer access paths 10-12
 - optimizing 13-36
 - order of tables accessed 10-12
 - output
 - sqexplain.out (UNIX) 10-10
 - sqexpln file (Windows) 10-10
 - statistics 10-10
 - parallel scans 12-19
 - PDQ priority levels 12-19
 - query plan 10-9, 12-12
 - resources required by query 13-1
 - secondary threads 12-19
 - serial scans 12-19
 - simple query 10-11
 - SPL routines 10-30
 - subquery 10-14
 - using 10-9, 10-14
- SET INDEX COMPRESSION command 13-27
- SET ISOLATION statement 8-5, 8-9
- SET LOCK MODE statement 8-2, 8-5, 8-7, 8-10, 8-13, 8-15, 9-26
- SET LOG statement 1-4
- SET OPTIMIZATION statement
 - setting ALL_ROWS 13-34
 - setting FIRST_ROWS 13-34
 - setting HIGH or LOW 13-34
 - SPL routines 10-31
- SET PDQPRIORITY statement
 - application 12-7, 12-13
 - DEFAULT tag 12-7, 12-13
 - in SPL routine 12-10
 - limiting CPU VP utilization 3-4
 - sort memory 13-19
- SET STATEMENT CACHE statement 4-30, 13-41
- SET TRANSACTION statement 8-5
- Shared memory
 - allowed per query 4-14
 - amount for sorting 7-13, 7-14
 - connection 3-14, 3-19
 - freeing 4-7
 - message portion 4-1, 4-3, 4-6
- Shared memory (*continued*)
 - resident portion 4-1, 4-2, 4-3
 - size limit 4-20
 - size of segments 4-19
 - virtual portion 4-1, 4-2, 4-4, 4-9
- SHMADD configuration parameter 4-2
- SHMBASE configuration parameter 4-8
- SHMMAX configuration parameter 4-6, 4-19, 4-21
- SHMMNI operating-system configuration parameter 4-6
- SHMSEG operating-system configuration parameter 4-6
- SHMSIZE operating-system configuration parameter 4-6
- SHMTOTAL configuration parameter 3-23, 4-2, 4-20
- SHMVIRT_ALLOCSEG configuration parameter 4-21
- SHMVIRT_SIZE configuration parameter 4-2, 4-4, 4-21
- Short rows, reducing disk I/O 6-40
- Shortcut keys
 - keyboard B-1
- Simple large objects
 - blobpage size 5-15
 - blobspace 5-15
 - configuration effects 5-15
 - disk I/O 5-15
 - estimating number of blobpages 6-8
 - estimating tblspace pages 6-9
 - how stored 6-8
 - in blobspace 5-15
 - in dbspace 6-5
 - locating 6-8
 - logging 5-15
 - logical-log size 5-37
- Optical Subsystem 5-24
- SINGLE_CPU_VP configuration parameter 3-10
- Smart large objects
 - ALTER TABLE 6-19
 - buffer pool 4-13, 5-20, 5-22
 - buffer pool usage 6-17
 - buffering recommendation 5-23
 - changing characteristics 6-19
 - CREATE TABLE statement 6-19
 - data integrity 6-17
 - DataBlade API functions 5-19, 5-21, 6-17, 6-22, 8-19
 - disk I/O 5-19
 - ESQL/C functions 5-19, 5-21, 6-17, 6-22, 8-19
 - estimating space 6-10
 - extent size 5-21, 5-22, 6-17, 6-22
 - fragmentation 6-17, 9-6
 - I/O operations 5-22, 6-12
 - I/O performance 4-13, 5-20, 5-22, 6-12
 - last-access time 6-17
 - lightweight I/O 4-13, 5-22, 5-23
 - lock mode 6-17
 - logging status 6-17
 - logical-log size 5-38
 - mirroring chunks 5-6
 - monitoring 6-13
 - sbspace name 6-17
 - sbspaces 5-19
 - setting isolation levels 8-19
 - size 6-17
 - specifying characteristics 6-19
 - specifying size 5-21, 6-22
 - storage characteristics 6-17
- SMI tables
 - monitoring latches 4-45
 - monitoring sessions 13-52
 - monitoring virtual processors 3-22
- Snowflake schema 13-20

- Sort memory 7-14
- Sorting
 - avoiding with temporary table 13-32
 - costs 10-23
 - DBSPACETEMP configuration parameter 5-8
 - DBSPACETEMP environment variable 5-8
 - effect of PDQ priority 13-19
 - effect on performance 13-31
 - estimating temporary space 7-14
 - memory estimate 7-14
 - PDQ priority for 7-14
 - query-plan cost 10-1
 - sort files 5-8
 - triggers in a table hierarchy 10-35
- Space
 - reducing on disk 6-43, 6-44
- SPL 10-32
- SPL routines
 - automatic reoptimization 10-30
 - display query plan 10-30
 - effect
 - of PDQ 12-5
 - of PDQ priority 12-10
 - optimization level 10-31
 - query response time 1-5
 - when executed 10-32
 - when optimized 10-29
- sqexplain.out file 10-10
- sqexpln.out file 10-10
- SQL statement cache
 - changing size 4-36
 - cleaning 4-35
 - defined 13-39
 - effect on prepared statements 13-40
 - enabling 13-41
 - exact match 13-42
 - flushing 13-40
 - hits 4-23, 4-30, 4-32, 4-33, 4-34, 4-37, 4-38, 4-40
 - host variables 13-40
 - memory 4-23
 - memory limit 4-30, 4-37
 - monitoring 4-32, 4-33, 4-34, 4-40
 - monitoring dropped entries 13-45
 - monitoring pools 4-38, 4-39
 - monitoring session memory 13-42, 13-43, 13-44, 13-45
 - monitoring size 4-35, 4-36, 4-39
 - monitoring statement memory 2-14, 13-42, 13-45
 - nonshared entries 4-34
 - number of pools 4-38
 - performance benefits 4-29, 13-39
 - response times 13-39
 - size 4-23, 4-35, 4-37
 - specifying 13-41
 - STMT_CACHE configuration parameter 4-30, 13-41
 - STMT_CACHE environment variable 13-41
 - STMT_CACHE_SIZE configuration parameter 4-36
 - when to enable 13-41
 - when to use 13-40
- SQLCODE field of SQL Communications Area 6-41
- sqlhosts file
 - client buffer size 3-18
 - multiplexed option 3-24
- sqlhosts file or registry
 - connection type 3-13, 3-14
 - connections 4-21
 - number of connections 5-37
- SQLWARN array 5-29
- Stack
 - specifying size 4-22
- STACKSIZE configuration parameter 4-22
- STAGEBLOB configuration parameter 5-24
 - defined 5-25
- Staging area
 - optimal size for blobspace 5-25
- standards xvii
- Star join, defined 13-20
- Star schema 13-20
- Statistics
 - automatically generated 13-11
- Status tool (onperf) 14-3, 14-11
- STMT_CACHE environment variable 13-41
- STMT_CACHE_HITS configuration parameter 4-23, 4-30, 4-32, 4-33, 4-34, 4-37, 4-38, 4-40
- STMT_CACHE_NOLIMIT configuration parameter 4-23, 4-30
- STMT_CACHE_NUMPOOL configuration parameter 4-38
- STMT_CACHE_SIZE configuration parameter 4-23, 4-35, 4-37
- Storage characteristics
 - Smart large objects
 - last-access time 6-17
 - system default 6-17
- Storage spaces
 - for encrypted values 4-45, 10-28
- Storage statistics
 - blobpages 5-17
 - blobspaces 5-17
- Stored Procedure Languages 10-32
- Strategy functions
 - secondary-access methods 7-23
- Strings
 - expelling long 6-40
- Structured Query Language
 - ALTER FRAGMENT statement 6-28
 - ALTER INDEX statement 6-26, 6-27, 7-9
 - TO CLUSTER clause 6-26
 - ALTER TABLE statement 6-20, 6-27
 - changing extent sizes 6-22
 - changing sbspace characteristics 6-19
 - sbspace fragmentation 9-6
 - COMMIT WORK statement 1-4
 - CONNECT statement 5-2
 - CREATE CLUSTER INDEX statement 7-9
 - CREATE FUNCTION statement 3-5
 - selectivity and cost 13-38
 - CREATE INDEX statement
 - attached index 9-10
 - detached index 9-11
 - generic B-tree index 7-17
 - TO CLUSTER clause 6-26
 - CREATE PROCEDURE statement, SQL optimization 10-29
 - CREATE TABLE statement
 - blobspace assignment 5-15
 - extent sizes 6-20
 - fragmentation 9-10, 9-11
 - lock mode 8-4
 - PUT clause 6-19
 - sbspace characteristics 6-19
 - sbspace fragmentation 9-6
 - simple large objects 6-8
 - system catalog table 5-2
 - TEMP TABLE clause 5-8, 5-13
 - CREATE TEMP TABLE statement 9-13
 - DATABASE statement 5-2
 - EXECUTE PROCEDURE statement 10-32
 - EXTENT SIZE clause 6-20

Structured Query Language (*continued*)

- FRAGMENT BY clause 9-9
- GROUP BY clause 10-20
 - MGM memory 12-6
- INSERT statements 9-6
- LOAD and UNLOAD statements 6-1, 6-25, 6-28, 7-10
- MODIFY EXTENT SIZE clause 6-20
- MODIFY NEXT SIZE clause 6-20, 6-22
- NEXT SIZE clause 6-20
- optimizer directives 11-3
- ORDER BY clause 10-20
- RENAME statement 10-30
- SELECT statements
 - collection-derived tables 10-15
 - column filter 10-5
 - join order 10-3
 - materialized view 10-35
 - redundant join pair 10-9
 - row size 6-6
 - SPL routines and directives 11-12
 - three-way join 10-4
 - triggers 10-35
 - using directives 11-1, 11-3
- SET DATASKIP statement 9-3
- SET EXPLAIN statement 9-28
 - accessing data 9-4
 - collection scan 10-15
 - complex query 10-11
 - directives 11-7
 - flattened subquery 10-14
 - optimizer decisions 12-12
 - order of tables 10-12
 - show query plan 10-9
 - simple query 10-11
- SET EXPLAIN statement directives 11-7
- SET ISOLATION statement 8-5
- SET LOCK MODE statement 8-2, 8-5, 8-7, 8-10, 8-13, 8-15
- SET OPTIMIZATION statement 13-34
- SET PDQPRIORITY statement 3-4
 - DEFAULT tag 12-7, 12-13
 - in application 12-7, 12-13
 - in SPL routine 12-10
 - sort memory 13-19
- SET STATEMENT CACHE 4-30, 13-41
- SET TRANSACTION statement 8-5
- TO CLUSTER clause 6-26, 6-27
- UPDATE STATISTICS statement 4-2, 10-18, 11-3
 - and directives 11-3, 11-12
 - creating data distributions 13-13
 - data distributions 10-18
 - effect of PDQ 12-4
 - guidelines to run 13-11, 13-19
 - HIGH mode 13-11, 13-14, 13-15, 13-16, 13-17
 - LOW mode 13-11, 13-12, 13-37
 - MEDIUM mode 13-13, 13-16
 - multiple column distributions 13-19
 - on join columns 13-15
 - on user-defined data columns 13-16
 - optimizing SPL routines 12-10
 - query optimization 13-11
 - reoptimizing SPL routines 10-30
 - updating system catalog 10-18, 13-11
 - user-defined data 13-37
- WHERE clause 10-20, 13-2, 13-3
- Subquery 12-9
 - flattening 10-14
 - rewriting 10-14

- Support functions
 - description for secondary access method 7-23
- Swap device 1-10
- Swap space 1-10, 4-6
- Swapping, memory 1-10, 12-10
- Symbol table
 - building 6-41
- Syntax diagrams
 - reading in a screen reader B-1
- sysdirectives system catalog table 11-1
- sysmaster database 2-3
- sysprofile table 8-12
- System catalog tables
 - data distributions 10-18
 - optimizer use of 10-18
 - sysams 7-18, 7-25
 - syscolumns 13-13, 13-16
 - sysdistrib 13-13, 13-16
 - sysfragments 9-11, 9-28
 - sysopclasses 7-25
 - sysprocbody 10-29
 - sysprocedure 10-29
 - sysprocplan 10-29, 10-30
 - systables 7-15, 10-30
 - systrigbody 10-33
 - systriggers 10-33
 - updated by UPDATE STATISTICS 10-18
- System resources, measuring utilization 1-7
- System-monitoring interface 2-3

T

- Table
 - adding redundant data 6-42
 - assigning to dbspace 6-1
 - companion, for long strings 6-41
 - configuring I/O for 5-26
 - cost of access 13-30
 - denormalizing 6-40
 - division by bulk 6-41
 - estimating
 - blobpages in tblspace 6-8
 - data page size 6-5
 - size with fixed-length rows 6-5
 - size with variable-length rows 6-7
 - expelling long strings 6-40
 - fact 13-20
 - frequently updated attributes 6-41
 - infrequently accessed attributes 6-41
 - isolating high-use 6-2
 - locks 8-3
 - managing
 - extents 6-20
 - managing indexes for 7-6
 - nonfragmented 6-5
 - partitioning, defined 9-1
 - placement on disk 6-1
 - reducing contention between 6-2
 - redundant and derived data 6-42
 - remote, used with PDQ 12-5
 - rows too wide 6-41
 - shorter rows 6-40
 - size estimates 6-5
- Table
 - splitting if too wide 6-41
- temporary 6-4

- Table distributions
 - automated UPDATE STATISTICS 13-6
- Table hierarchy
 - SELECT triggers 10-35
- Table scan
 - defined 10-1
 - nested-loop join 10-2
 - OPTCOMPIND 3-10
 - replaced with composite index 13-19
- TAPEBLK configuration parameter 5-43
- TAPEDEV configuration parameter 5-43
- TAPESIZE configuration parameter 5-43
- Tblspace
 - attached index 9-11
 - defined 6-5
 - extent size for tblspace tblspace 6-10
 - monitoring
 - active tblspaces 6-23
 - simple large objects 6-8
- TBLTBLFIRST configuration parameter 6-10
- TBLTBLNEXT configuration parameter 6-10
- TCP connections 3-14, 3-19
- TCP/IP buffers 3-16
- TEMP or TMP user environment variable 5-8
- TEMP TABLE clause of the CREATE TABLE statement 5-8, 5-13, 9-13
- Temporary dbpace
 - creating 7-13
 - DBSPACETEMP configuration parameter 5-11
 - DBSPACETEMP environment variable 5-11
 - for index builds 7-13, 7-14
 - onspaces -t 5-10
 - optimizing 5-10
 - root dbpace 5-8
- Temporary sbpace
 - configuring 5-13
 - onspaces -t 5-14
 - optimizing 5-14
 - S BSPACETEMP configuration parameter 5-14
- Temporary smart large object
 - LO_TEMP flag 5-13
- Temporary tables
 - configuring 5-8
 - DBSPACETEMP configuration parameter 5-8, 5-11
 - DBSPACETEMP environment variable 5-11
 - decision-support queries 9-4
 - Decision-support queries
 - use of temporary files 9-4
 - explicit 9-13
 - fragmentation 9-13
 - in root dbpace 5-5
 - speeding up a query 13-32
 - Temporary dbpace
 - decision-support queries 9-4
- TEMPTAB_NOLOG configuration parameter 5-40
- TEXT data type 6-40
 - in blobpace 5-15
 - in table-size estimate 6-5
 - locating 6-8
 - memory cache 5-24
 - on disk 6-8
 - parallel access 5-19
 - staging area 5-24
- Thrashing, defined 1-10
- Thread-safe
 - UDRs 13-38
- Threads
 - DS_MAX_SCANS configuration parameter 12-6
 - MAX_PDQPRIORITY 3-11
 - monitoring 2-7, 4-4, 13-46, 13-47, 13-48, 13-49
 - page-cleaner 5-7
 - primary 12-1, 12-17
 - secondary 12-1, 12-19
 - sqlxec 5-40, 12-17
- Throughput
 - benchmarks 1-4
 - capturing data 1-4
 - contrasted with response time 1-6
 - measure of performance 1-3
 - measured by logged COMMIT WORK statements 1-4
- Tightly coupled 13-53, 13-55
- Time
 - getting current in ESQ/C 1-7
 - getting user, processor and elapsed 1-7
 - getting user, system, and elapsed 1-6
- time command 1-6
- Timing
 - commands 1-6
 - functions 1-7
 - monitoring 1-7
- TO CLUSTER
 - clause 6-26, 6-27
- TPC-A, TPC-B, TPC-C, and TPC-D benchmarks 1-4
- Transaction processing
 - improving using B-tree scanner 13-21
- Transaction Processing Performance Council 1-4
- Transaction throughput, effects of MAX_PDQPRIORITY 3-11
- Transactions
 - cost 1-7
 - loosely coupled 13-53
 - monitoring 2-13, 13-47, 13-53
 - monitoring global transactions 13-53, 13-55
 - rate 1-3
 - rollback 7-7
 - tightly-coupled mode 13-53, 13-55
- Triggers
 - and PDQ 12-3, 12-4, 12-5
 - behavior in table hierarchy 10-35
 - defined 10-33
 - effect of PDQ 12-5
 - performance 10-34
 - row buffering 10-35
- Troubleshooting
 - example of identifying overloaded disks A-1
 - performance degradation 14-13
 - sudden performance loss 14-13
- TRUNCATE STATEMENT 6-28
- Truncating tables 6-28

U

- UDR cache 4-43
 - buckets 10-32, 10-33
 - number of entries 10-32, 10-33
- Unbuffered devices 10-24
- Unbuffered logging 5-7
- UNIX
 - cron scheduling facility 2-3
 - iostat command 2-2
 - network protocols 3-13
 - ps command 2-2
 - sar command 2-2
 - SEMMNI configuration parameter 3-1, 3-2

- UNIX (*continued*)
 - SEMMNS configuration parameter 3-1
 - SEMMSL configuration parameter 3-1
 - sqexplain.out file 10-10
 - time command 1-6
 - vmstat command 2-2
- Update cursor 8-9
- UPDATE STATISTICS statement
 - and PDQ priority 13-17
 - automatically generated, viewing 13-10
 - automatically running 13-6
 - creating data distributions 13-13
 - data distributions 10-18
 - directives 11-3, 11-12
 - effect of PDQ 12-4
 - effect on virtual portion of memory 4-2
 - equivalent automatic operation 13-11
 - generating with ISA 13-11
 - guidelines to run 13-11, 13-19
 - HIGH mode 11-3, 13-11, 13-14, 13-15, 13-16, 13-17
 - improving ALTER FRAGMENT ATTACH performance 9-23
 - LOW mode 13-11, 13-12, 13-37
 - MEDIUM mode 13-13, 13-16
 - multiple column distributions 13-19
 - not needed when statistics are generated automatically 13-11
 - on join columns 13-15
 - on user-defined data columns 13-16
 - optimizing SPL routines 11-12, 12-10
 - providing information for query optimization 10-18
 - query optimization 13-11
 - reoptimizing SPL routines 10-30
 - updating system catalog 10-18, 13-11
 - user-defined data 13-37, 13-39
 - using on very large databases 13-17
- USELASTCOMMITTED configuration parameter 8-6
- User-defined aggregates
 - parallel execution 13-37
- User-defined data types
 - B-tree index 7-1
 - cost of routine 13-37, 13-38
 - data distributions 13-16
 - generic B-tree index 7-18
 - opaque 7-16
 - optimizing queries on 13-37
 - selectivity 13-37, 13-38
 - UPDATE STATISTICS 13-16
- User-defined index
 - DataBlade modules 7-2, 7-16
- User-defined routine cache
 - changing size 10-32
 - contents 10-32
- User-defined routines
 - negator function 13-39
 - parallel execution 12-4, 13-37
 - query filters 13-2
 - query response time 1-5
 - statistics 13-39
 - thread-safe 13-38
- User-defined selectivity function 13-2
- User-defined statistics 13-39
- Users, types of xii
- USING clause, CREATE INDEX statement 7-19
- Utilities
 - Contiguous
 - extents, allocation 6-22
- Utilities (*continued*)
 - DB-Access 6-25
 - dbload 6-25, 7-10
 - dbschema 9-4, 9-7, 13-17
 - ISA 4-45
 - capabilities 2-5
 - defined 2-5
 - generating UPDATE STATISTICS statements 13-11
 - monitoring I/O Utilization 2-10
 - monitoring user sessions 2-13
 - starting virtual processors 3-19
 - monitoring performance 2-3
 - ON-Monitor utility 3-19
 - onaudit 5-45
 - oncheck
 - pB option 2-11
 - pe option 2-11, 6-14, 6-25, 6-26
 - pk option 2-11
 - pK option 2-11
 - pl option 2-11
 - pL option 2-11
 - pp option 2-11
 - pP option 2-11
 - pr option 2-11, 6-37
 - ps option 2-11
 - pS option 2-11, 6-15
 - pt option 2-11, 6-5
 - pT option 2-11, 6-37
 - and index sizing 7-4
 - introduced 2-11
 - monitoring table growth 6-22
 - onload and onunload 5-43, 6-1, 6-25, 6-28
 - onlog 1-4, 2-12
 - onmode
 - F option 4-7
 - p option 3-19
 - P option 3-8
 - W option to change STMT_CACHE_NOLIMIT 4-37
 - forced residency 4-19
 - shared-memory connections 3-1
 - onmode and PDQ 12-15
 - onparams 5-5, 5-7
 - onperf
 - activity tools 14-12
 - data flow 14-1
 - defined 14-1
 - graph tool 14-5
 - metrics 14-13
 - query-tree tool 14-11
 - replaying metrics 14-3
 - requirements 14-3
 - saving metrics 14-2
 - starting 14-4
 - status tool 14-11
 - tools 14-3
 - user interface 14-5
 - onspaces
 - Df BUFFERING tag 5-23
 - Df option 5-21, 6-19
 - S option 6-19
 - t option 5-10, 5-14, 6-4, 7-13
 - EXTENT_SIZE flag for sbspaces 5-21
 - sbspaces 5-19
 - onstat utility
 - option 2-6
 - a option 2-6
 - b option 2-6, 4-3, 4-10, 6-5, 6-8

Utilities (continued)

onstat utility (continued)

- d option 3-21, 6-11, 6-12
- F option 5-40
- g act option 13-47, 13-49
- g afr option 3-18
- g ath option 3-9, 12-17, 13-47, 13-48, 13-49
- g cac option 4-33, 10-33
- g cac stmt option 4-33
- g dic option 4-24
- g dsc option 4-27
- g glo option 3-20
- g iof option 2-10
- g iog option 2-10
- g ioq option 2-10, 3-8, 3-21
- g iov option 2-10
- g mem option 2-8, 13-47, 13-50
- g mgm option 2-8, 12-6, 12-14
- g ntm option 3-17
- g ntu option 3-17
- g option 2-6
- g osi option 2-8
- g ppf option 9-27
- g prc option 10-33
- g rea option 3-20
- g scn option 5-26
- g seg option 2-8, 4-5, 4-19
- g ses option 2-8, 2-14, 3-9, 4-4, 12-18, 13-47, 13-50
- g smb option 6-13
- g smb s option 6-16
- g spi option 4-32
- g sql option 2-14
- g ssc all option 4-32
- g ssc option 4-32, 13-45
- g stm option 2-8, 4-4, 4-43, 13-47, 13-50
- g sts option 4-4
- k option 8-11, 8-13
- l option 2-6
- m option 5-31
- O option 5-24
- p option 1-4, 2-6, 4-13, 4-44, 8-12, 8-15
- P option 2-6
- R option 2-6
- s option 4-45
- u option 2-6, 4-4, 8-12, 8-13, 12-17, 13-47
- x option 2-6
- monitoring buffer pool 4-13
- monitoring threads per session 3-9

ontape utility 5-43

Utilization

- capturing data 2-2
- CPU 1-9, 3-1, 3-24
- defined 1-7
- disk 1-11
- factors that affect 1-12
- memory 1-10
- service time 1-8

V

VARCHAR data type

- access plan 10-1
- byte locks 8-10
- costs 10-28
- expelling long strings 6-40
- in table-size estimates 6-7
- when to use 6-40

Variable-length rows 6-7

View

- effect of directives 11-5

Virtual memory, size 4-6

Virtual portion 4-2, 4-4, 4-21

- shared memory 4-9

Virtual processors

- adding 3-19
- class name 3-5
- CPU 3-19
- monitoring 3-19, 3-20, 3-21
- multicore processors 3-5
- NETTYPE 3-14
- network, SOC or TLI 3-19
- poll threads for 3-14, 3-19
- processor affinity 3-5
- semaphores required 3-1
- setting number of CPU VPs 3-5
- setting number of NET VPs 3-14
- starting additional 3-19
- user-defined 3-5

Visual disabilities

- reading syntax diagrams B-1

vmstat command 2-2, 4-13

VP_MEMORY_CACHE_KB configuration parameter 3-22, 3-23

VPCLASS configuration parameter

- process priority aging 3-6
- processor affinity 3-5
- setting number of AIO VPs 3-8
- setting number of CPU VPs 3-5
- setting processor affinity 3-6, 3-7
- specifying class of virtual processors 3-5

W

WHERE clause 10-20, 13-2, 13-3

Windows

- NETTYPE configuration parameter 3-14
- network protocols 3-13
- parameters that affect CPU utilization 3-3
- Performance Logs and Alerts 1-7, 2-2
- sqexpln file 10-10
- TEMP or TMP user environment variable 5-8

WORM. 5-24

Write once read many

- optical subsystem 5-24

X

X display server 14-4



Printed in USA

SC27-3618-02



Spine information:

Informix Product Family Informix **Version 11.50**

IBM Informix Performance Guide

